

COLLEZIONI D'AUTORE



manifattura completamente italiana

LISTINO PREZZI / PRICE LIST 81.2017

CURA, ATTENZIONE, TECNICHE D'AVANGUARDIA, GUSTO, STILE ED ESPERIENZA, SONO GLI INGREDIENTI DELLE COLLEZIONI D'AUTORE BELLOSTA RUBINETTERIE

GRAZIE PER LA FIDUCIA

CARE, ATTENTION, AVANTGARDE TECHNIQUE, TASTE, STYLE AND EXPERIENCE ARE THE INGREDIENTS OF THE BELLOSTA RUBINETTERIE COLLECTIONS

THANKS FOR THE TRUST



rubinetti d'autore made in Italy

RIVENDITORE | AGENTE D'AREA

RETAILER | CONTACT AREA





DECOR ITALIA
L'ARTE DEL VIVERE
IN TUTTE LE SUE MANIFESTAZIONI
ALBERTO

PALOMA

EQB DESIGN



PALOMA



TABELLA PREZZI FINITURE	pag. W-4
INFO TECNICHE	pag. W-4
INDICE / INDEX	pag. W-6
LAVABO	pag. W-10
BIDET	pag. W-15
DOCCIA INCASSO	pag. W-15
DEVIATORI INCASSO	pag. W-15
DOCCIA ESTERNO	pag. W-16
VASCA	pag. W-17
BAGNO COMPLEMENTI	pag. W-17

PREZZO FINITURE

Calcola il prezzo di listino (IVA esclusa) delle finiture diverse dal cromato, consultando la seguente tabella.

Moltiplicare il PREZZO LISTINO per il COEFFICIENTE MOLTIPLICATORE della finitura scelta, arrotondando per difetto il prezzo ottenuto (eliminare i centesimi).
ESEMPIO per ordinare art. 6005/1 in finitura dorato: codice 04-6005/1

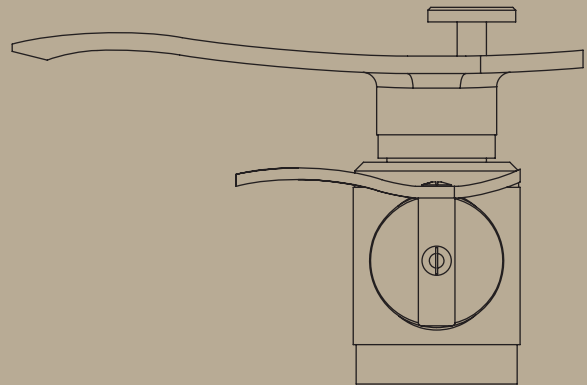
€ 422,00 (PREZZO LISTINO) x 1,80 (MOLTIPLICATORE) = € ~~759,60~~ 759,00

PRICE FINISHES

Include the list price (excluding VAT) of different finishes from chrome, consulting the following table. Multiply the PRICE LIST MULTIPLIER COEFFICIENT of the chosen finish, reducing the price obtained by deleting the centesim.

EXAMPLE to order art. 6005/1 gold finish: code 04-6005/1

€ 422,00 (LIST PRICE) x 1,80 (MULTIPLIER) = € ~~759,60~~ 759,00

FINITURE DI SERIE / STANDARD FINISHES

CODICE CODE	DESCRIZIONE FINITURA FINISH DESCRIPTION	MOLTIPLICATORE MULTIPLIER
01-	cromato / chrome	PREZZO LISTINO°
02-	cromo/oro / chrome/gold	x 1,35
04-	dorato / gold	x 1,80
08-	canna di fucile / gun barrel	x 1,80
14-	bianco / white	x 1,30
19-	nero / black	x 1,30
66-	bianco opaco / mat white	x 1,30
67-	nero opaco / mat black	x 1,30
69-	argento opaco / mat silver	x 1,45
71-	oro opaco / mat gold	x 1,80

FINITURE A RICHIESTA / ON REQUEST FINISHES

CODICE CODE	DESCRIZIONE FINITURA FINISH DESCRIPTION	MOLTIPLICATORE MULTIPLIER
03-	oro/argento / gold/silver	x 1,55
05-	bronzo satinato / satin bronze	x 1,55
06-	rame vecchio / old copper	x 1,55
07-	vecchio argento / old silver	x 1,55
10-	verderame / verdigris	NON REALIZZABILE*
11-	nero antracite / anthracite black	NON REALIZZABILE*

°PREZZO DI LISTINO / PRICE LIST

*NON REALIZZABILE / NOT MADE

ATTENZIONE! 13-OTTONE NATURALE e 88-OTTONE SISAL: finiture non protette che antichizzano naturalmente ossidando a contatto con l'umidità atmosferica.
WARNING! 13-NATURAL BRASS and 88-SISAL BRASS: unprotected finishes that naturally oxidise in contact with atmospheric humidity.

PROGETTO SU MISURA: RICHIESTE SPECIALI

I tecnici di Bellosta Rubinetterie sono, inoltre, a disposizione di architetti e designers, per offrire un servizio esclusivo: personalizzazioni di elementi in funzione di specifiche richieste estetiche o problematiche legate a vincoli progettuali, verifica della fattibilità attraverso opportuni studi CAD e sviluppo del disegno tecnico del prodotto speciale richiesto.

Per informazioni e richieste PROGETTI SU MISURA:
ufficiotecnico@bellostarubinetterie.com



progetto
sumisura

PROGETTO SU MISURA: SPECIAL REQUESTS

Engineers Bellosta Rubinetterie are also available to architects and designers, to offer an exclusive service: customizations of items according to specific aesthetic requirements or issues related to design constraints, verification of the feasibility studies and development through appropriate CAD technical design the required special product. For information and requests "SU MISURA" PROJECTS:
ufficiotecnico@bellostarubinetterie.com

CONSIGLIO TECNICO

Tutti i miscelatori della collezione PALOMA vengono collaudati nel loro funzionamento al momento dell'assemblaggio. Per garantire la durata delle cartucce nel tempo, si consiglia di spurgare bene l'impianto idraulico prima del montaggio (per rimuovere eventuali detriti) e di installare rubinetti sottolavabo con filtro:

art. 020 o 020/1 per i monofori, art. 020 e art. 029 (tubetti di collegamento con calotta) per i tre fori.

N.B.: Qualora il piano lavabo avesse uno spessore superiore a 2,5 cm specificare la misura al momento dell'ordine.

TECHNICAL ADVICE

All mixers of the PALOMA collection are perfectly tested. To guarantee the perfect functionality of the cartridge for a long time, we advise to clean the sanitary plant before installing the mixer. Moreover we advise to install angle valve with filter: art. 020 or 020/1 for single hole mixers, art. 020 and art. 029 (pipes with nut 1/2") for three holes mixers

Attention: If the lavatory top is more than cm 2,5 hick, please point it out when placing the order.

COMPOSIZIONE CODICE PER ORDINARE ARTICOLO IN FINITURA

XX - 6005/1

CODICE FINITURA
FINISH CODE

CODICE ARTICOLO
ITEM NUMBER

FORATURA DEI PIANI SANITARI

I miscelatori lavabo/bidet monoforo prevedono un foro di diametro 35 mm nel piano sanitario. Le batterie lavabo 3 fori sono dotate di vitone ceramico destro con apertura a 1/4 di giro (90°); l'interasse consigliato è di 110 mm e foratura come da schema sottostante.

DRILLING PLANS HEALTH

The sink / hole bidet mixers provide a hole diameter of 35 mm in the health plan. The sink batteries 3 holes are equipped with ceramic cartridge Right-open 1/4 turn (90°); the recommended distance is 110 mm, drilling as per the diagram below.

MONOFORO >>

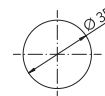

3 FORI >>

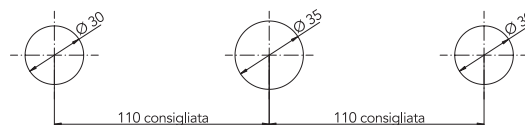

SCHEMA FUNZIONAMENTO DEVIATORI INCASSO 2/3/4 USCITE

Questi deviatori non hanno funzione di chiusura. Ruotando verso destra o sinistra si attivano le uscite. Tra 2 uscite adiacenti durante la rotazione diminuisce la portata dell'uscita iniziale ed incrementa quella della successiva. In posizione intermedia sono entrambe attive a pari portata.



SCHEME OPERATION SWITCHES FLUSH OUTPUT 2/3/4

These diverters have not closing function. By turning to the right or left activates the outputs. Between two adjacent outputs during the rotation decreases the initial output flow and increases that of the next. In position intermediate are both active at the same flow rate.

2 OUT



LAVABO



6005 pag. **W-8**
BATTERIA LAVABO TRE FORI
3 HOLE BASIN



6005/1 pag. **W-8**
GRUPPO LAVABO MONOFORO
1 HOLE BASIN GROUP

BIDET



6007 pag. **W-8**
BATTERIA BIDET TRE FORI EROGAZIONE DA BORDO
3 HOLE BIDET WITH BOARD EROGATION



6007/2 pag. **W-8**
GRUPPO BIDET MONOFORO
1 HOLE BIDET GROUP

DOCCIA INCASSO



6000/3/E + 604013 pag. **W-8**
GRUPPO INCASSO C/DEVIATORE 2 USCITE
WALL MOUNTED GROUP WITH DIVERTER 2 OUT

parti esterne / external parts: 6000/3/E
 parte incasso / built-in part: 604013

DEVIATORI INCASSO



6003/2/E + 914016 pag. **W-9**
DEVIATORE INCASSO 2 USCITE
BUILT-IN DIVERTER 2 OUT

parti esterne / external parts: 6003/2/E
 parte incasso / built-in part: 914016

DOCCIA ESTERNO



6009/1 pag. **W-9**
GRUPPO DOCCIA ESTERNO
EXTERNAL SHOWER GROUP

DOCCIA COMPLEMENTI



6003/1 pag. **136***
SUPPORTO DOCCIA DUPLEX COMPLETO
DUPLEX FULL SHOWER SUPPORT

VASCA



6001/1 pag. **W-9**
GRUPPO VASCA ESTERNO
EXTERNAL BATH GROUP



6001/3 pag. **W-9**
GRUPPO VASCA C/RACCORDI PER BORDO VASCA
EXTERNAL BATH GROUP WITH RIM CONNECTION



6001/2 pag. **W-10**
BATTERIA PER BORDO VASCA
BATH RIM



6001/20 pag. **W-10**
BATTERIA PER BORDO VASCA S/BOCCA
BATH RIM WITHOUT SPOUT

VASCA



6003 pag.W-10

BOCCA VASCA DA PARETE
WALL BATH SPOUT



PALOMA

BAGNO COMPLEMENTI



6008/E + 604003 o 604004 pag.W-10

RUBINETTO D'ARRESTO 1/2"
BUILT-IN STOP COCK 1/2"



parti esterne / external parts: 6008/E
parte incasso / built-in part: 604003 DX o 604004 SX



6008/E + 604005 o 604006 pag.W-11

RUBINETTO D'ARRESTO 3/4"
BUILT-IN STOP COCK 3/4"



parti esterne / external parts: 6008/E
parte incasso / built-in part: 604005 DX o 604006 SX

6005

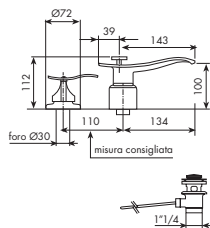

BATTERIA LAVABO TRE FORI

- > vitone ceramico 90°
- > interasse bocca 134
- > uscita libera senza aeratore
- > senza flessibili di alimentazione
- > con scarico

 **605007**
p. 151

 **605008**
p. 151

CROMATO

01-6005 € 486,00

ALTRE FINITURE

XX-6005 € 486,00 x M*

6005/1

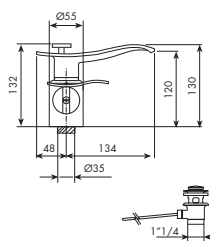

GRUPPO LAVABO MONOFORO

- > vitone ceramico 90°
- > interasse bocca 134
- > uscita libera senza aeratore
- > flessibili di alimentazione
- > con scarico

 **605007**
p. 151

 **605008**
p. 151

CROMATO

01-6005/1 € 422,00

ALTRE FINITURE

XX-6005/1 € 422,00 x M*

6007

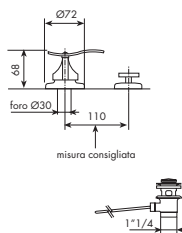

BATTERIA BIDET TRE FORI EROGAZIONE DA BORDO

- > vitone ceramico 90°
- > senza bocca
- > per ceramica con erogazione da bordo
- > senza flessibili di alimentazione
- > con scarico

 **605007**
p. 151

 **605008**
p. 151

CROMATO

01-6007 € 358,00

ALTRE FINITURE

XX-6007 € 358,00 x M*

6007/2

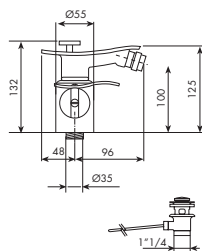

GRUPPO BIDET MONOFORO

- > vitone ceramico 90°
- > interasse bocca 96
- > aeratore snodato
- > flessibili di alimentazione
- > con scarico

 **605007**
p. 151

 **605008**
p. 151

 **034008**
p. 140

CROMATO

01-6007/2 € 422,00

ALTRE FINITURE

XX-6007/2 € 422,00 x M*

6000/3/E + 604013

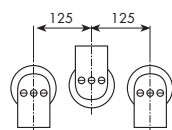

GRUPPO INCASSO C/DEVIATORE 2 USCITE

- > vitone ceramico 90°
- > deviatore a dischi ceramici 2 uscite senza chiusura
- > maniglia a leva
- > attacchi da 1/2"

 **605007**
p. 151

 **635010**
p. 131

 **035346** fino 9.2017
p. 131

PARTI ESTERNE - CROMATO

01-6000/3/E € 368,00

PARTI ESTERNE - ALTRE FINITURE

XX-6000/3/E € 368,00 x M*

PARTE INCASSO

604013 info pag. 35 € 182,00

PREZZO TOTALE € 550,00

W-8

RICAMBI IMMEDIATI



XX = CODICE FINITURA RICHIESTA: per identificare codice corretto vedi pag. W-4
M* = MOLTIPLICATORE: per calcolare il prezzo delle altre finiture vedi tabella pag. W-4

6003/2/E + 914016

DEVIATORE INCASSO 2 USCITE

- > deviatore a dischi ceramici 2 uscite senza chiusura
- > attacchi da 1/2"

 635010

p. 131

 035346 fino 9.2017

p. 131

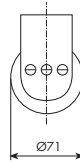

PARTI ESTERNE - CROMATO

01-6003/2/E € 136,00

PARTE INCASSO

914016 info pag. 38 € 82,00

PREZZO TOTALE € 218,00

PARTI ESTERNE - ALTRE FINITURE

XX-6003/2/E € 136,00 x M*

I DOCCIA COMPLEMENTI CONSIGLIATI SONO PRESENTI SU LISTINO REVIVRE

6003/1

6009/1

GRUPPO DOCCIA ESTERNO

- > vitone ceramico 90°
- > senza set doccia
- > attacchi da 1/2"
- > maniglia a croce porcellana decorata

 605007

p. 151

 605008

p. 151

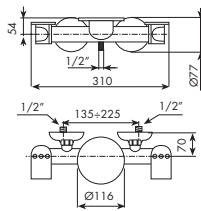

CROMATO

01-6009/1 € 443,00

ALTRE FINITURE

XX-6009/1 € 443,00 x M*

6001/1

GRUPPO VASCA ESTERNO

- > vitone ceramico 90°
- > interasse bocca 180
- > uscita libera senza aeratore
- > deviatore a trazione/spinta senza ritorno automatico
- > flessibile in PVC 150 cm
- > supporto snodato
- > attacchi da 1/2"
- > doccetta monogetto in ABS con anticalcare

 604007

p. 151

 604008

p. 151

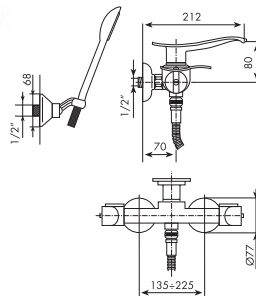

CROMATO

01-6001/1 € 619,00

ALTRE FINITURE

XX-6001/1 € 619,00 x M*

6001/3

GRUPPO VASCA C/RACCORDI PER BORDO VASCA

- > vitone ceramico 90°
- > uscita libera senza aeratore
- > interasse bocca 212
- > deviatore a trazione/spinta senza ritorno automatico
- > flessibile in metallo 150 cm
- > supporto snodato
- > attacchi da 1/2"
- > doccetta monogetto in ABS c/anticalcare

 604007

p. 151

 604008

p. 151

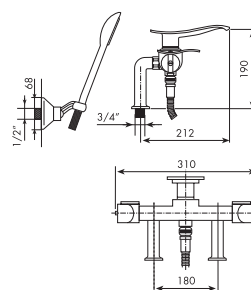

CROMATO

01-6001/3 € 696,00

ALTRE FINITURE

XX-6001/3 € 696,00 x M*

RICAMBI IMMEDIATI



XX = CODICE FINITURA RICHIESTA: per identificare codice corretto vedi pag. W-4
M* = MOLTIPLICATORE: per calcolare il prezzo delle altre finiture vedi tabella pag. W-4

6001/2

BATTERIA PER BORDO VASCA

- > vitone ceramico 90°
- > interasse bocca 180
- > uscita libera senza aeratore
- > deviatore a dischi ceramici 2 uscite
- > flessibile in PVC 150 cm
- > senza flessibili di alimentazione
- > senza scarico
- > doccetta monogetto in ABS con anticalcare

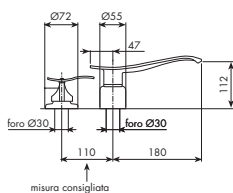
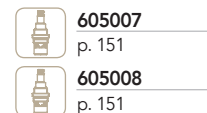

CROMATO		ALTRE FINITURE	
01-6001/2	€ 817,00	XX-6001/2	€ 817,00 x M*

6001/20

BATTERIA PER BORDO VASCA S/BOCCA

- > vitone ceramico 90°
- > senza bocca
- > deviatore a dischi ceramici 2 uscite
- > flessibile in PVC 150 cm
- > senza flessibili di alimentazione
- > senza scarico
- > doccetta monogetto in ABS con anticalcare

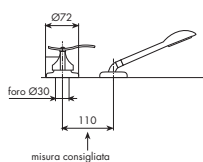

CROMATO		ALTRE FINITURE	
01-6001/20	€ 628,00	XX-6001/20	€ 628,00 x M*

6003

BOCCA VASCA DA PARETE

- > interasse bocca 245
- > erogazione libera senza aeratore
- > attacco da 1/2"

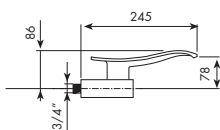

CROMATO		ALTRE FINITURE	
01-6003	€ 294,00	XX-6003	€ 294,00 x M*

6008/E + 604003 DX

RUBINETTO D'ARRESTO 1/2"

- > vitone ceramico 90°
- > ingressi da 1/2"

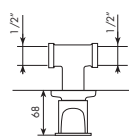
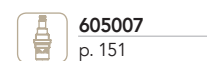

PARTI ESTERNE - CROMATO		PARTI ESTERNE - ALTRE FINITURE	
01-6008/E	€ 118,00	XX-6008/E	€ 118,00 x M*
PARTE INCASSO			
604003	info pag. 41 € 44,00		
PREZZO TOTALE		€ 162,00	

6008/E + 604004 SX

RUBINETTO D'ARRESTO 1/2"

- > vitone ceramico 90°
- > ingressi da 1/2"

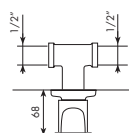
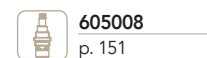

PARTI ESTERNE - CROMATO		PARTI ESTERNE - ALTRE FINITURE	
01-6008/E	€ 118,00	XX-6008/E	€ 118,00 x M*
PARTE INCASSO			
604004	info pag. 41 € 44,00		
PREZZO TOTALE		€ 162,00	

6008/E + 604005 DX

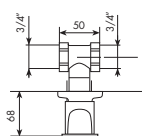

RUBINETTO D'ARRESTO 3/4"

> vitone ceramico 90°
> ingressi da 3/4"

 **605007**
p. 151

PARTI ESTERNE - CROMATO	
01-6008/E	€ 118,00
PARTE INCASSO	
604005	info pag. 41 € 65,00
PREZZO TOTALE	€ 183,00

PARTI ESTERNE - ALTRE FINITURE	
XX-6008/E	€ 118,00 x M*

6008/E + 604006 SX

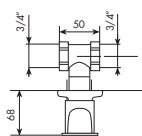

RUBINETTO D'ARRESTO 3/4"

> vitone ceramico 90°
> ingressi da 3/4"

 **605008**
p. 151

PARTI ESTERNE - CROMATO	
01-6008/E	€ 118,00
PARTE INCASSO	
604006	info pag. 41 € 65,00
PREZZO TOTALE	€ 183,00

PARTI ESTERNE - ALTRE FINITURE	
XX-6008/E	€ 118,00 x M*