

COLLEZIONI D'AUTORE



manifattura completamente italiana

LISTINO PREZZI / PRICE LIST 81.2017

CURA, ATTENZIONE, TECNICHE D'AVANGUARDIA, GUSTO, STILE ED ESPERIENZA, SONO GLI INGREDIENTI DELLE COLLEZIONI D'AUTORE BELLOSTA RUBINETTERIE

GRAZIE PER LA FIDUCIA

CARE, ATTENTION, AVANTGARDE TECHNIQUE, TASTE, STYLE AND EXPERIENCE ARE THE INGREDIENTS OF THE BELLOSTA RUBINETTERIE COLLECTIONS

THANKS FOR THE TRUST



rubinetti d'autore made in Italy

RIVENDITORE | AGENTE D'AREA

RETAILER | CONTACT AREA





N-JOY

DESIGN PIET BILLEKENS



TABELLA PREZZI FINITURE	pag. W-4
INFO TECNICHE	pag. W-4
INDICE / INDEX	pag. W-6
LAVABO	pag. W-10
BIDET	pag. W-13
DOCCIA INCASSO	pag. W-13
DEVIATORI INCASSO	pag. W-13
DOCCIA ESTERNO	pag. W-14
DOCCIA ESTERNO TERMOSTATICO	pag. W-15
VASCA	pag. W-15
BAGNO COMPLEMENTI	pag. W-17

PREZZO FINITURE

Calcola il prezzo di listino (IVA esclusa) delle finiture diverse dal cromato, consultando la seguente tabella.

Moltiplicare il **PREZZO LISTINO** per il **COEFFICIENTE MOLTIPLICATORE** della finitura scelta, arrotondando per difetto il prezzo ottenuto (eliminare i centesimi).
ESEMPIO per ordinare art. 0105 in finitura dorato, leva wengé: codice **04-0105-39**

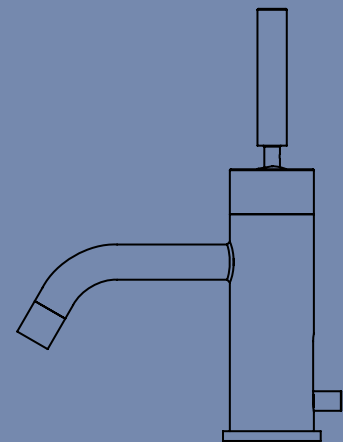
$$€ 259,00 \text{ (PREZZO LISTINO)} \times 2,15 \text{ (MOLTIPLICATORE)} = € \del{556,85} 556,00$$

PRICE FINISHES

Include the list price (excluding VAT) of different finishes from chrome, consulting the following table. Multiply the **PRICE LIST MULTIPLIER COEFFICIENT** of the chosen finish, reducing the price obtained by deleting the centesim.

EXAMPLE to order art. 0105 gold finish, wengé lever: code **04-0105-39**

$$€ 259,00 \text{ (LIST PRICE)} \times 2,15 \text{ (MULTIPLIER)} = € \del{556,85} 556,00$$

FINITURE DI SERIE / STANDARD FINISHES

CODICE CODE	DESCRIZIONE FINITURA FINISH DESCRIPTION	MOLTIPLICATORE MULTIPLIER
01-	cromato / chrome	PREZZO LISTINO*

FINITURE A RICHIESTA / ON REQUEST FINISHES

CODICE CODE	DESCRIZIONE FINITURA FINISH DESCRIPTION	MOLTIPLICATORE MULTIPLIER
02-	cromo/oro / chrome/gold	x 1,50
03-	oro/argento / gold/silver	x 1,65
04-	dorato / gold	x 2,15
05-	bronzo satinato / satin bronze	x 1,65
06-	rame vecchio / old copper	x 1,65
07-	vecchio argento / old silver	x 1,65
08-	canna di fucile / gun barrel	x 2,15
10-	verderame / verdigris	x 2,15
11-	nero antracite / anthracite black	x 2,15
12-	ottone lucido / polished brass	x 1,50
13-	ottone naturale / natural brass	x 1,30
14-	bianco / white	x 1,45
19-	nero / black	x 1,45
28-	nickel satinato / satin nickel	x 1,65
30-	nickel lucido / polished nickel	x 1,65

*PREZZO DI LISTINO / PRICE LIST

*NON REALIZZABILE / NOT MADE

ATTENZIONE! 13-OTTONE NATURALE e 88-OTTONE SISAL: finiture non protette che antichizzano naturalmente ossidando a contatto con l'umidità atmosferica.
WARNING! 13-NATURAL BRASS and 88-SISAL BRASS: unprotected finishes that naturally oxidise in contact with atmospheric humidity.

PROGETTO SU MISURA: RICHIESTE SPECIALI

I tecnici di Bellosta Rubinetterie sono, inoltre, a disposizione di architetti e designers, per offrire un servizio esclusivo: personalizzazioni di elementi in funzione di specifiche richieste estetiche o problematiche legate a vincoli progettuali, verifica della fattibilità attraverso opportuni studi CAD e sviluppo del disegno tecnico del prodotto speciale richiesto.

Per informazioni e richieste PROGETTI SU MISURA: ufficiotecnico@bellostarubinetterie.com



PROGETTO SU MISURA: SPECIAL REQUESTS

Engineers Bellosta Rubinetterie are also available to architects and designers, to offer an exclusive service: customizations of items according to specific aesthetic requirements or issues related to design constraints, verification of the feasibility studies and development through appropriate CAD technical design the required special product. For information and requests "SU MISURA" PROJECTS: ufficiotecnico@bellostarubinetterie.com

CONSIGLIO TECNICO

Tutti i miscelatori della collezione N-JOY vengono collaudati nel loro funzionamento al momento dell'assemblaggio. Per garantire la durata delle cartucce nel tempo, si consiglia di spurgare bene l'impianto idraulico prima del montaggio (per rimuovere eventuali detriti) e di installare rubinetti sottolavabo con filtro (art. 020 o 020/1)

N.B.: Qualora il piano lavabo avesse uno spessore superiore a 2,5 cm specificare la misura al momento dell'ordine.

COMPOSIZIONE CODICE PER ORDINARE ARTICOLO IN FINITURA



CODICE FINITURA FINISH CODE **CODICE ARTICOLO ITEM NUMBER** **CODICE FINITURA LEVA/INSERTO FINISH CODE LEVER/INSERT**

FINITURE A RICHIESTA / ON REQUEST FINISHES

CODICE CODE	DESCRIZIONE FINITURA FINISH DESCRIPTION	MOLTIPLICATORE MULTIPLIER
33-	cromo satinato / satin chrome	x 1,65
34-	cromo spazzolato / brushing chrome	x 1,70
35-	nickel spazzolato / brushing nickel	x 1,65
56-	avorio / ivory	x 1,65
57-	azzurro / light blue	x 1,65
58-	verdino / light green	x 1,65
59-	marrone / brown	x 1,65
60-	arancio / orange	x 1,65
61-	rosso / red	x 1,65
66-	bianco opaco / mat white	x 1,45
67-	nero opaco / mat black	x 1,45
68-	rame opaco / mat copper	x 1,65
69-	argento opaco / mat silver	x 1,65
71-	oro opaco / mat gold	x 2,15
72-	bronzo opaco / mat bronze	x 1,65
75-	dorato spazzolato / brushing gold	x 2,30
87-	oro rosa / pink gold	x 2,30
88-	ottone sisal / sisal brass	x 1,50

FORATURA DEI PIANI SANITARI

I miscelatori lavabo/bidet monoforo prevedono un foro di diametro 35 mm nel piano sanitario.

MONOFORO >>

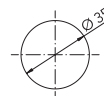

DRILLING PLANS HEALTH

The sink / hole bidet mixers provide a hole diameter of 35 mm in the health plan.

SCHEMA FUNZIONAMENTO DEVIATORI INCASSO 2/3/4 USCITE

Questi deviatori non hanno funzione di chiusura. Ruotando verso destra o sinistra si attivano le uscite. Tra 2 uscite adiacenti durante la rotazione diminuisce la portata dell'uscita iniziale ed incrementa quella della successiva. In posizione intermedia sono entrambe attive a pari portata.

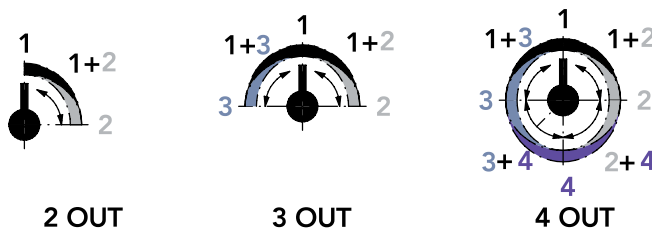

SCHEME OPERATION SWITCHES FLUSH OUTPUT 2/3/4

These diverters have not closing function. By turning to the right or left activates the outputs. Between two adjacent outputs during the rotation decreases the initial output flow and increases that of the next. In position intermediate are both active at the same flow rate.

LE LEVE - I COLORI:

A - Leva stilo lunga 81 mm

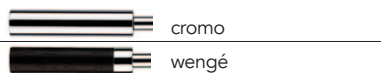

LEVERS - COLOURS:

B - Leva stilo corta 66 mm

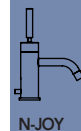
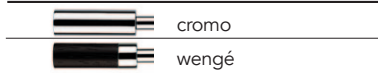

LAVABO



01-0105-01 pag. W-10

01-0105-39 pag. W-10

MISCELATORE LAVABO MONOFORO
BASIN MIXER



01-0105/S-01 pag. W-10

01-0105/S-39 pag. W-10

MISCELATORE LAVABO MONOFORO
BASIN MIXER



01-0105/P-01 pag. W-10

01-0105/P-39 pag. W-10

MISCELATORE LAVABO MONOFORO
BOCCA PROLUNGATA
BASIN MIXER EXTENDED SPOUT



01-0105/P/S-01 pag. W-10

01-0105/P/S-39 pag. W-10

MISCELATORE LAVABO MONOFORO
BOCCA PROLUNGATA
BASIN MIXER EXTENDED SPOUT



01-0105/P/A-01 pag. W-10

01-0105/P/A-39 pag. W-10

MISCELATORE LAVABO MONOFORO
BOCCA EXTRAPROLUNGATA
BASIN MIXER EXTRA EXTENDED SPOUT



01-0105/P/A/S-01 pag. W-11

01-0105/P/A/S-39 pag. W-11

MISCELATORE LAVABO MONOFORO
BOCCA EXTRAPROLUNGATA
BASIN MIXER EXTRA EXTENDED SPOUT



044026, 044027, 044028 pag. W-11

PROLUNGHE MISCELATORE LAVABO pag. W-11
EXTENSIONS FOR BASIN

altezza mm 50 / high 50 mm: 044026
altezza mm 100 / high 100 mm: 044027
altezza mm 150 / high 150 mm: 044028



01-0105/3/A/E-01 + 104033 pag. W-11

01-0105/3/A/E-39 + 104033 pag. W-11

MISCELATORE LAVABO DA PARETE
WALL BASIN MIXER

parti esterne / external parts: 0105/3/A/E
parte incasso / built-in part: 104033



01-0105/3/B/E-01 + 104033 pag. W-11

01-0105/3/B/E-39 + 104033 pag. W-11

MISCELATORE LAVABO DA PARETE
BOCCA PROLUNGATA
WALL BASIN MIXER EXTENDED SPOUT

parti esterne / external parts: 0105/3/B/E
parte incasso / built-in part: 104033



0105/3/C/E-01 + 104033 pag. W-11

0105/3/C/E-39 + 104033 pag. W-11

MISCELATORE LAVABO DA PARETE
BOCCA EXTRAPROLUNGATA
WALL BASIN MIXER EXTRA EXTENDED SPOUT

parti esterne / external parts: 0105/3/C/E
parte incasso / built-in part: 104033



01-0105/R/A-01 pag. W-12

01-0105/R/A-39 pag. W-12

MISCELATORE REMOTO
REMOTE MIXER



01-0105/R/B/E-01 + 104033 pag. W-12

01-0105/R/B/E-39 + 104033 pag. W-12

MISCELATORE INCASSO REMOTO
BUILT-IN REMOTE MIXER

parti esterne / external parts: 0105/R/B/E
parte incasso / built-in part: 104033



01-0405/1/A pag. W-12

BOCCA LAVABO
WASH SPOUT



01-0405/1/B pag. W-12

BOCCA LAVABO MEDIUM
"MEDIUM" WASH SPOUT



01-0405/1/C pag. W-12

BOCCA LAVABO ALTA
HIGH WASH SPOUT



01-0405/26 pag. W-13

BOCCA LAVABO CON ATTACCO A PAVIMENTO
WASH SPOUT FLOOR CONNECTION

BIDET



01-0107-01 pag. W-13
 01-0107-39 pag. W-13
 MISCELATORE BIDET MONOFORO
 BIDET MIXER

DOCCIA INCASSO



01-0121/N/E-01 + 104018 pag. W-13
 01-0121/N/E-39 + 104018 pag. W-13
 MISCELATORE INCASSO
 BUILT-IN MIXER
 parti esterne / external parts: 0121/N/E
 parte incasso / built-in part: 104018



01-0100/E-01 + 104002 pag. W-13
 01-0100/E-39 + 104002 pag. W-13
 MISCELATORE INCASSO C/DEVIATORE
 2 USCITE
 BUILT-IN MIXER WITH DIVERTER 2 OUT
 parti esterne / external parts: 0100/E
 parte incasso / built-in part: 104002

DEVIATORI INCASSO



01-0103/2/1N/E-01 + 914016 pag. W-13
 01-0103/2/1N/E-39 + 914016 pag. W-13
 DEVIATORE INCASSO 2 USCITE
 BUILT-IN DIVERTER 2 OUT
 parti esterne / external parts: 0103/2/1N/E
 parte incasso / built-in part: 914016



01-0103/3/1N/E-01 + 034127 pag. W-14
 01-0103/3/1N/E-39 + 034127 pag. W-14
 DEVIATORE INCASSO 3 USCITE
 BUILT-IN DIVERTER 3 OUT
 parti esterne / external parts: 0103/3/1N/E
 parte incasso / built-in part: 034127



01-0103/4/1N/E-01 + 034128 pag. W-14
 01-0103/4/1N/E-39 + 034128 pag. W-14
 DEVIATORE INCASSO 4 USCITE
 BUILT-IN DIVERTER 4 OUT
 parti esterne / external parts: 0103/4/1N/E
 parte incasso / built-in part: 034128

DOCCIA INCASSO TERMOSTATICO



8812/H/P/E + 484020 pag. 192*
 MISCELATORE TERMOSTATICO INCASSO 1 USCITA
 BUILT-IN THERMOSTATIC MIXER 1 OUT
 parti esterne / external parts: 8812/H/P/E
 parte incasso / built-in part: 484020



8812/2/P/E + 484021 pag. 192*
 MISCELATORE TERMOSTATICO INCASSO
 C/DEVIATORE 2 USCITE
 BUILT-IN THERMOSTATIC MIXER WITH DIVERTER
 2 OUT
 parti esterne / external parts: 8812/2/P/E
 parte incasso / built-in part: 484021



8812/3/P/E + 484022 pag. 192*
 MISCELATORE TERMOSTATICO INCASSO
 C/DEVIATORE 3 USCITE
 BUILT-IN THERMOSTATIC MIXER WITH DIVERTER
 3 OUT
 parti esterne / external parts: 8812/3/P/E
 parte incasso / built-in part: 484022



8812/4/P/E + 484023 pag. 192*
 MISCELATORE TERMOSTATICO INCASSO
 C/DEVIATORE 4 USCITE
 BUILT-IN THERMOSTATIC MIXER WITH DIVERTER
 4 OUT
 parti esterne / external parts: 8812/4/P/E
 parte incasso / built-in part: 484023

DOCCIA ESTERNO



01-0109/1-01 pag. W-14
 01-0109/1-39 pag. W-14
 MISCELATORE DOCCIA ESTERNO
 EXTERNAL SHOWER MIXER



01-0109/4/SP-01 pag. W-14
 01-0109/4/SP-39 pag. W-14
 MISCELATORE DOCCIA ESTERNO C/STELO
 EXTERNAL SHOWER MIXER WITH PIPE



01-0109/5/1/SP-01 pag. W-15
 01-0109/5/1/SP-39 pag. W-15
 MISCELATORE DOCCIA ESTERNO C/STELO
 COMPLETO
 EXTERNAL SHOWER MIXER WITH PIPE

* ABBINAMENTO CONSIGLIATO: PER PREZZI E SCHEDE TECNICHE, VEDI RIFERIMENTO PAGINA LISTINO REVIVRE
 * RECOMMENDED COMBINATION: FOR PRICES AND TECHNICAL DETAILS, LOOK AT PAGE WITH REFERENCE REVIVRE PRICE

DOCCIA ESTERNO TERMOSTATICO



01-0111/1A-01	pag. W-15
01-0111/1A-39	pag. W-15

MISCELATORE DOCCIA ESTERNO TERMOSTATICO
EXTERNAL THERMOSTATIC MIXER



01-0111/4A-01	pag. W-15
01-0111/4A-39	pag. W-15

MISCELATORE DOCCIA ESTERNO TERMOSTATICO C/STELO
EXTERNAL THERMOSTATIC MIXER WITH PIPE



01-0111/5A-01	pag. W-15
01-0111/5A-39	pag. W-15

MISCELATORE DOCCIA ESTERNO TERMOSTATICO C/STELO COMPLETO
EXTERNAL THERMOSTATIC MIXER WITH COMPLETE PIPE

DOCCIA COMPLEMENTI



4403/1/A	pag. 134*
----------	-----------

SUPPORTO DOCCIA COMPLETO
FULL SHOWER SUPPORT



4403/1	pag. 135*
--------	-----------

SUPPORTO DOCCIA DUPLEX COMPLETO
FULL SHOWER SUPPORT WITH DUPLEX



0403/1/C	pag. 132*
----------	-----------

SUPPORTO DOCCIA COMPLETO
FULL SHOWER SUPPORT



0403/1/B	pag. 132*
----------	-----------

SUPPORTO DOCCIA DUPLEX COMPLETO
FULL SHOWER SUPPORT WITH DUPLEX



0530	pag. 140*
------	-----------

SALISCENDI COMPLETO C/PRESA D'ACQUA
COMPLETE WALL PIPE WITH WATER CONNECTION



0530/1	pag. 145*
--------	-----------

ASTA SALISCENDI
WALL PIPE



0413/4/SP	pag. 149*
-----------	-----------

CURVA PRESA ACQUA C/STELO COMPLETO
CURVE WATER CONNECTOR WITH COMPLETE ROD



0413/5/1/SP	pag. 150*
-------------	-----------

CURVA PRESA ACQUA C/STELO COMPLETO
CURVE WATER CONNECTOR WITH COMPLETE ROD



0514	pag. 153*
------	-----------

CESTINO PORTASAPONE
SOAP BASKET

VASCA



01-0101/A-01	pag. W-15
01-0101/A-39	pag. W-15

MISCELATORE VASCA ESTERNO
EXTERNAL BATH MIXER



01-0101/2/A-01	pag. W-16
01-0101/2/A-39	pag. W-16

MISCELATORE PER BORDO VASCA
BATH RIM MIXER

VASCA



01-0101/2/P/A-01 pag. W-16

01-0101/2/P/A-39 pag. W-16

MISCELATORE PER BORDO VASCA
C/PIASTRA
BATH RIM MIXER ON PLATE



01-0101/20/A-01 pag. W-16

01-0101/20/A-39 pag. W-16

MISCELATORE PER BORDO VASCA
S/BOCCA
BATH RIM MIXER WITHOUT SPOUT



01-0101/20/P/A-01 pag. W-16

01-0101/20/P/A-39 pag. W-16

MISCELATORE PER BORDO VASCA
C/PIASTRA S/BOCCA
BATH RIM MIXER WITHOUT SPOUT ON PLATE



01-0103 pag. W-16

BOCCA VASCA DA PARETE
WALL BATH SPOUT



01-0401/26 pag. W-17

BOCCA VASCA DA PAVIMENTO
BATH SPOUT FLOOR CONNECTION

BAGNO COMPLEMENTI



01-0108/E-01 + 054025 o 054026 pag. W-17

01-0108/E-39 + 054025 o 054026 pag. W-17

RUBINETTO D'ARRESTO 1/2"
BUILT-IN STOP COCK 1/2"

parti esterne / external parts: 0108/E
parte incasso / built-in part: 054025 DX o 054026 SX



01-0108/E-01 + 054027 o 054028 pag. W-17

01-0108/E-39 + 054027 o 054028 pag. W-17

RUBINETTO D'ARRESTO 3/4"
BUILT-IN STOP COCK 3/4"

parti esterne / external parts: 0108/E
parte incasso / built-in part: 054027 DX o 054028 SX



01-0140/E-01 + 884053 pag. W-17

01-0140/E-39 + 884053 pag. W-17

PASSO RAPIDO 3/4"
BUILT-IN RAPID FLOW COCK 3/4"

parti esterne / external parts: 0140/E
parte incasso / built-in part: 884053



01-0140/E-01 + 884054 pag. W-17

01-0140/E-39 + 884054 pag. W-17

PASSO RAPIDO 1"
BUILT-IN RAPID FLOW COCK 1"

parti esterne / external parts: 0140/E
parte incasso / built-in part: 884054



01-0132/2/E-01 + 035212 pag. W-18

01-0132/2/E-39 + 035212 pag. W-18

SARACINESCA
GATE VALVE

parti esterne / external parts: 0132/2/E
parte incasso / built-in part: 035212



0105

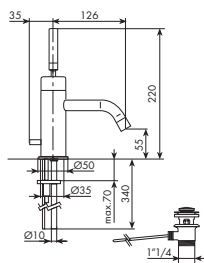

MISCELATORE LAVABO MONOFORO

- > cartuccia joystick
- > interasse bocca 126
- > flessibili di alimentazione
- > con scarico

 015008
p. 149

 014073
p. 140

CROMATO

01-0105-01	€ 259,00
01-0105-39	€ 259,00

ALTRE FINITURE

XX-0105-XX	€ 259,00 x M*
XX-0105-39	€ 259,00 x M*

0105/S

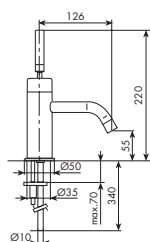

MISCELATORE LAVABO MONOFORO

- > cartuccia joystick
- > interasse bocca 126
- > flessibili di alimentazione
- > senza scarico

 015008
p. 149

 014073
p. 140

CROMATO

01-0105/S-01	€ 244,00
01-0105/S-39	€ 244,00

ALTRE FINITURE

XX-0105/S-XX	€ 244,00 x M*
XX-0105/S-39	€ 244,00 x M*

0105/P

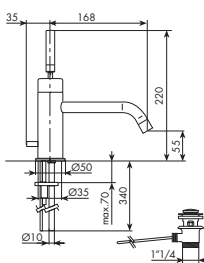
MISCELATORE LAVABO MONOFORO BOCCA
PROLUNGATA

- > cartuccia joystick
- > interasse bocca 168
- > flessibili di alimentazione
- > con scarico

 015008
p. 149

 014073
p. 140

CROMATO

01-0105/P-01	€ 278,00
01-0105/P-39	€ 278,00

ALTRE FINITURE

XX-0105/P-XX	€ 278,00 x M*
XX-0105/P-39	€ 278,00 x M*

0105/P/S

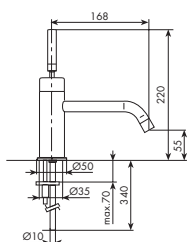
MISCELATORE LAVABO MONOFORO BOCCA
PROLUNGATA

- > cartuccia joystick
- > interasse bocca 168
- > flessibili di alimentazione
- > senza scarico

 015008
p. 149

 014073
p. 140

CROMATO

01-0105/P/S-01	€ 258,00
01-0105/P/S-39	€ 258,00

ALTRE FINITURE

XX-0105/P/S-XX	€ 258,00 x M*
XX-0105/P/S-39	€ 258,00 x M*

0105/P/A

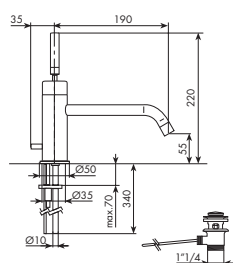
MISCELATORE LAVABO MONOFORO BOCCA
EXTRAPROLUNGATA

- > cartuccia joystick
- > interasse bocca 190
- > flessibili di alimentazione
- > con scarico

 015008
p. 149

 014073
p. 140

CROMATO

01-0105/P/A-01	€ 293,00
01-0105/P/A-39	€ 293,00

ALTRE FINITURE

XX-0105/P/A-XX	€ 293,00 x M*
XX-0105/P/A-39	€ 293,00 x M*

0105/P/A/S

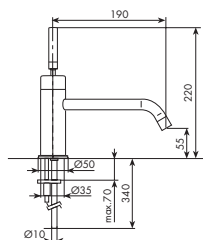
MISCELATORE LAVABO MONOFORO BOCCA
EXTRAPROLUNGATA

- > cartuccia joystick
- > interasse bocca 190
- > flessibili di alimentazione
- > senza scarico



CROMATO

01-0105/P/A/S-01	€ 274,00
01-0105/P/A/S-39	€ 274,00

ALTRE FINITURE

XX-0105/P/A/S-XX	€ 274,00 x M*
XX-0105/P/A/S-39	€ 274,00 x M*

044026 | 044027 | 044028



PROLUNGHE MISCELATORE LAVABO

- > diametro Ø 43 mm
- > altezza 50 mm, 100 mm, 150 mm

CROMATO

01-044026	50 mm	€ 58,00
01-044027	100 mm	€ 95,00
01-044028	150 mm	€ 120,00

ALTRE FINITURE

XX-044026	50 mm	€ 58,00 x M*
XX-044027	100 mm	€ 95,00 x M*
XX-044028	150 mm	€ 120,00 x M*

0105/3/A/E + 104033

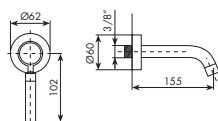

MISCELATORE LAVABO DA PARETE

- > cartuccia tradizionale
- > interasse bocca 155
- > ingressi da 1/2"
- > rosoni separati
- > senza scarico



PARTI ESTERNE - CROMATO

01-0105/3/A/E-01	€ 164,00
01-0105/3/A/E-39	€ 164,00

PARTI ESTERNE - ALTRE FINITURE

XX-0105/3/A/E-XX	€ 164,00 x M*
XX-0105/3/A/E-39	€ 164,00 x M*

PARTE INCASSO

01-104033	info pag. 32	€ 109,00
-----------	--------------	----------

PREZZO TOTALE € 273,00

0105/3/B/E + 104033

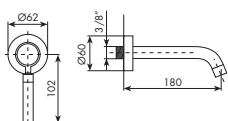

MISCELATORE LAVABO DA PARETE BOCCA

- > cartuccia tradizionale
- > interasse bocca 180
- > ingressi da 1/2"
- > rosoni separati
- > senza scarico



PARTI ESTERNE - CROMATO

01-0105/3/B/E-01	€ 177,00
01-0105/3/B/E-39	€ 177,00

PARTI ESTERNE - ALTRE FINITURE

XX-0105/3/B/E-XX	€ 177,00 x M*
XX-0105/3/B/E-39	€ 177,00 x M*

PARTE INCASSO

01-104033	info pag. 32	€ 109,00
-----------	--------------	----------

PREZZO TOTALE € 286,00

0105/3/C/E + 104033

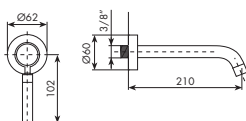

MISCELATORE LAVABO DA PARETE BOCCA

- > cartuccia tradizionale
- > interasse bocca 210
- > ingressi da 1/2"
- > rosoni separati
- > senza scarico



PARTI ESTERNE - CROMATO

01-0105/3/C/E-01	€ 194,00
01-0105/3/C/E-39	€ 194,00

PARTI ESTERNE - ALTRE FINITURE

XX-0105/3/C/E-XX	€ 194,00 x M*
XX-0105/3/C/E-39	€ 194,00 x M*

PARTE INCASSO

01-104033	info pag. 32	€ 109,00
-----------	--------------	----------

PREZZO TOTALE € 303,00

ACCESSORI



RICAMBI IMMEDIATI



XX = CODICE FINITURA RICHIESTA: per identificare codice corretto vedi pag. W-4
 M* = MOLTIPLICATORE: per calcolare il prezzo delle altre finiture vedi tabella pag. W-4

0105/R/A

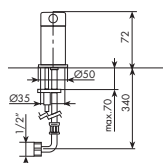

MISCELATORE REMOTO

- > cartuccia tradizionale
- > flessibili di alimentazione
- > senza scarico

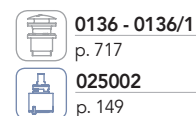

CROMATO

01-0105/R/A-01	€ 183,00
01-0105/R/A-39	€ 183,00

ALTRE FINITURE

XX-0105/R/A-XX	€ 183,00 x M*
XX-0105/R/A-39	€ 183,00 x M*

0105/R/B/E + 104033

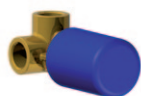
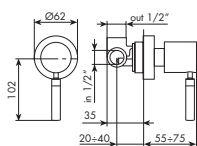

MISCELATORE INCASSO REMOTO

- > cartuccia tradizionale
- > ingressi da 1/2"
- > uscita superiore
- > rosone tondo
- > senza scarico

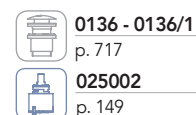

PARTI ESTERNE - CROMATO

01-0105/R/B/E-01	€ 104,00
01-0105/R/B/E-39	€ 104,00

PARTI ESTERNE - ALTRE FINITURE

XX-0105/R/B/E-XX	€ 104,00 x M*
XX-0105/R/B/E-39	€ 104,00 x M*

PARTE INCASSO

01-104033	info pag. 32	€ 109,00
-----------	--------------	----------

PREZZO TOTALE	€ 213,00
---------------	----------

0405/1/A

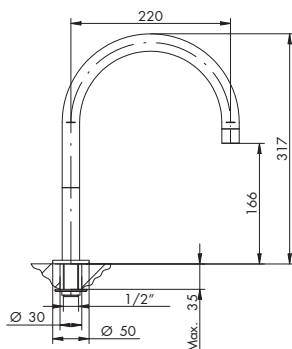

BOCCA LAVABO

- > ingresso da 1/2"
- > interasse 220
- > altezza d'erogazione 166
- > senza scarico



CROMATO

01-0405/1/A	€ 248,00
-------------	----------

ALTRE FINITURE

XX-0405/1/A	€ 248,00 x M*
-------------	---------------

0405/1/B

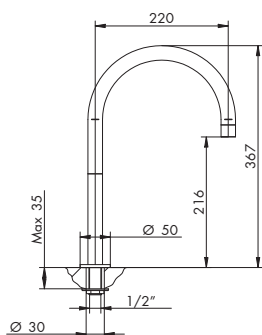

BOCCA LAVABO MEDIUM

- > ingresso da 1/2"
- > interasse 220
- > altezza d'erogazione 216
- > senza scarico



CROMATO

01-0405/1/B	€ 272,00
-------------	----------

ALTRE FINITURE

XX-0405/1/B	€ 272,00 x M*
-------------	---------------

0405/1/C

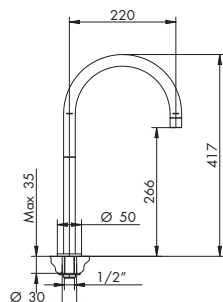

BOCCA LAVABO ALTA

- > ingresso da 1/2"
- > interasse 220
- > altezza d'erogazione 266
- > senza scarico

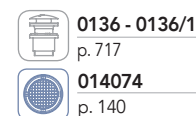

CROMATO

01-0405/1/C	€ 296,00
-------------	----------

ALTRE FINITURE

XX-0405/1/C	€ 296,00 x M*
-------------	---------------

0405/26

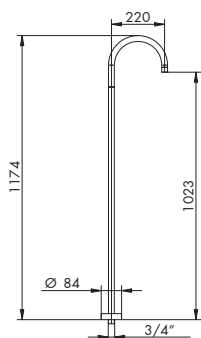

BOCCA LAVABO CON ATTACCO A PAVIMENTO

- > ingresso da 3/4"
- > interasse bocca 220
- > altezza d'erogazione 1023
- > senza scarico

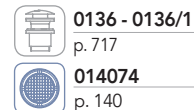

CROMATO	
01-0405/26	€ 575,00

ALTRE FINITURE	
XX-0405/26	€ 575,00 x M*

0107

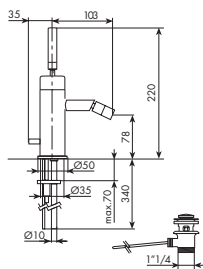

MISCELATORE BIDET MONOFORO

- > cartuccia joystick
- > interasse bocca 103
- > aeratore snodato
- > flessibili di alimentazione
- > con scarico



CROMATO	
01-0107-01	€ 259,00
01-0107-39	€ 259,00

ALTRE FINITURE	
XX-0107-XX	€ 259,00 x M*
XX-0107-39	€ 259,00 x M*

0121/N/E + 104018

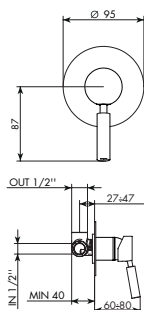

MISCELATORE INCASSO

- > cartuccia tradizionale
- > attacchi da 1/2"
- > uscita superiore
- > incasso con B-Box

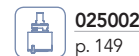

PARTI ESTERNE - CROMATO	
01-0121/N/E-01	€ 116,00
01-0121/N/E-39	€ 116,00

PARTI ESTERNE - ALTRE FINITURE	
XX-0121/N/E-XX	€ 116,00 x M*
XX-0121/N/E-39	€ 116,00 x M*

PARTE INCASSO	
01-104018 info pag. 36	€ 109,00
PREZZO TOTALE	€ 225,00

0100/E + 104002

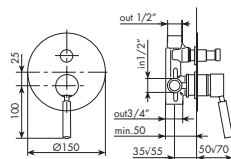

MISCELATORE INCASSO C/DEVIATORE

- 2 USCITE
- > cartuccia tradizionale
- > deviatore a pressione 2 uscite c/ritorno automatico e blocco meccanico basse pressioni
- > attacchi da 1/2"
- > uscita principale inferiore da 3/4"
- > Incasso con B-Box

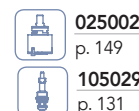

PARTI ESTERNE - CROMATO	
01-0100/E-01	€ 126,00
01-0100/E-39	€ 126,00

PARTI ESTERNE - ALTRE FINITURE	
XX-0100/E-XX	€ 126,00 x M*
XX-0100/E-39	€ 126,00 x M*

PARTE INCASSO	
01-104002 info pag. 37	€ 223,00
PREZZO TOTALE	€ 349,00

0103/2/1N/E + 914016

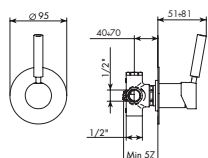

DEVIATORE INCASSO 2 USCITE

- > deviatore a dischi ceramici 2 uscite senza chiusura
- > attacchi da 1/2"

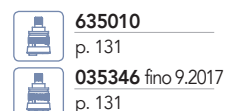

PARTI ESTERNE - CROMATO	
01-0103/2/1N/E-01	€ 127,00
01-0103/2/1N/E-39	€ 127,00

PARTI ESTERNE - ALTRE FINITURE	
XX-0103/2/1N/E-XX	€ 127,00 x M*
XX-0103/2/1N/E-39	€ 127,00 x M*

PARTE INCASSO	
914016 info pag. 38	€ 82,00
PREZZO TOTALE	€ 209,00

ACCESSORI



SCARICO C/TAPPO A PRESSIONE

RICAMBI IMMEDIATI



CARTUCCIA



CARTUCCIA DEVIATRICE



DEVIATORE

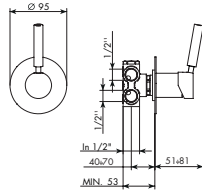

XX = CODICE FINITURA RICHIESTA: per identificare codice corretto vedi pag. W-4
 M* = MULTIPLICATORE: per calcolare il prezzo delle altre finiture vedi tabella pag. W-4

0103/3/1N/E + 034127



DEVIATORE INCASSO 3 USCITE

> deviatore a dischi ceramici 3 uscite senza chiusura
> attacchi da 1/2"

 **635011**
p. 131
 **035345** fino 9.2017
p. 131

PARTI ESTERNE - CROMATO

01-0103/3/1N/E-01	€ 133,00
01-0103/3/1N/E-39	€ 133,00

PARTI ESTERNE - ALTRE FINITURE

XX-0103/3/1N/E-XX	€ 133,00 x M*
XX-0103/3/1N/E-39	€ 133,00 x M*

PORTE INCASSO

034127	info pag. 38	€ 114,00
--------	--------------	----------

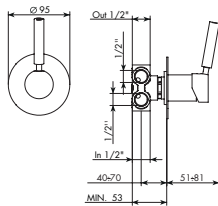

PREZZO TOTALE	€ 247,00
----------------------	-----------------

0103/4/1N/E + 034128



DEVIATORE INCASSO 4 USCITE

> deviatore a dischi ceramici 4 uscite senza chiusura
> attacchi da 1/2"

 **635012**
p. 131
 **035344** fino 9.2017
p. 131

PARTI ESTERNE - CROMATO

01-0103/4/1N/E-01	€ 146,00
01-0103/4/1N/E-39	€ 146,00

PARTI ESTERNE - ALTRE FINITURE

XX-0103/4/1N/E-XX	€ 146,00 x M*
XX-0103/4/1N/E-39	€ 146,00 x M*

PORTE INCASSO

034128	info pag. 38	€ 126,00
--------	--------------	----------

PREZZO TOTALE	€ 272,00
----------------------	-----------------

I DOCCIA INCASSO TERMOSTATICO CONSIGLIATI SONO PRESENTI SU LISTINO REVIVRE

- 8812/H/P/E + 484020
- 8812/2/P/E + 484021
- 8812/3/P/E + 484022
- 8812/4/P/E + 484023

I DOCCIA COMPLEMENTI CONSIGLIATI SONO PRESENTI SU LISTINO REVIVRE

- | | | |
|----------|-------------|------|
| 4403/1/A | 0530 | 0514 |
| 4403/1 | 0530/1 | |
| 0403/1/C | 0413/4/SP | |
| 0403/1/B | 0413/5/1/SP | |

0109/1

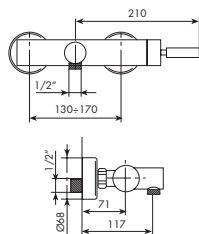

MISCELATORE DOCCIA ESTERNO

> cartuccia joystick
> senza set doccia
> attacchi da 1/2"

 **015008**
p. 149

CROMATO

01-0109/1-01	€ 385,00
01-0109/1-39	€ 385,00

ALTRE FINITURE

XX-0109/1-XX	€ 385,00 x M*
XX-0109/1-39	€ 385,00 x M*

0109/4/SP

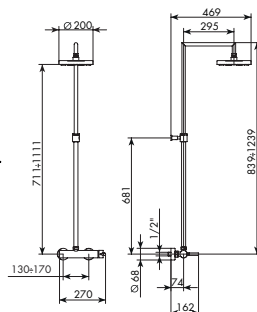

MISCELATORE DOCCIA ESTERNO C/STELO

> cartuccia tradizionale
> stelo regolabile
> soffione orientabile Ø200 in ABS con anticalcare, per finiture diverse da cromo soffione in metallo
> attacchi da 1/2"

 **025002**
p. 149

CROMATO

01-0109/4/SP-01	€ 971,00
01-0109/4/SP-39	€ 971,00

ALTRE FINITURE

XX-0109/4/SP-XX	€ 971,00 x M*
XX-0109/4/SP-39	€ 971,00 x M*

0109/5/1/SP

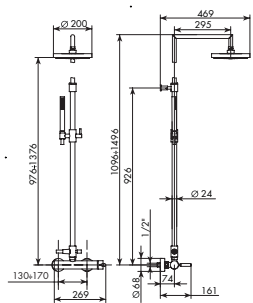

MISCELATORE DOCCIA ESTERNO C/STELO COMPLETO

- > cartuccia tradizionale
- > stelo regolabile
- > deviatore a trazione c/ritorno automatico e blocco meccanico bassa pressione
- > soffione orientabile Ø200 in ABS c/anticalcare
- > flessibile in PVC 150 cm
- > supporto doccetta scorrevole
- > doccetta monogetto cilindrica in ABS c/anticalcare, per finiture diverse da cromo doccetta e soffione in metallo

025002

p. 149

045073

p. 131

CROMATO

01-0109/5/1/SP-01 € 1.326,00

01-0109/5/1/SP-39 € 1.326,00

ALTRE FINITURE

XX-0109/5/1/SP-XX € 1.326,00 x M*

XX-0109/5/1/SP-39 € 1.326,00 x M*

0111/1A

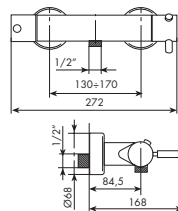

MISCELATORE DOCCIA ESTERNO TERMOSTATICO

- > cartuccia termostatica
- > vitone ceramico 90°
- > senza set doccia
- > attacchi da 1/2"

885041

p. 150

055002

p. 151

CROMATO

01-0111/1A-01 € 514,00

01-0111/1A-39 € 514,00

ALTRE FINITURE

XX-0111/1A-XX € 514,00 x M*

XX-0111/1A-39 € 514,00 x M*

0111/4A

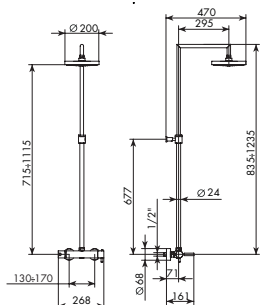

MISCELATORE DOCCIA ESTERNO TERMOSTATICO C/STELO

- > cartuccia termostatica
- > stelo regolabile
- > soffione orientabile Ø200 in ABS con anticalcare, per finiture diverse da cromo soffione in metallo
- > attacchi da 1/2"

885041

p. 150

055002

p. 151

CROMATO

01-0111/4A-01 € 1.145,00

01-0111/4A-39 € 1.145,00

ALTRE FINITURE

XX-0111/4A-XX € 1.145,00 x M*

XX-0111/4A-39 € 1.145,00 x M*

0111/5A

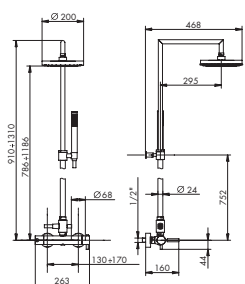
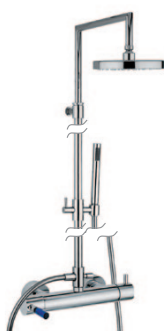

MISCELATORE DOCCIA ESTERNO TERMOSTATICO C/STELO COMPLETO

- > cartuccia termostatica
- > stelo regolabile
- > deviatore a trazione c/ritorno automatico e blocco meccanico bassa pressione
- > soffione orientabile Ø200 c/anticalcare
- > supporto doccetta scorrevole
- > doccetta monogetto cilindrica in ABS c/anticalcare, per finiture diverse da cromo doccetta e soffione in metallo
- > flessibile in PVC 150 cm
- > attacchi da 1/2"

885041

p. 150

055002

p. 151

045073

p. 131

CROMATO

01-0111/5A-01 € 1.470,00

01-0111/5A-39 € 1.470,00

ALTRE FINITURE

XX-0111/5A-XX € 1.470,00 x M*

XX-0111/5A-39 € 1.470,00 x M*

0101/A

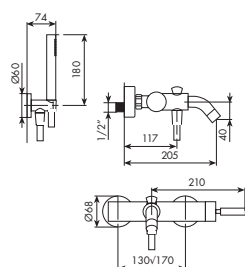

MISCELATORE VASCA ESTERNO

- > cartuccia joystick
- > interasse bocca 205
- > deviatore a trazione c/ritorno automatico e blocco meccanico per basse pressioni
- > flessibile in PVC 150 cm
- > supporto a parete fisso
- > attacchi da 1/2"
- > doccetta monogetto cilindrica in ABS c/anticalcare, per finiture diverse da cromo doccetta in metallo

015008

p. 149

014072

p. 130

014074

p. 140

CROMATO

01-0101/A-01 € 529,00

01-0101/A-39 € 529,00

ALTRE FINITURE

XX-0101/A-XX € 529,00 x M*

XX-0101/A-39 € 529,00 x M*

RICAMBI IMMEDIATI



XX = CODICE FINITURA RICHIESTA: per identificare codice corretto vedi pag. W-4
 M* = MOLTIPLICATORE: per calcolare il prezzo delle altre finiture vedi tabella pag. W-4

0101/2/A

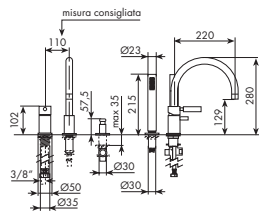

MISCELATORE PER BORDO VASCA

- > cartuccia tradizionale
- > interasse bocca 220 > bocca girevole 360°
- > deviatore a pressione c/ritorno automatico e blocco meccanico per basse pressioni
- > flessibile in PVC 150 cm > flessibili di alimentazione
- > senza scarico
- > doccetta monogetto cilindrica in ABS c/anticalcare, per finiture diverse da cromo doccetta in metallo
- > PREDISPOSIZIONI per bordo vasca, art. 012/4, 012/6 e 012/7, vedi pag. 615

	025002	p. 149
	724030	p. 132
	014074	p. 140

CROMATO		ALTRE FINITURE	
01-0101/2/A-01	€ 720,00	XX-0101/2/A-XX	€ 720,00 x M*
01-0101/2/A-39	€ 720,00	XX-0101/2/A-39	€ 720,00 x M*

0101/2/P/A

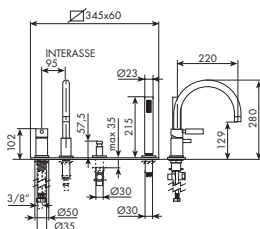

MISCELATORE PER BORDO VASCA C/PIASTRA

- > cartuccia tradizionale
- > interasse bocca 220 > bocca girevole 360°
- > deviatore a pressione c/ritorno automatico e blocco meccanico per basse pressioni
- > flessibile in PVC 150 cm > flessibili di alimentazione
- > senza scarico
- > piastra estetica interasse fori 95mm
- > doccetta monogetto cilindrica in ABS c/anticalcare, per finiture diverse da cromo doccetta in metallo

	025002	p. 149
	724030	p. 132
	014074	p. 140

CROMATO		ALTRE FINITURE	
01-0101/2/P/A-01	€ 812,00	XX-0101/2/P/A-XX	€ 812,00 x M*
01-0101/2/P/A-39	€ 812,00	XX-0101/2/P/A-39	€ 812,00 x M*

0101/20/A

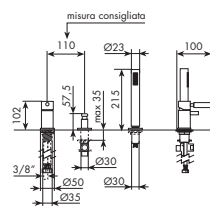

MISCELATORE PER BORDO VASCA S/BOCCA

- > cartuccia tradizionale
- > senza bocca
- > deviatore a pressione c/ritorno automatico e blocco meccanico per basse pressioni
- > flessibile in PVC 150 cm > flessibili di alimentazione
- > senza scarico
- > doccetta monogetto cilindrica in ABS c/anticalcare, per finiture diverse da cromo doccetta in metallo
- > PREDISPOSIZIONI per bordo vasca, art. 012/3, 012/6 e 012/7, vedi pag. 615

	025002	p. 149
	724030	p. 132

CROMATO		ALTRE FINITURE	
01-0101/20/A-01	€ 573,00	XX-0101/20/A-XX	€ 573,00 x M*
01-0101/20/A-39	€ 573,00	XX-0101/20/A-39	€ 573,00 x M*

0101/20/P/A

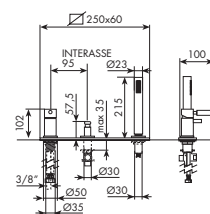

MISCELATORE PER BORDO VASCA C/PIASTRA S/BOCCA

- > cartuccia tradizionale
- > senza bocca
- > deviatore a pressione c/ritorno automatico e blocco meccanico per basse pressioni
- > flessibile in PVC 150 cm > flessibili di alimentazione
- > senza scarico
- > piastra estetica interasse fori 95mm
- > doccetta monogetto cilindrica in ABS c/anticalcare, per finiture diverse da cromo doccetta in metallo

	025002	p. 149
	724030	p. 132

CROMATO		ALTRE FINITURE	
01-0101/20/P/A-01	€ 661,00	XX-0101/20/P/A-XX	€ 661,00 x M*
01-0101/20/P/A-39	€ 661,00	XX-0101/20/P/A-39	€ 661,00 x M*

0103

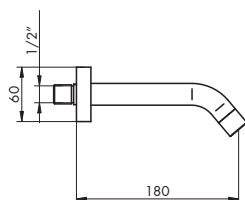

BOCCA VASCA DA PARETE

- > interasse bocca 180
- > attacco da 3/4"

	014074	p. 140
--	---------------	--------

CROMATO		ALTRE FINITURE	
01-0103	€ 82,00	XX-0103	€ 82,00 x M*

0401/26

BOCCA VASCA DA PAVIMENTO

> interasse bocca 250
> attacco da 3/4"

 014075
p. 140

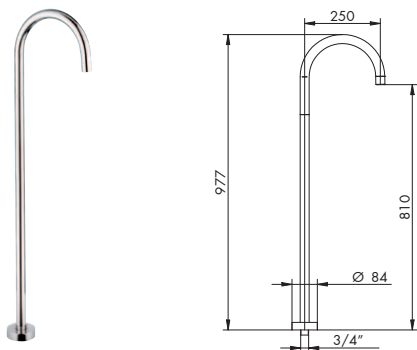

CROMATO	
01-0401/26	€ 637,00

ALTRE FINITURE	
XX-0401/26	€ 637,00 x M*

0108/E+ 054025 DX o 054026 SX

RUBINETTO D'ARRESTO 1/2"

> vitone ceramico 90°
> ingressi da 1/2"

 055001
p. 151

 055002
p. 151

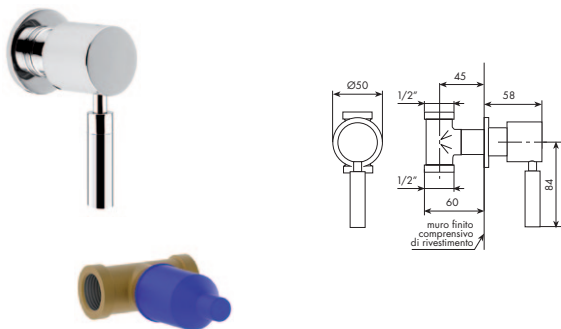

PARTI ESTERNE - CROMATO	
01-0108/E-01	€ 127,00
01-0108/E-39	€ 127,00

PARTI ESTERNE - ALTRE FINITURE	
XX-0108/E-XX	€ 127,00 x M*
XX-0108/E-39	€ 127,00 x M*

PARTE INCASSO	
054025 o 054026 info pag. 40	€ 44,00
PREZZO TOTALE	€ 171,00

0108/E + 054027 DX o 054028 SX

RUBINETTO D'ARRESTO 3/4"

> vitone ceramico 90°
> ingressi da 3/4"

 055001
p. 151

 055002
p. 151

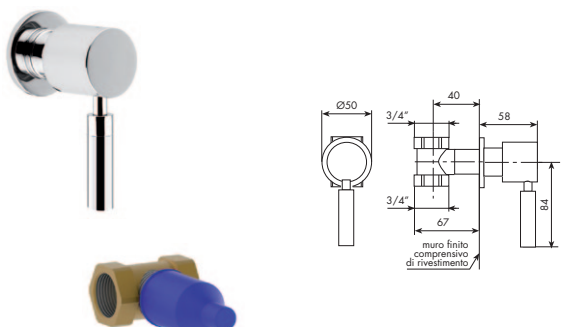

PARTI ESTERNE - CROMATO	
01-0108/E-01	€ 127,00
01-0108/E-39	€ 127,00

PARTI ESTERNE - ALTRE FINITURE	
XX-0108/E-XX	€ 127,00 x M*
XX-0108/E-39	€ 127,00 x M*

PARTE INCASSO	
054027 o 054028 info pag. 40	€ 65,00
PREZZO TOTALE	€ 192,00

0140/E + 884053

PASSO RAPIDO 3/4"

> vitone tradizionale
> abbinare a saracinesca
> ingressi da 3/4"

 884021
p. 151

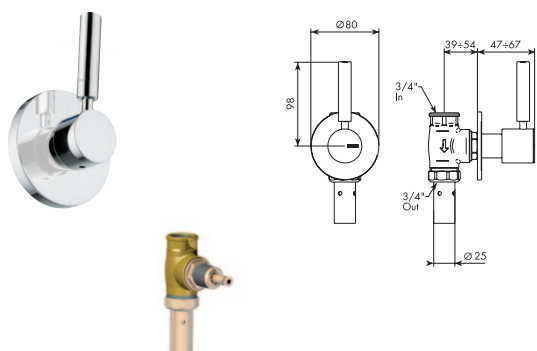

PARTI ESTERNE - CROMATO	
01-0140/E-01	€ 148,00
01-0140/E-39	€ 148,00

PARTI ESTERNE - ALTRE FINITURE	
XX-0140/E-XX	€ 148,00 x M*
XX-0140/E-39	€ 148,00 x M*

PARTE INCASSO	
884053 info pag. 42	€ 110,00
PREZZO TOTALE	€ 258,00

0140/E + 884054

PASSO RAPIDO 1"

> vitone tradizionale
> abbinare a saracinesca
> ingressi da 1"

 884021
p. 151

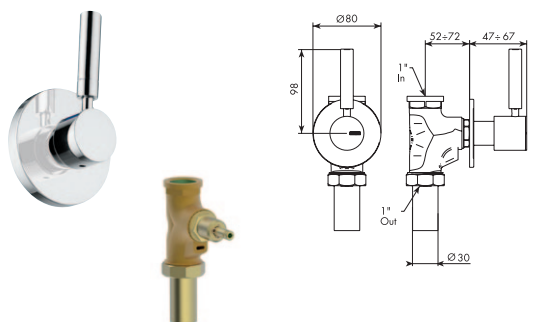

PARTI ESTERNE - CROMATO	
01-0140/E-01	€ 148,00
01-0140/E-39	€ 148,00

PARTI ESTERNE - ALTRE FINITURE	
XX-0140/E-XX	€ 148,00 x M*
XX-0140/E-39	€ 148,00 x M*

PARTE INCASSO	
884054 info pag. 42	€ 110,00
PREZZO TOTALE	€ 258,00

RICAMBI IMMEDIATI



XX = CODICE FINITURA RICHIESTA: per identificare codice corretto vedi pag. W-4
M* = MOLTIPLICATORE: per calcolare il prezzo delle altre finiture vedi tabella pag. W-4

0132/2/E + 035212

SARACINESCA

> attacchi da 3/4"

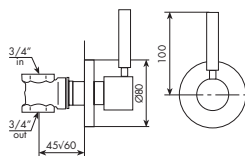

PARTI ESTERNE - CROMATO

01-0132/2/E-01	€	116,00
01-0132/2/E-39	€	116,00

PARTI ESTERNE - ALTRE FINITURE

XX-0132/2/E-XX	€	116,00 x M*
XX-0132/2/E-39	€	116,00 x M*

PARTE INCASSO

035212	info pag. 42	€	47,00
--------	--------------	---	-------

PREZZO TOTALE	€	163,00
----------------------	---	---------------

