

# ACCESSORI BAGNO CHARLOTTE

EQB DESIGN

INDICE / INDEX pag. W-2

ACC. BAGNO CHARLOTTE pag. W-4

Per tabella prezzi finiture e info  
tecniche vedi pag. 618 - Listino  
rubinetteria

**ACCESSORI BAGNO CHARLOTTE**



**0751** pag. W-4  
 PORTABICCHIERE SINGOLO DA PARETE  
 SINGLE WALL GLASS HOLDER



**0752** pag. W-4  
 PORTABICCHIERE SINGOLO D'APPOGGIO  
 SINGLE STAND GLASS HOLDER



**0753** pag. W-4  
 PORTASAPONE SINGOLO DA PARETE  
 SINGLE WALL SOAP DISH



**0753/1** pag. W-4  
 DISPENSER DA PARETE  
 WALL DISPENSER



**0754** pag. W-4  
 PORTASAPONE SINGOLO D'APPOGGIO  
 SINGLE STAND SOAP DISH



**0854/1** pag. W-5  
 DISPENSER D'APPOGGIO  
 STAND DISPENSER



**0755** pag. W-5  
 PORTABICCHIERE C/PORTASAPONE DA PARETE  
 WALL GLASS HOLDER AND SOAP DISH



**0756** pag. W-5  
 PORTABICCHIERE C/PORTASAPONE D'APPOGGIO  
 STAND GLASS HOLDER AND SOAP DISH



**0757** pag. W-5  
 PORTASAPONE DOPPIO DA PARETE  
 DOUBLE WALL SOAP DISH



**0758** pag. W-5  
 PORTASAPONE DOPPIO D'APPOGGIO  
 DOUBLE STAND SOAP DISH

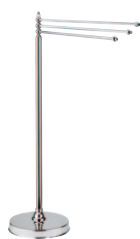

**0759** pag. W-6  
 PIANTANA PORTASALVIETTE  
 TOWEL RACK



**0760** pag. W-6  
 PORTASALVIETTE AD ANELLO  
 TOWEL RING



**0761** pag. W-6  
 PORTASALVIETTE SNODO  
 TOWEL RACK SWIVEL



**0762/30** pag. W-6  
 PORTASALVIETTE DA 30 CM  
 TOWEL RACK 30 CM



**0762/45** pag. W-6  
 PORTASALVIETTE DA 45 CM  
 TOWEL RACK 45 CM



**0762/60** pag. W-7  
 PORTASALVIETTE DA 60 CM  
 TOWEL RACK 60 CM



ACCESSORI BAGNO CHARLOTTE



**0763** pag. W-7  
**APPENDIABITO**  
**HANGER**



**0764** pag. W-7  
**PORTAROTOLO**  
**TOILET-ROLL HOLDER**



**0765** pag. W-7  
**PORTASCOPINO DA PARETE**  
**WALL TOILET-BRUSH HOLDER**



**0766** pag. W-7  
**PORTASCOPINO D'APPOGGIO**  
**STANDING TOILET-BRUSH HOLDER**



**0767** pag. W-8  
**SPECCHIO**  
**MIRROR**



**0768** pag. W-8  
**APPLIQUE**  
**APPLIQUE**



**0769** pag. W-8  
**MENSOLA CRISTALLO**  
**CRYSTAL SHELF**



0751

PORTABICCHIERE SINGOLO DA PARETE

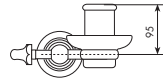
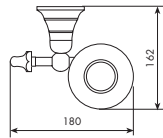

| CROMATO |          | ALTRE FINITURE |               |
|---------|----------|----------------|---------------|
| 01-0751 | € 119,00 | XX-0751        | € 119,00 x M* |

0752

PORTABICCHIERE SINGOLO D'APPOGGIO

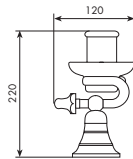

| CROMATO |          | ALTRE FINITURE |               |
|---------|----------|----------------|---------------|
| 01-0752 | € 143,00 | XX-0752        | € 143,00 x M* |

0753

PORTASAPONE SINGOLO DA PARETE

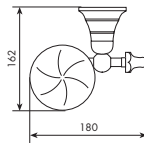

| CROMATO |          | ALTRE FINITURE |               |
|---------|----------|----------------|---------------|
| 01-0753 | € 109,00 | XX-0753        | € 109,00 x M* |

0753/1

DISPENSER DA PARETE

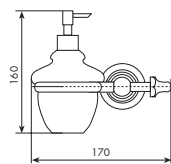

| CROMATO   |          | ALTRE FINITURE |               |
|-----------|----------|----------------|---------------|
| 01-0753/1 | € 173,00 | XX-0753/1      | € 173,00 x M* |

0754

PORTASAPONE SINGOLO D'APPOGGIO

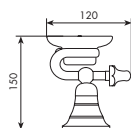

| CROMATO |          | ALTRE FINITURE |               |
|---------|----------|----------------|---------------|
| 01-0754 | € 133,00 | XX-0754        | € 133,00 x M* |



0854/1

DISPENSER D'APPOGGIO

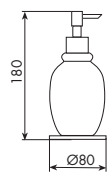

**CROMATO**  
01-0854/1 € 124,00

**ALTRE FINITURE**  
**XX-0854/1** € 124,00 x **M\***

0755

PORTABICCHIERE C/PORTASAPONE DA PARETE

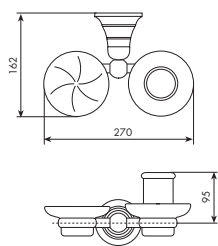

**CROMATO**  
01-0755 € 147,00

**ALTRE FINITURE**  
**XX-0755** € 147,00 x **M\***

0756

PORTABICCHIERE C/PORTASAPONE D'APPOGGIO

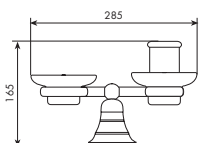

**CROMATO**  
01-0756 € 166,00

**ALTRE FINITURE**  
**XX-0756** € 166,00 x **M\***

0757

PORTASAPONE DOPPIO DA PARETE

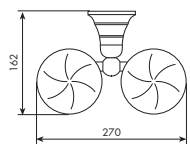

**CROMATO**  
01-0757 € 137,00

**ALTRE FINITURE**  
**XX-0757** € 137,00 x **M\***

0758

PORTASAPONE DOPPIO D'APPOGGIO

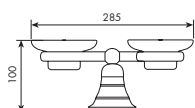

**CROMATO**  
01-0758 € 156,00

**ALTRE FINITURE**  
**XX-0758** € 156,00 x **M\***

0759

PIANTANA PORTASALVIETTE

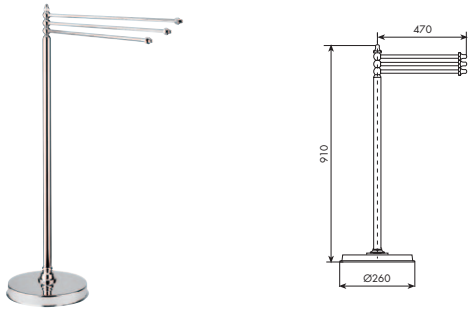

CROMATO  
01-0759 € 527,00

ALTRE FINITURE  
XX-0759 € 527,00 x M\*

0760

PORTASALVIETTE AD ANELLO

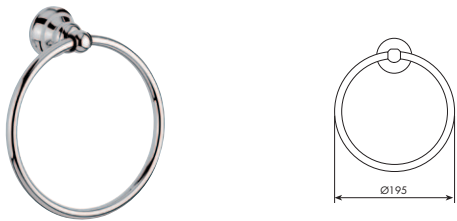

CROMATO  
01-0760 € 112,00

ALTRE FINITURE  
XX-0760 € 112,00 x M\*

0761

PORTASALVIETTE SNODO



CROMATO  
01-0761 € 226,00

ALTRE FINITURE  
XX-0761 € 226,00 x M\*

0762/30

PORTASALVIETTE DA 30 CM

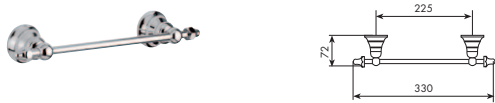

CROMATO  
01-0762/30 € 163,00

ALTRE FINITURE  
XX-0762/30 € 163,00 x M\*

0762/45

PORTASALVIETTE DA 45 CM



CROMATO  
01-0762/45 € 170,00

ALTRE FINITURE  
XX-0762/45 € 170,00 x M\*



0762/60

PORTASALVIETTE DA 60 CM

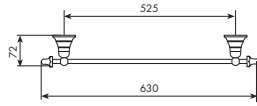

**CROMATO**  
01-0762/60 € 177,00

**ALTRE FINITURE**  
**XX-0762/60** € 177,00 x **M\***

0763

APPENDIABITO

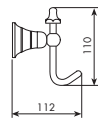

**CROMATO**  
01-0763 € 97,00

**ALTRE FINITURE**  
**XX-0763** € 97,00 x **M\***

0764

PORTAROTOLO

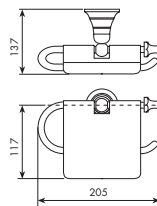

**CROMATO**  
01-0764 € 152,00

**ALTRE FINITURE**  
**XX-0764** € 152,00 x **M\***

0765

PORTASOPINO DA PARETE

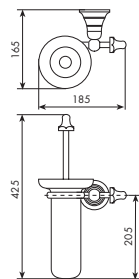

**CROMATO**  
01-0765 € 194,00

**ALTRE FINITURE**  
**XX-0765** € 194,00 x **M\***

0766

PORTASOPINO D'APPOGGIO

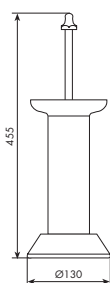

**CROMATO**  
01-0766 € 93,00

**ALTRE FINITURE**  
**XX-0766** € 93,00 x **M\***

0767

SPECCHIO

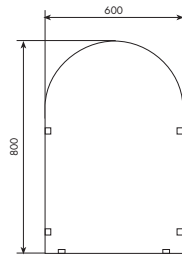

| CROMATO |          | ALTRE FINITURE |               |
|---------|----------|----------------|---------------|
| 01-0767 | € 653,00 | XX-0767        | € 653,00 x M* |

0768

APPLIQUE

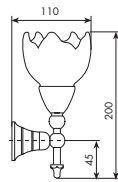

| CROMATO |          | ALTRE FINITURE |               |
|---------|----------|----------------|---------------|
| 01-0768 | € 223,00 | XX-0768        | € 223,00 x M* |

0769

MENSOLA CRISTALLO

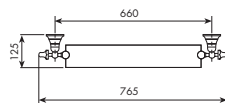

| CROMATO |          | ALTRE FINITURE |               |
|---------|----------|----------------|---------------|
| 01-0769 | € 255,00 | XX-0769        | € 255,00 x M* |

