

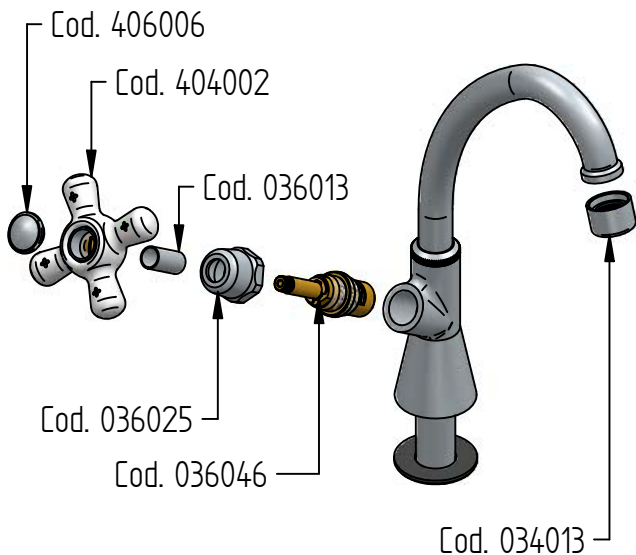

RICAMBI / SPARE PARTS



COD. 035046 COD. 404002



COD. 036013 COD. 406006



COD. 036025 COD. 034013

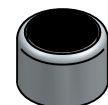

joconde

ISTRUZIONI DI INSTALLAZIONE / INSTALLATION INSTRUCTION

ART. 4002



ART. 4005/3

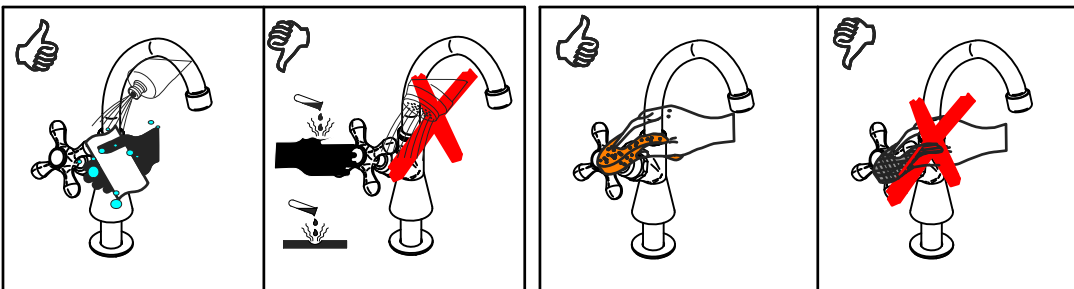

MANUTENZIONE E PULIZIA

Per una corretta manutenzione e pulizia di questo prodotto, raccomandiamo alcuni semplici accorgimenti:

- Utilizzare detersivi neutri, spruzzando il prodotto direttamente su un panno morbido onde evitare infiltrazioni
- Evitare sempre il contatto con prodotti acidi o abrasivi
- Risciacquare bene con abbondante acqua per eliminare eventuali residui ed asciugare sempre con un panno morbido
- Effettuare una pulizia periodica al fine di prevenire le formazioni calcaree

La BELLOSTA CARLO & C. non è RESPONSABILE di danni derivati dall'utilizzo di prodotti impropri per la pulizia.

MAINTENANCE AND CLEANING

For a proper maintenance and cleaning, we recommend the following:

- Use neutral detergents, avoiding to spray directly on taps to avoid residual infiltration
- Avoid contact with acid or abrasive products
- Rinse with water and always dry with a clean cloth to avoid residue of detergent
- Perform a periodic cleaning to prevent limestone deposits

BELLOSTA CARLO & C. cannot be held responsible for damages due to an improper use of detergents



1 IMPORTANTISSIMO



Per installatore: Al fine di garantire la durata del prodotto installare rubinetti con filtro da pulire periodicamente. Effettuare risciacquo delle tubazioni prima di installare il prodotto (PUNTO 1)
 For installer: In order to guarantee a long duration of the product install valves with filter, which have to be regularly cleaned (POINT 1). Carry out the rinsing of the pipes before install the tap.

2

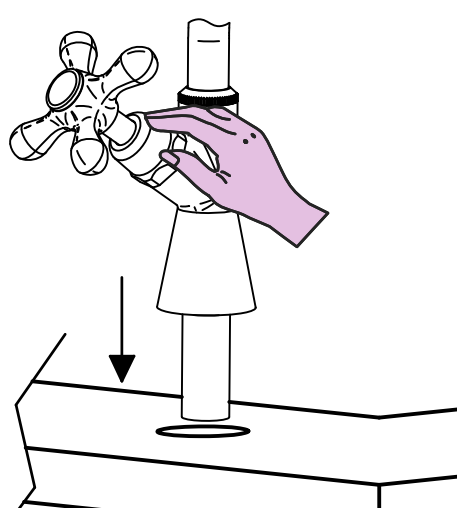

SOSTITUZIONE AERATORE / AERATOR REPLACEMENT

1

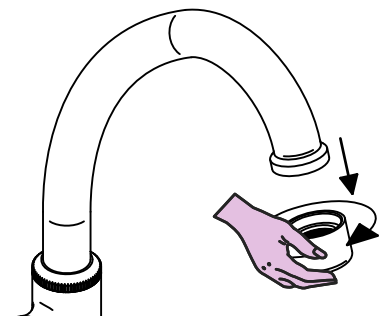

3

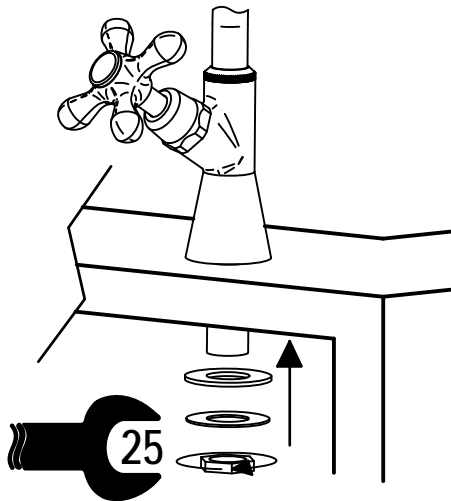

SOSTITUZIONE VITONE / VALVE REPLACEMENT

Prima di iniziare le operazioni di sostituzione del vitone assicurarsi che l'acqua dell'impianto principale sia chiusa.

Before starting replacement of the valve, ensure that water system has been turned off and empty remaining water.

1

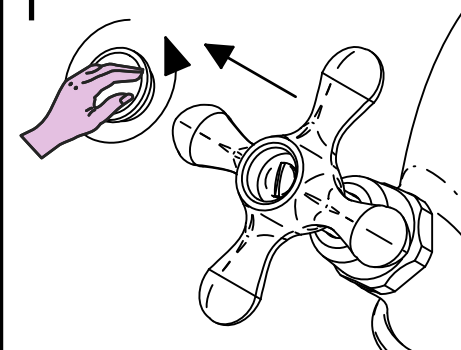

2

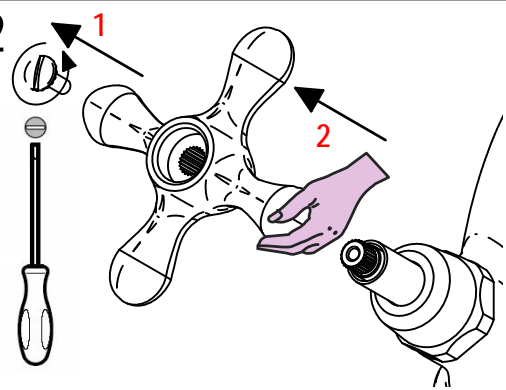

4

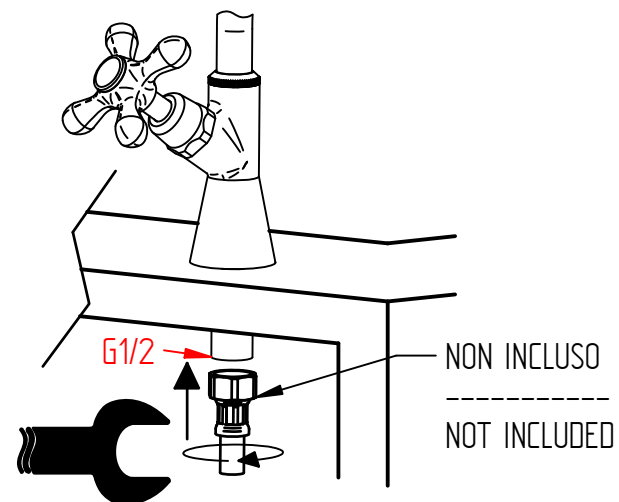

3

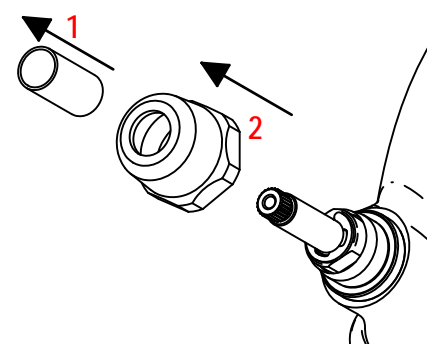

4

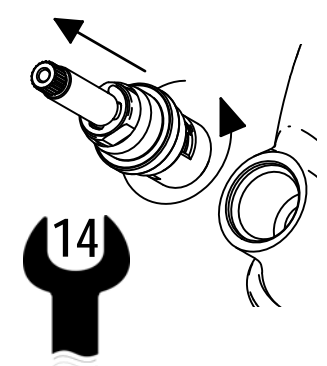

Per qualsiasi richiesta di informazioni, preghiamo contattare l'Ufficio Tecnico presso: info@bellostarubinetterie.com
 For any technical inquiries, please contact the Technical Office at: info@bellostarubinetterie.com ©