

Volendo installare il comando LED (oggetto B, in figura) nella zona di sicurezza Z3, si può scegliere di escludere il dispositivo a tenuta, proposta da Bellostà Rubinetterie, in favore di un comando tradizionale, dotato almeno di un pulsante, con la placca di finitura in linea con le specifiche esigenze del cliente. Una soluzione concepita per fornire la massima scelta di forme, finiture e materiali.
N.B. Le due soluzioni proposte per l'installazione del comando LED possono essere combinate, dando così la possibilità di avere due comandi, uno all'interno del box doccia ed uno nell'ambiente bagno.

CARATTERISTICHE IMPIANTO ELETTRICO

Caratteristiche elettriche e limite di utilizzo della cromoterapia connessa a **minitouch**:
Input: 190-250 V ac, 50-60 Hz, 0.10A - **Output:** DC3x 12V 1A 200 Hz.
Caratteristiche elettriche e limite di utilizzo dell'alimentatore per **minitouch** (non USA): **Input:** AC 110-220V 50-60 Hz 1,2A - **Output:** DC 5V 1A.
Caratteristiche elettriche e limite di utilizzo della cromoterapia connessa a **touchscreen**:
Input: 190-250 V ac, 50-60 Hz, 0.10A - **Output:** DC3x 24V 2A 200 Hz.
Caratteristiche elettriche e limite di utilizzo dell'alimentatore per **touchscreen** (non USA): **Input:** AC 110-220V 50-60 Hz 1,2A - **Output:** DC 12V 3,5A.
Caratteristiche elettriche e limite di utilizzo dell'alimentatore per controllo da pulsante (non fornito): **Input:** 190-260V ac 50-60Hz, 0,15 A - **Output:** 3x0,35 A 24V (max).

- A: Centralina e trasformatore (installabile solo nella zona di sicurezza Z3)
- B: Tastiera di comando luce (installabile nelle zone Z1, Z2 e Z3)
- C: Uscita cavo gestione LED (installazione vincolata alla zona Z1)
- Cavo da A a C: lunghezza max 5m, sezione 1 mm² schermato, poli 4
- Cavo da A a B: lunghezza max 5m, sezione 0,5 mm², poli 4

It is possible to use a traditional system provided with minimum one switch along with the finish plate to meet the client's specific requirements instead of the hydraulic system suggested by Bellostà Rubinetterie, in order to set up the control LED (object B, in the picture) within the security area Z3. A solution given in order to offer the widest choice of shapes, finishes and materials. P.S. Both solutions suggested for the fitting-up of the LED control can be combined to have two systems, one inside the shower box and one within the bathroom.

ELECTRIC IMPIANT FEATURES

Electric features and limit utilization of the chrome therapy linked at **minitouch**:
Input: 190-250 V ac, 50-60 Hz, 0.10A - **Output:** DC3x 12V 1A 200 Hz.
Electric features and limit utilization of the alimentary for **minitouch** (no Usa):
Input: AC 110-220V 50-60 Hz 1,2A - **Output:** DC 5V 1A.
Electric features and limit utilization of the chrome therapy linked at **touchscreen**:
Input: 190-250 V ac, 50-60 Hz, 0.10A - **Output:** DC3x 24V 2A 200 Hz.
Electric features and limit utilization of the alimentary for **touchscreen** (no Usa):
Input: AC 110-220V 50-60 Hz 1,2A - **Output:** DC 12V 3,5A.
Electric features and limit utilization of the alimentary driver pulse (not included):
Input: 190-260V ac 50-60Hz, 0,15 A - **Output:** 3x0,35 A 24V (max).

- A: Central and transformer (mounted only in the safe zone Z3)
- B: Driver light keyboard (mounted only in the safe zone Z1, Z2 e Z3)
- C: Out LED cable (mounted only in the zone Z1)
- Cable from A to C: max length 5m, section 1 mm² shielded, poles 4
- Cable from A to B: max length 5m, section 0,5 mm², poles 4

Istruzioni revivre classic

Art.1021/CR1

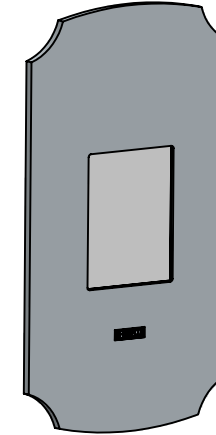

RICAMBI / SPARE PARTS

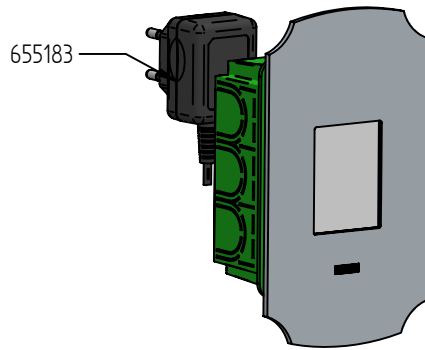

Cod.655183

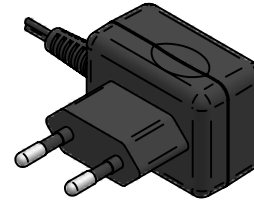

OUT 5VDC

1



1 ELETTRICISTA NECESSARIO
1 ELECTRICAL MAN NEEDED

2

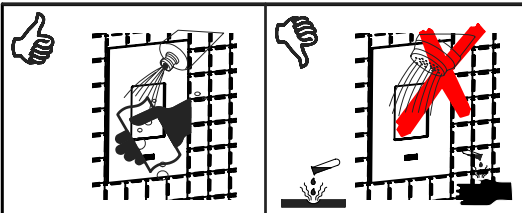
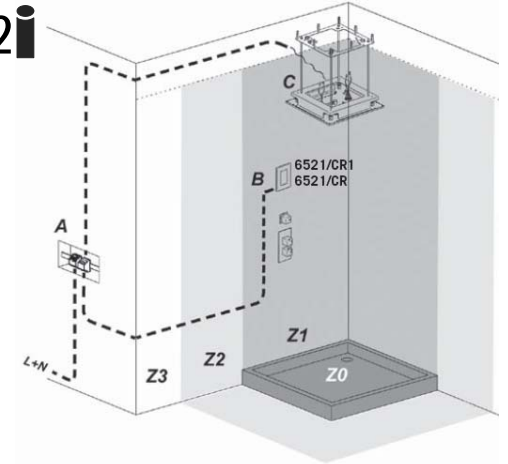

MANUTENZIONE E PULIZIA

Per una corretta manutenzione e pulizia di questo prodotto, raccomandiamo alcuni semplici accorgimenti:

- Utilizzare detergenti neutri, spruzzando il prodotto direttamente su un panno morbido onde evitare infiltrazioni
 - Evitare sempre il contatto con prodotti acidi o abrasivi
 - Risciacquare bene con abbondante acqua per eliminare eventuali residui ed asciugare sempre con un panno morbido
 - Effettuare una pulizia periodica al fine di prevenire le formazioni calcaree
- La BELLOSTA CARLO & C. non è RESPONSABILE di danni derivati dall'utilizzo di prodotti impropri per la pulizia.

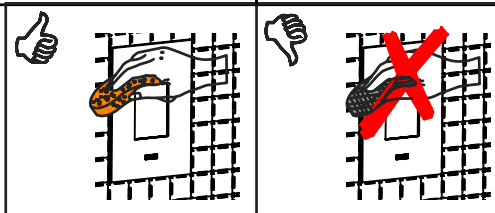

MAINTENANCE AND CLEANING

For a proper maintenance and cleaning, we recommend the following:

- Use **neutral detergents**, avoiding to spray directly on taps to avoid residual infiltration
- **Avoid** contact with acid or abrasive products
- **Rinse** with water and **always dry** with a clean cloth to avoid residue of detergent
- Perform a **periodic cleaning** to prevent limestone deposits

BELLOSTA CARLO & C. cannot be held responsible for damages due to an improper use of detergents

3



PREVEDERE UN INTERRUPTORE GENERALE DI SICUREZZA SECONDO QUANTO PREVISTO DALLE NORMATIVE VIGENTI



NON COMPRESO
NOT INCLUDED

PLEASE PROVIDE FOR A GENERAL SAFE SWITCH UNDER WHICH IS IN REFERENCE OF THE ACTUAL LAWS

MADE IN ITALY

Questo prodotto è stato realizzato interamente in Italia con l'utilizzo di materie prime di altissima qualità

DESIGN
EOB

MADE IN ITALY

This product has been entirely manufactured in Italy, by top quality raw materials.



8  COLLEGARE ALLA LINEA PROTETTA (VEDI PUNTO 3)

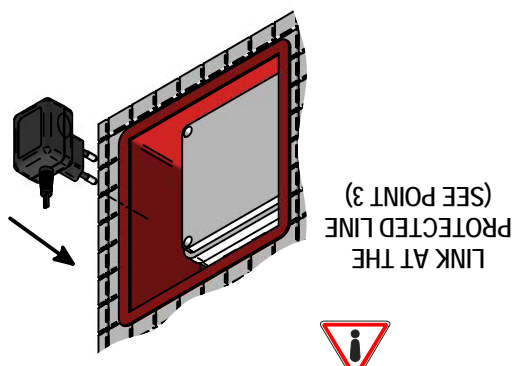

9  **ROSSO**
B1
BLU
B

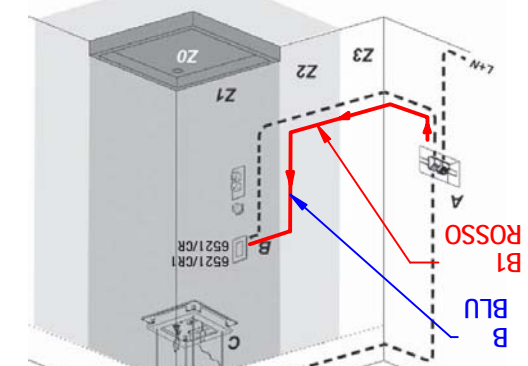

6  **C A B**
B1
INGOMBRI 150
59
33
65
62

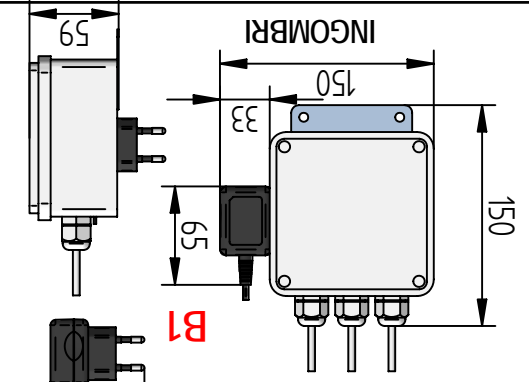

7  COLLEGARE ALLA LINEA PROTETTA (VEDI PUNTO 3)

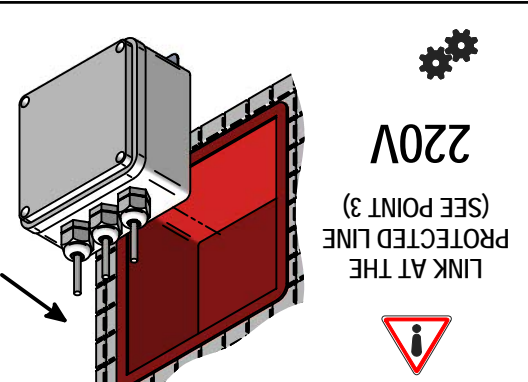

5  FUORI BOX DOGGIA ZONA Z3 OUTSIDE THE SHOWER BOX AREA Z3

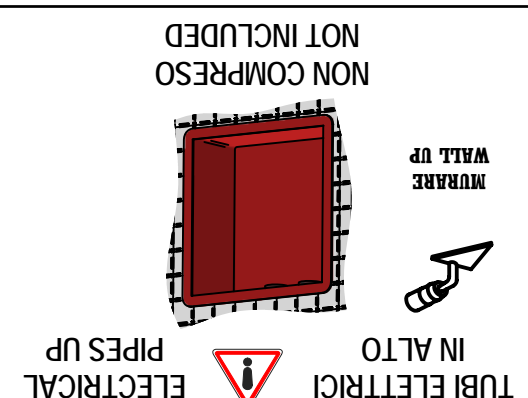

4  NEL BOX DOGGIA INSIDE THE SHOWER BOX

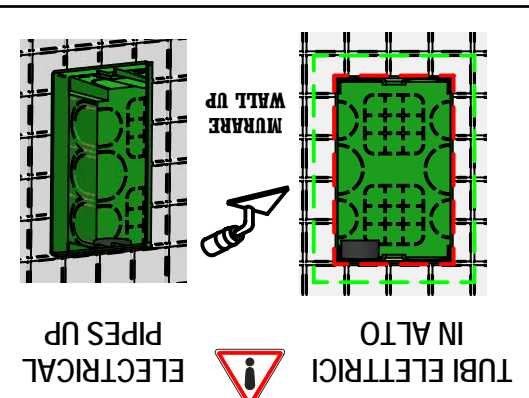

14  **SILICONARE ALLE PIASTRELLE**

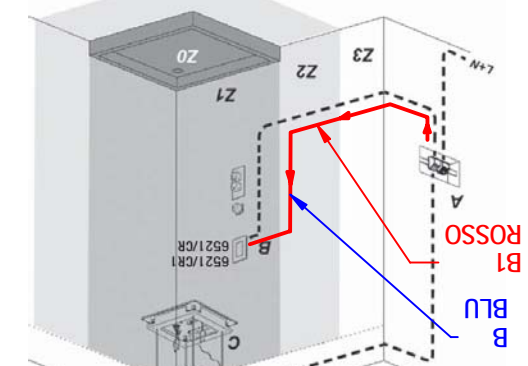

13  IN CASO DI DOPIO FARETTO COLLEGARE I FARETTI TRA LORO E QUELLO CON CAVO DOPIO CON IL CAVO CENTRALINA

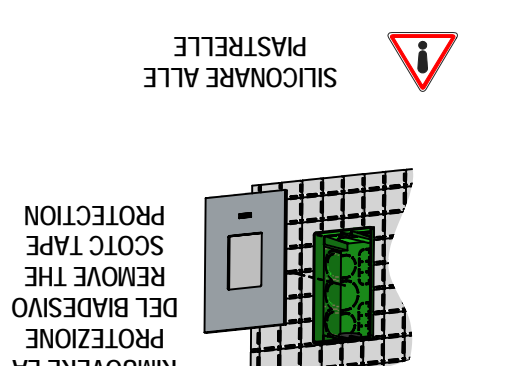

12  **BLU**
B
ROSSO
B1

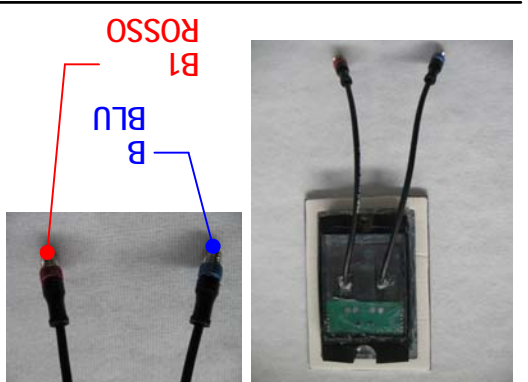

11  **NON COMPRESO MURARE WALL UP**

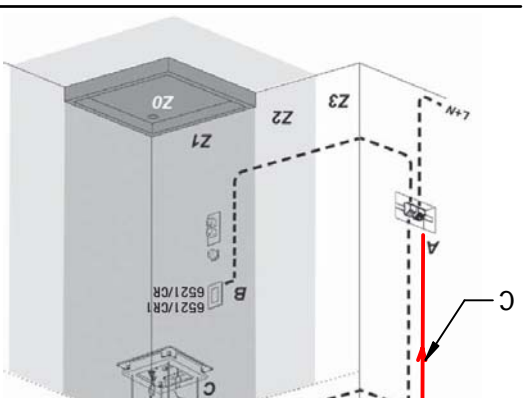

10  **IN ALTO TUBI ELETTRICI ELECTRICAL PIPES UP**

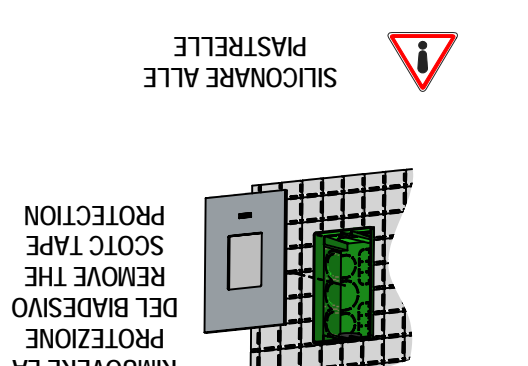

15!  **ACCESSIONE ROSSO ON RED**
ACCESSIONE VERDE ON GREEN
ACCESSIONE BLU ON BLUE
ACCESSIONE CICLO RGB ON RGB CYCLE
SPEGNIMENTO OFF

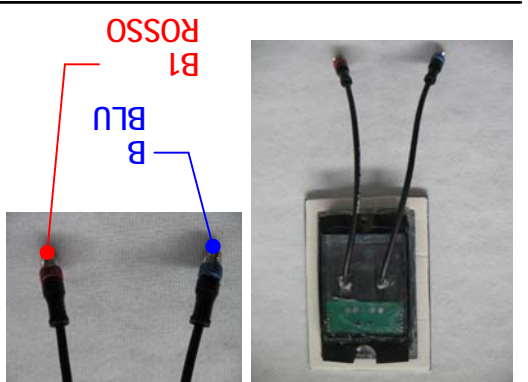

15!  **ACCESSIONE ROSSO ON RED**
ACCESSIONE VERDE ON GREEN
ACCESSIONE BLU ON BLUE
ACCESSIONE CICLO RGB ON RGB CYCLE
SPEGNIMENTO OFF

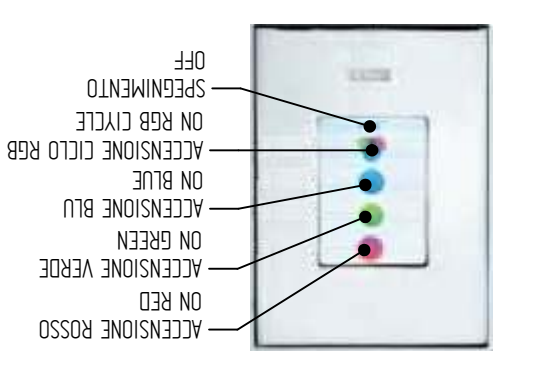

11  **NON COMPRESO MURARE WALL UP**

