

nöel

ISTRUZIONI DI INSTALLAZIONE / INSTALLATION INSTRUCTION

ART. 1501/A



ART. 1501/B



Per installatore: Al fine di garantire la durata del prodotto installare rubinetti con filtro da pulire periodicamente. Effettuare risciacquo delle tubazioni prima di installare il prodotto (PUNTO 1)

Eventuali residui se finissero all'interno della cartuccia potrebbero causarne il danneggiamento

For installer: In order to guarantee a long duration of the product install valves with filter, which have to be regularly cleaned (POINT 1). Carry out the rinsing of the pipes before install the tap.

Some external materials may damage the cadrige if not removed before the installation.

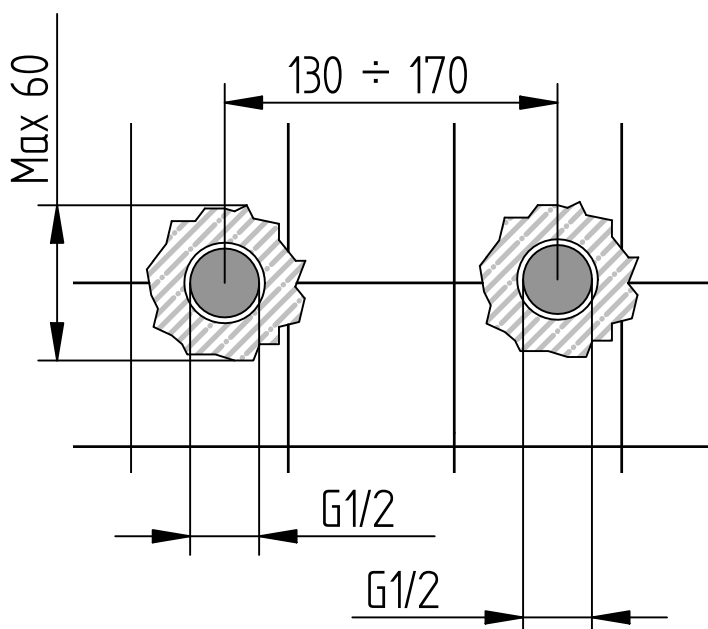

1 IMPORTANTISSIMO



A

2

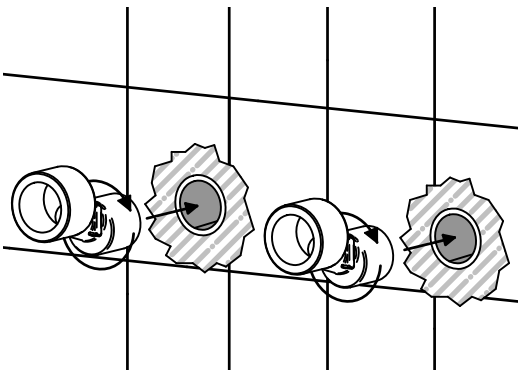
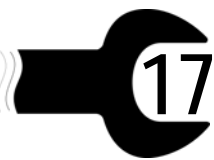

3

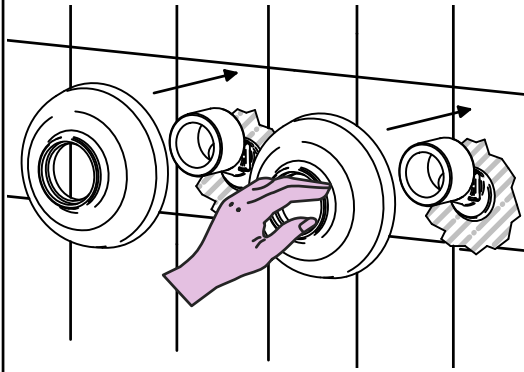

4

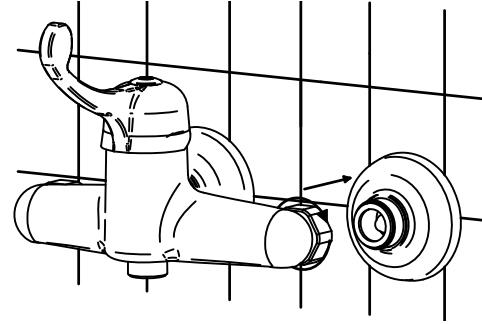
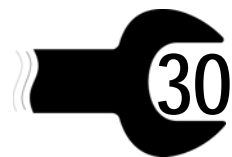

5

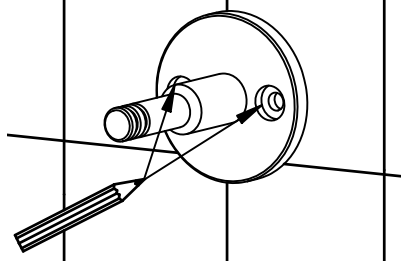

6

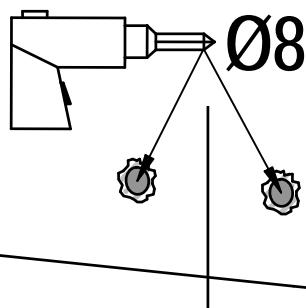

7

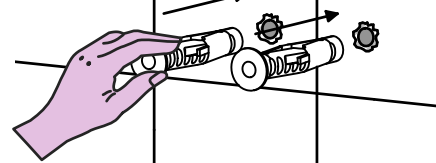

8

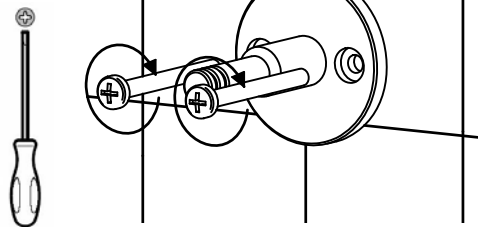

9

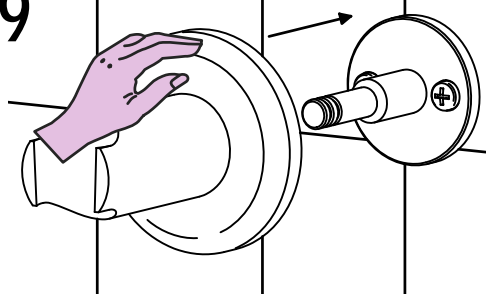

10

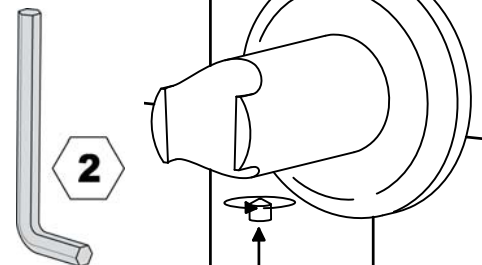

11 SOLO PER 1001/B
ONLY FOR 1001/B

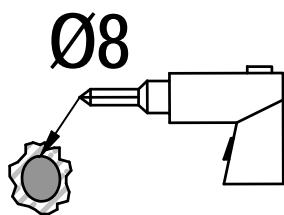

12

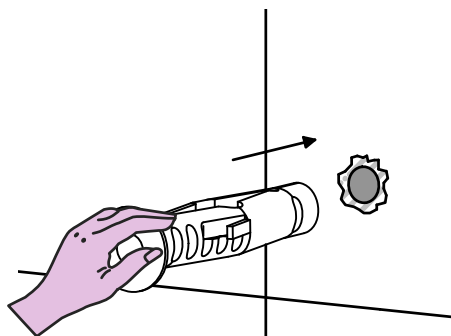

13

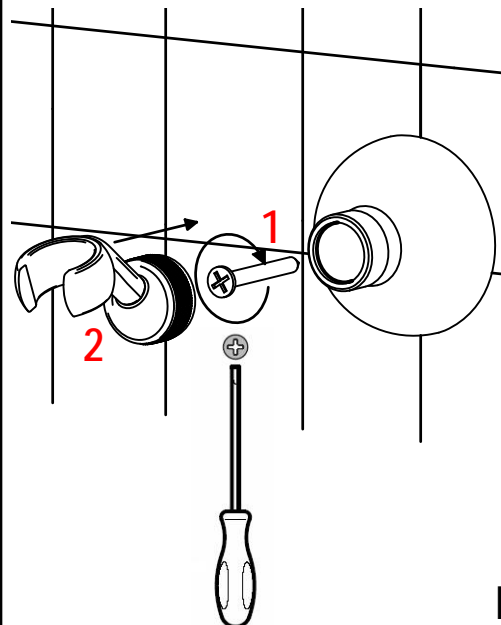



SOSTITUZIONE AERATORE / AERATOR REPLACEMENT

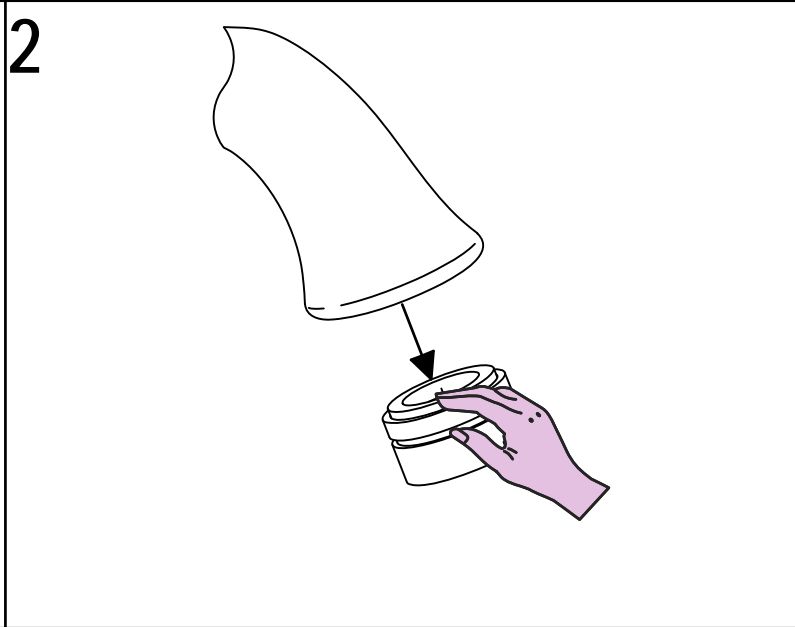
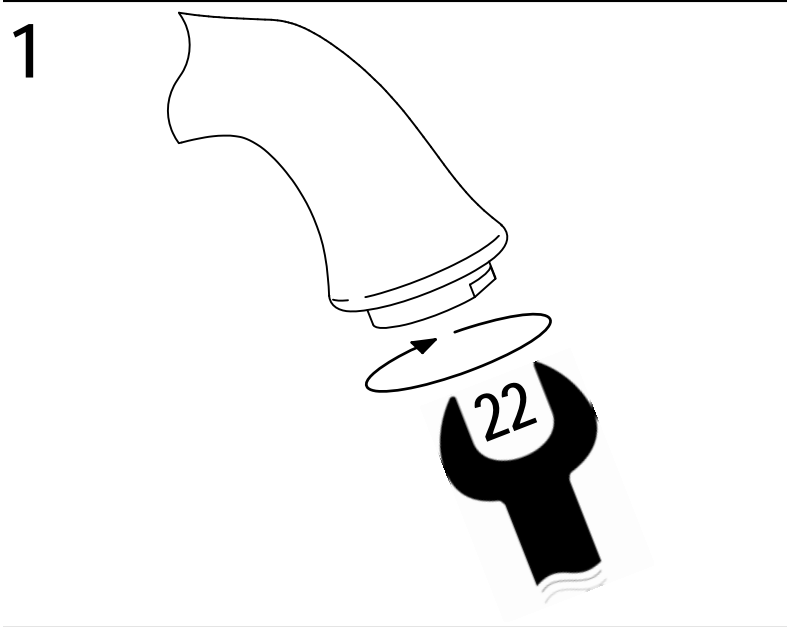

SOSTITUZIONE CARTUCCIA / CARTRIDGE REPLACEMENT

Prima di iniziare le operazioni di sostituzione della cartuccia assicurarsi che l'acqua dell'impianto principale sia chiusa e che la cartuccia sia svuotata da residui di acqua.

Before starting replacement of cartridge, ensure that water system has been turned off and empty remaining water.

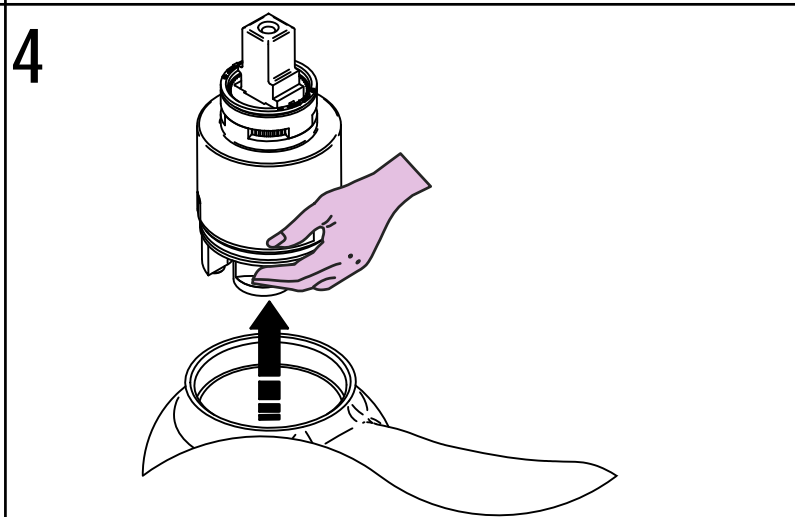
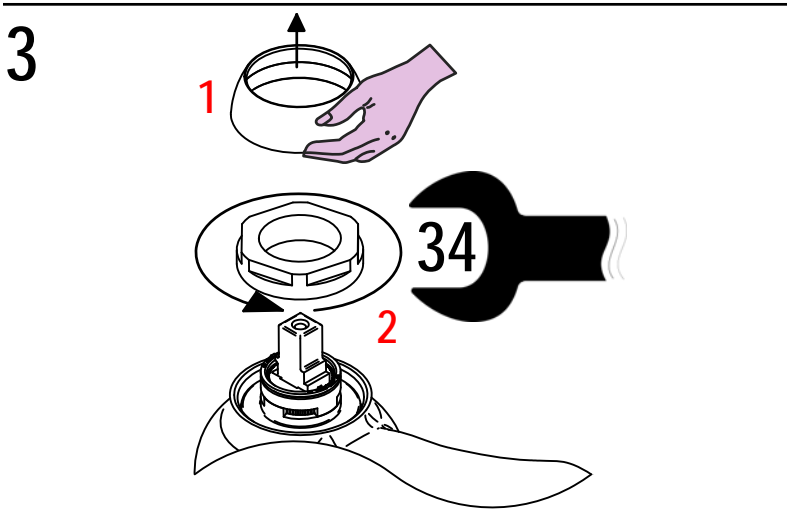
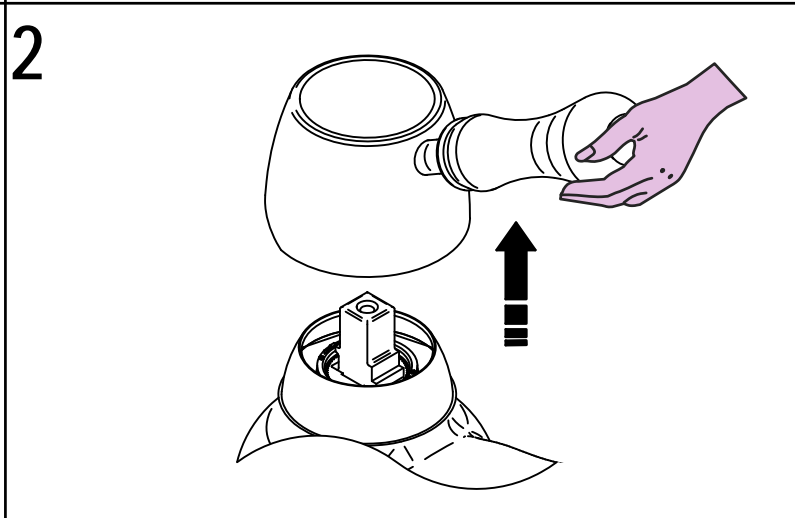
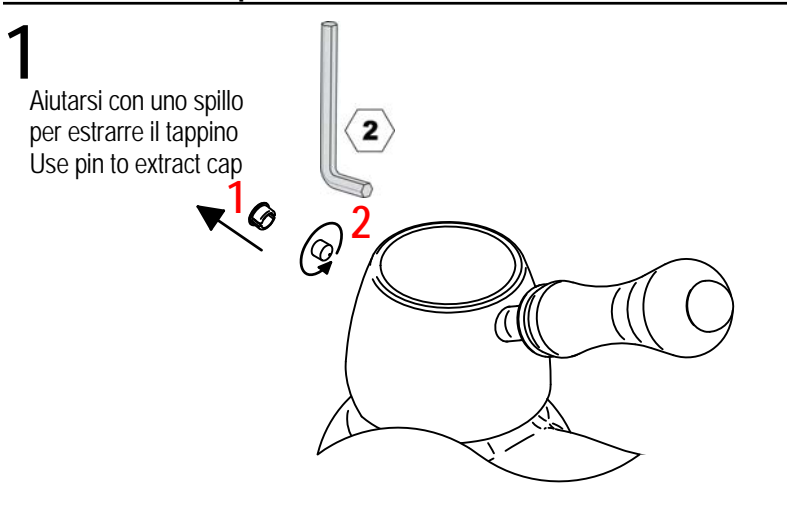





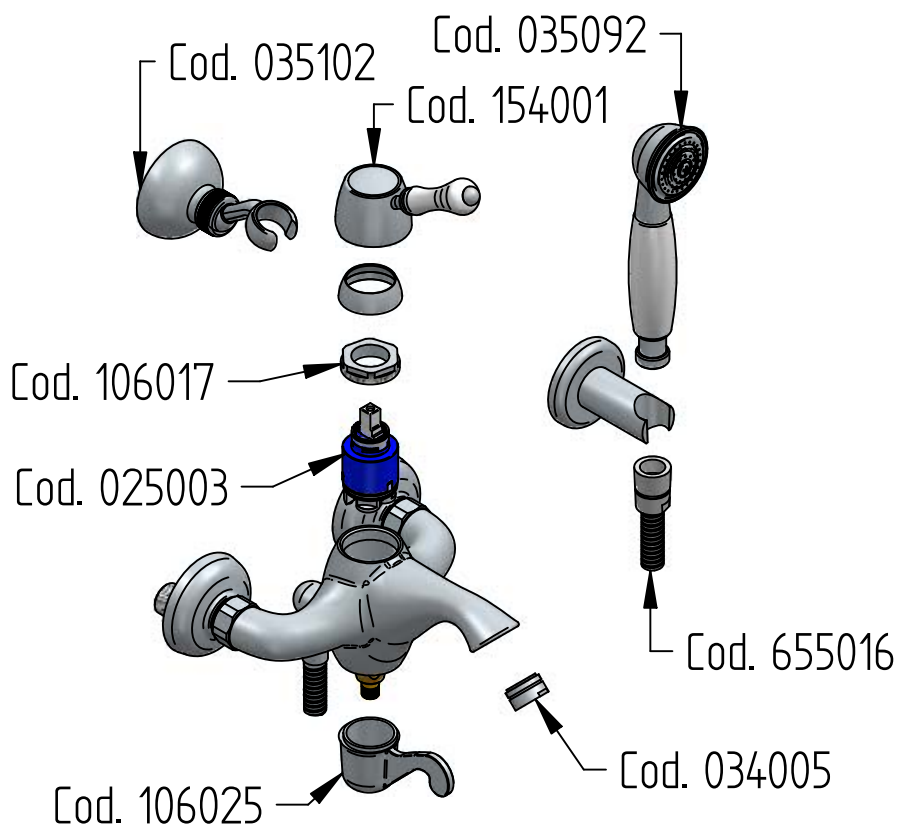

Per qualsiasi richiesta di informazioni, preghiamo contattare l'Ufficio Tecnico presso:
info@bellostarubinetterie.com
 For any technical inquiries, please contact the Technical Office at: info@bellostarubinetterie.com

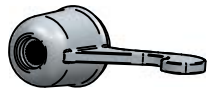

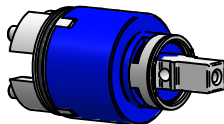
RICAMBI / SPARE PARTS



COD. 154001 	COD. 106025 
COD. 106017 	COD. 025003 
COD. 035102 	COD. 034005 
COD. 035092 	COD. 655016 

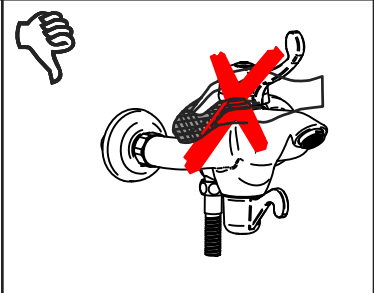
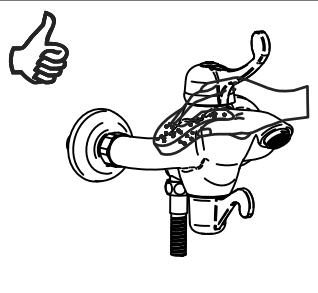
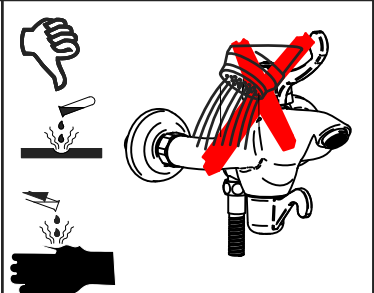
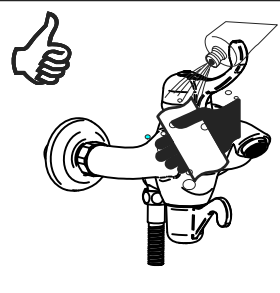

MANUTENZIONE E PULIZIA

Per una corretta manutenzione e pulizia di questo prodotto, raccomandiamo alcuni semplici accorgimenti:

- Utilizzare **detergenti neutri**, spruzzando il prodotto direttamente su un panno morbido onde evitare infiltrazioni
- Evitare **sempre** il contatto con prodotti acidi o abrasivi
- **Risciacquare bene** con abbondante acqua per eliminare eventuali residui ed **asciugare sempre** con un panno morbido
- Effettuare una **pulizia periodica** al fine di prevenire le formazioni calcaree

La BELLOSTA CARLO & C. non è RESPONSABILE di danni derivati dall'utilizzo di prodotti impropri per la pulizia.

MADE IN ITALY

Questo prodotto è stato realizzato interamente in Italia con l'utilizzo di materie prime di altissima qualità

DESIGN
EQB

MAINTENANCE AND CLEANING

For a proper maintenance and cleaning, we recommend the following:

- Use **neutral detergents**, avoiding to spray directly on taps to avoid residual infiltration
- **Avoid** contact with acid or abrasive products
- **Rinse** with water and **always dry** with a clean cloth to avoid residue of detergent
- Perform a **periodic cleaning** to prevent limestone deposits

BELLOSTA CARLO & C. cannot be held responsible for damages due to an improper use of detergents

MADE IN ITALY

This product has been entirely manufactured in Italy, by top quality raw materials.



Rubinetti d'autore Made in Italy