

edward lever

Istruzioni di installazione / Installation instruction

Art. 0805/L
Art. 0805/LL

Art. 0805/4/L
Art. 0805/4/LL

Art. 0807/7/L
Art. 0807/7/LL

Art. 0807/4/L
Art. 0807/4/LL



Per installatore: Al fine di garantire la durata del prodotto installare rubinetti sottolavabo con filtro da pulire periodicamente. Effettuare risciacquo delle tubazioni prima di installare il prodotto (PUNTO 1) Eventuali residui se finissero all'interno della cartuccia potrebbero causare il danneggiamento
For installer: In order to guarantee a long duration of the product install angle valves with filter, which have to be regularly cleaned (POINT 1). Carry out the rinsing of the pipes before install the tap. Some external materials may damage the cartridge if not removed before installation

1

IMPORTANTISSIMO



2

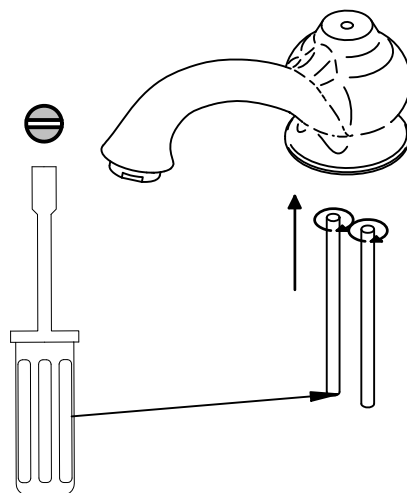

3

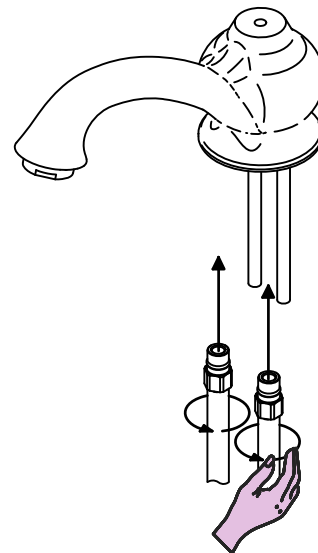

4

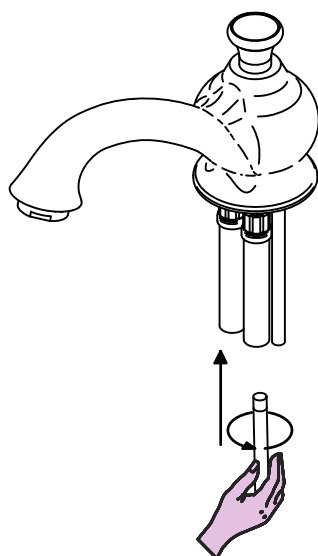

5

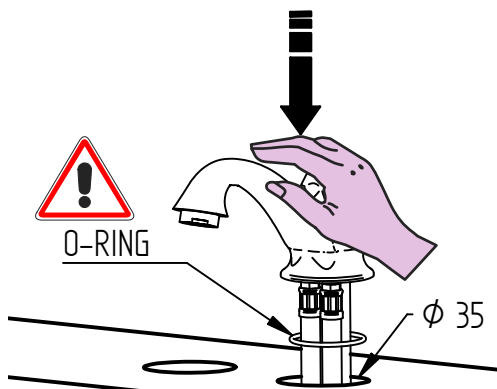

6

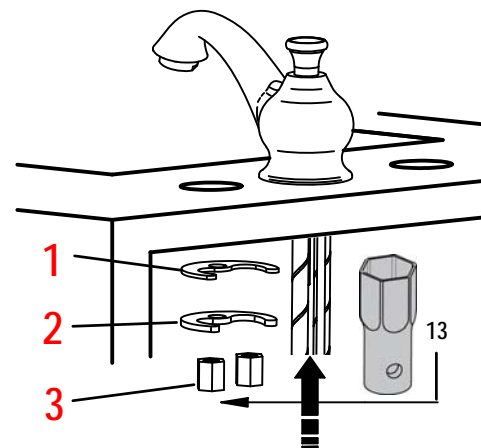

MADE IN ITALY

Questo prodotto è stato realizzato interamente in Italia con l'utilizzo di materie prime di altissima qualità

DESIGN
EQB

MADE IN ITALY

This product has been entirely manufactured in Italy, by top quality raw materials.

BELLOSTA
rubinetterie
Rubinetti d'autore dedicati a te

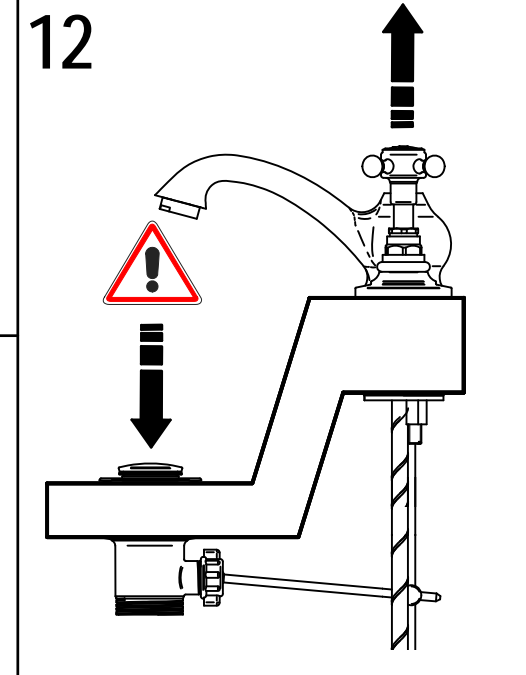
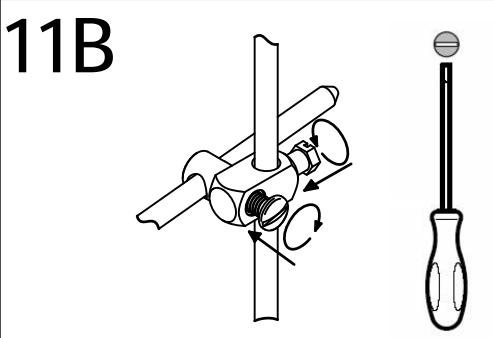
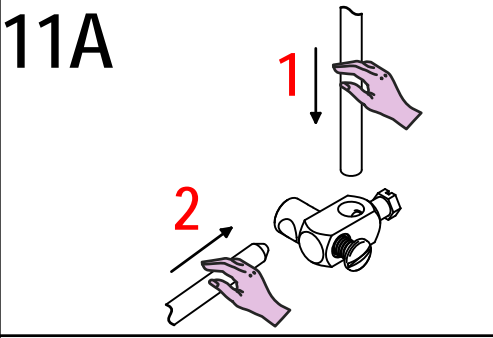
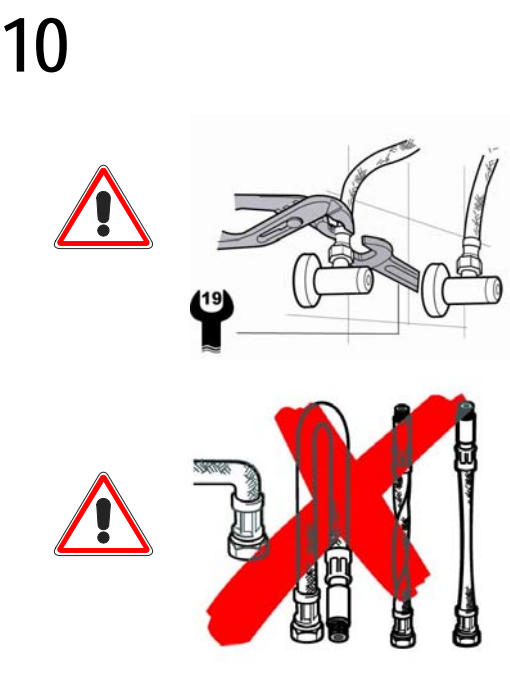
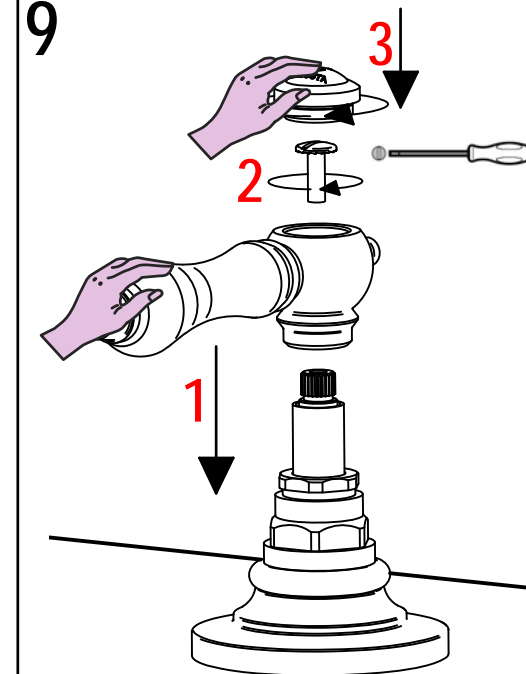
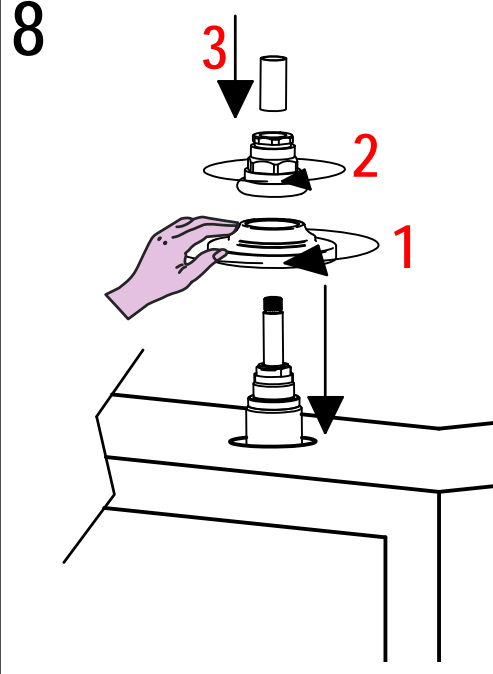
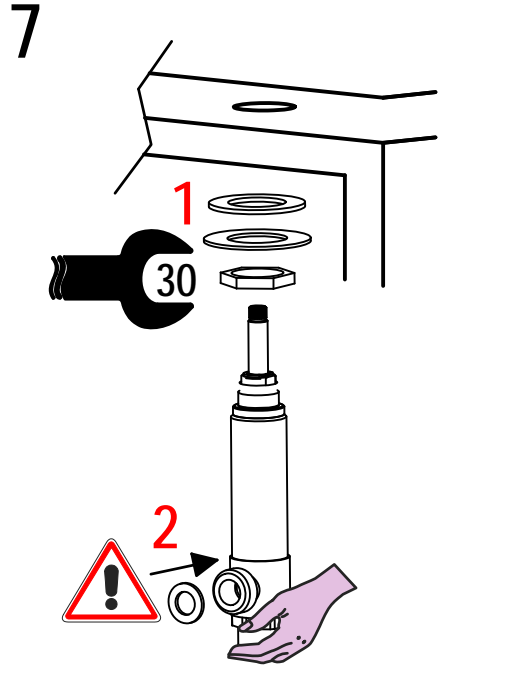

 **SOSTITUZIONE AERATORE / AERATOR REPLACEMENT**

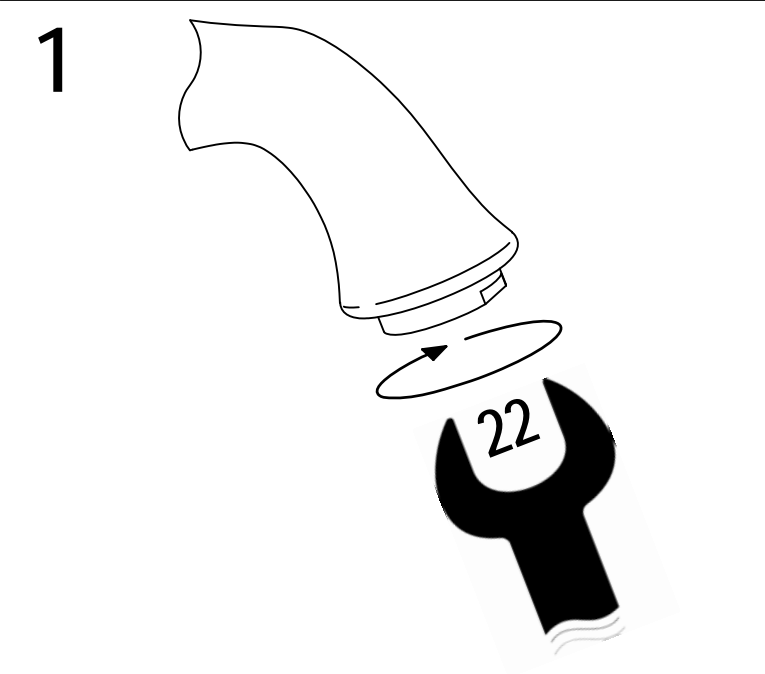



SOSTITUZIONE SNODINO BIDET/ JOINT BIDET REPLACEMENT

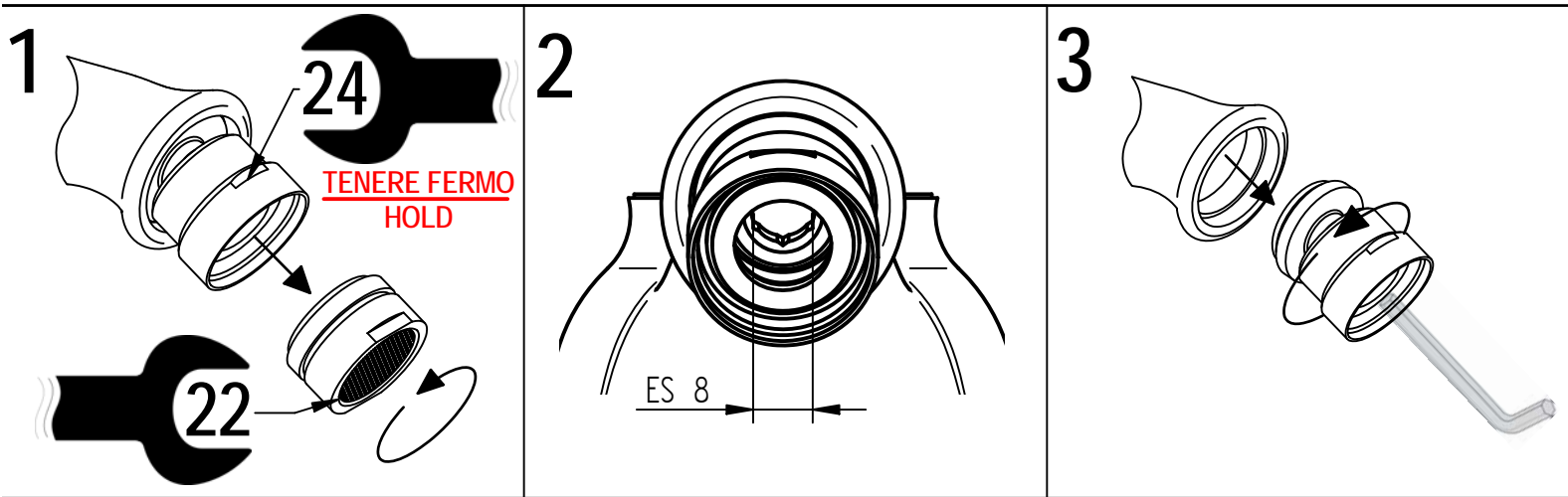

SOSTITUZIONE VITONE / VALVE REPLACEMENT

Prima di iniziare le operazioni di sostituzione del vitone assicurarsi che l'acqua dell'impianto principale sia chiusa.

Before starting replacement of the valve, ensure that water system has been turned off and empty remaining water.

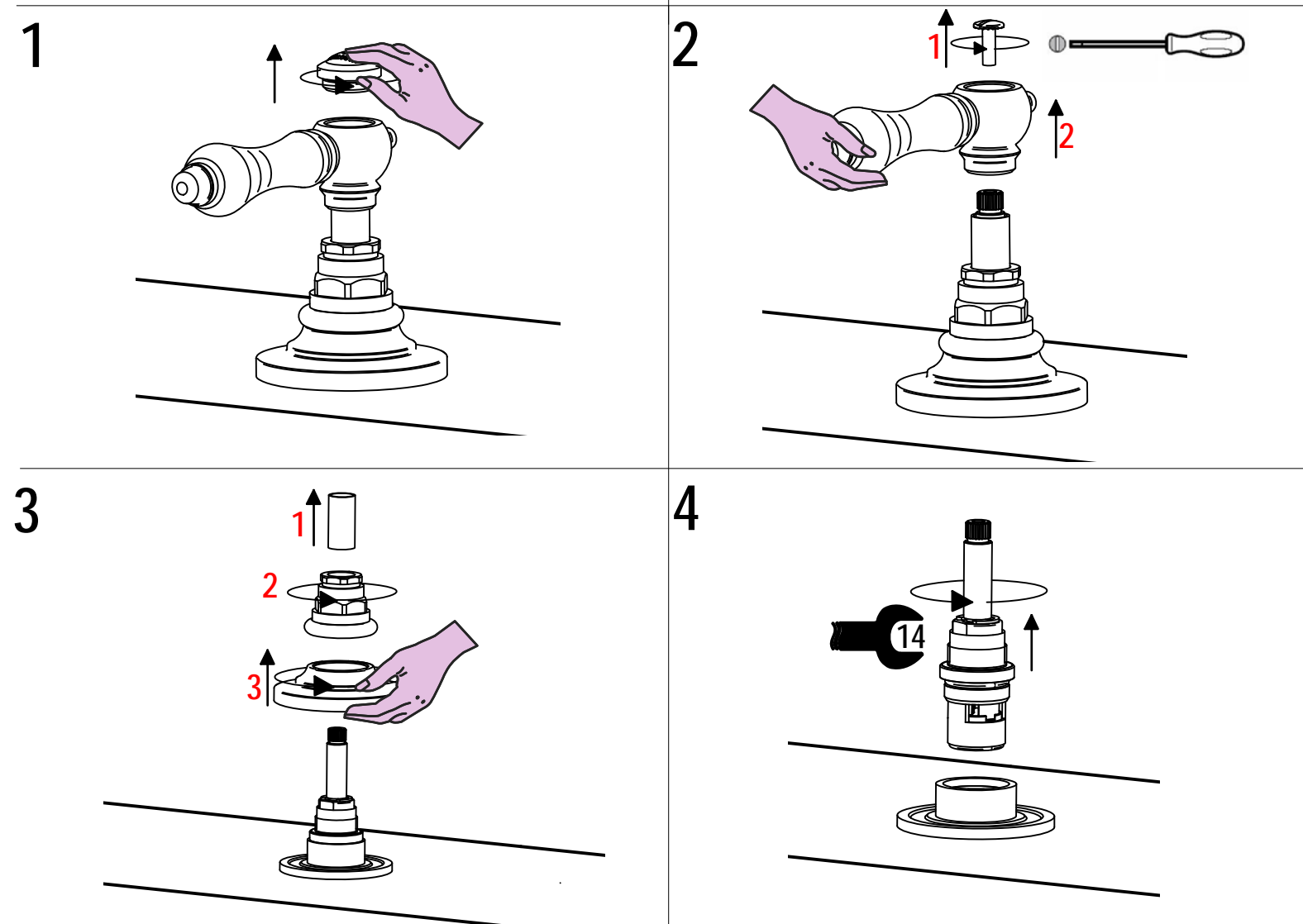

Per qualsiasi richiesta di informazioni, preghiamo contattare l'Ufficio Tecnico presso:
info@bellostarubinetterie.com
 For any technical inquiries, please contact the Technical Office at: info@bellostarubinetterie.com C



RICAMBI / SPARE PARTS

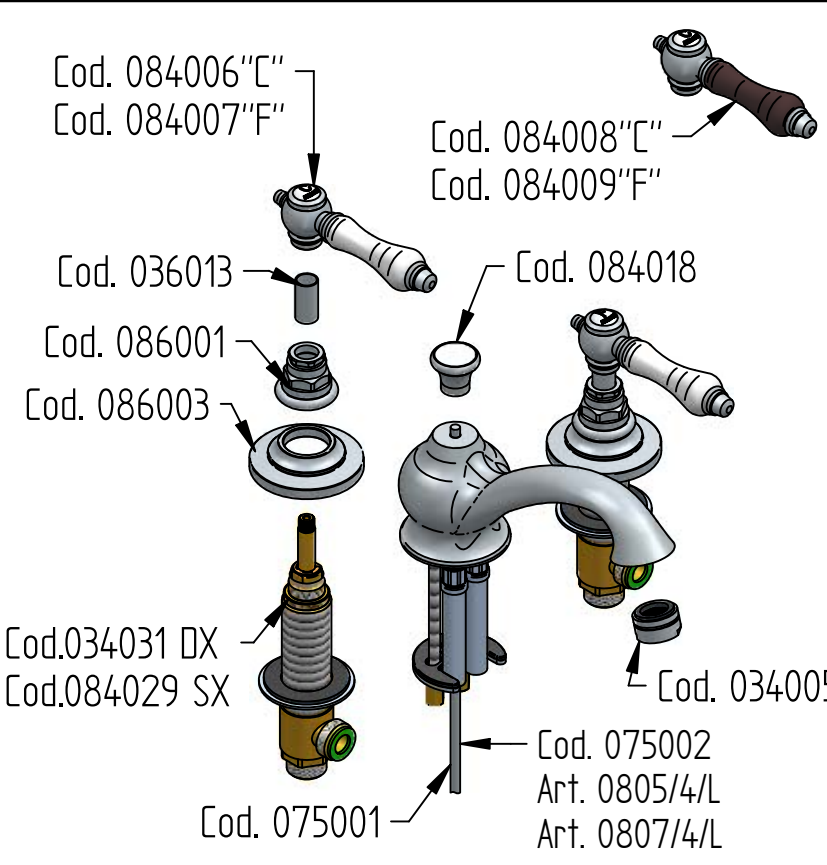

COD. 084018 	COD. 034031 COD. 084029 	COD. 084006 COD. 084007
COD. 086001 	COD. 036013 	COD. 084008 COD. 084009
COD. 075001 COD. 075002 	COD. 034013 Art. 0805/4/L 	COD. 034005 Art. 0805/L
COD. 086003 	COD. 074001 Art. 0807/4/L 	COD. 034008 Art. 0807/7/L

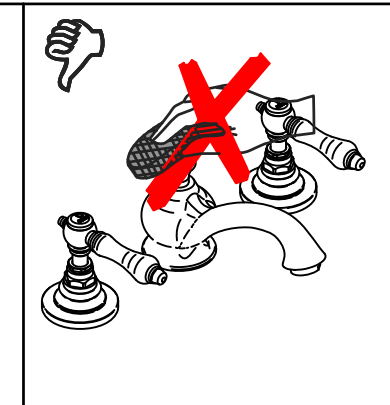
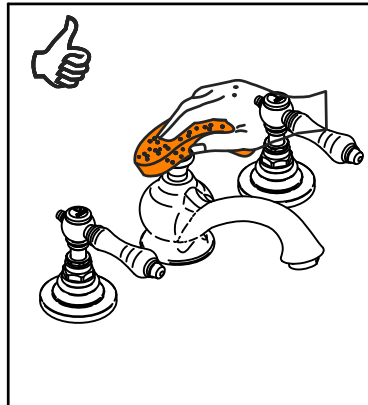
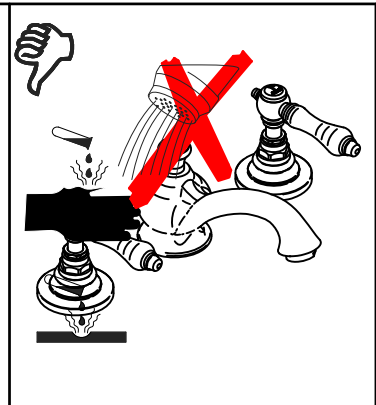
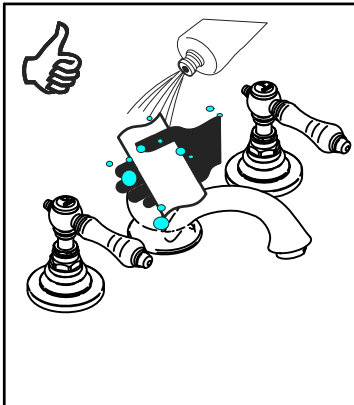

MANUTENZIONE E PULIZIA

Per una corretta manutenzione e pulizia di questo prodotto, raccomandiamo alcuni semplici accorgimenti:

- Utilizzare detergenti neutri, spruzzando il prodotto direttamente su un panno morbido onde evitare infiltrazioni
- Evitare sempre il contatto con prodotti acidi o abrasivi
- Risciacquare bene con abbondante acqua per eliminare eventuali residui ed asciugare sempre con un panno morbido
- Effettuare una pulizia periodica al fine di prevenire le formazioni calcaree

La BELLOSTA CARLO & C. non è RESPONSABILE di danni derivati dall'utilizzo di prodotti impropri per la pulizia.

MAINTENANCE AND CLEANING

For a proper maintenance and cleaning, we recommend the following:

- Use neutral detergents, avoiding to spray directly on taps to avoid residual infiltration
- Avoid contact with acid or abrasive products
- Rinse with water and always dry with a clean cloth to avoid residue of detergent
- Perform a periodic cleaning to prevent limestone deposits

BELLOSTA CARLO & C. cannot be held responsible for damages due to an improper use of detergents

