

LISTINO PREZZI

PRICE LIST

PLISSET | DIAMOND



rubinetti d'autore made in Italy

Cura, attenzione, tecniche d'avanguardia, armonia,
stile ed esperienza, sono gli ingredienti
delle collezioni d'autore Bellosta Rubinetterie

Grazie per la fiducia

Care, attention, avantgarde technique, harmony,
style and experience are the ingredients
of the Bellosta Rubinetterie collections

Thanks for the trust

Bellosta

BRIGA | MILANO | ROMA

listino prezzi 82.2022

plisset **2/19**

diamond **20/37**

Per informazioni generali su come consultare il listino, caratteristiche finiture colore, garanzia, condizioni tecnico commerciali e incassi universali, consultare il listino prezzi RUBINETTERIA.

For general information please consult the general price list, finishes, warranty, technical commercial conditions and inner set section, consult the RUBINETTERIA price list.

COLLEZIONI D'AUTORE



manifattura completamente italiana



GOLD collection

INFO TECNICHE	pag.	3 - 5
TABELLA PREZZI FINITURE	pag.	4

INDICE | INDEX

LAVABO	pag.	6
BIDET	pag.	9
DOCCIA INCASSO	pag.	9
DEVIATORI INCASSO	pag.	11
DOCCIA INCASSO TERMOSTATICO	pag.	12
DOCCIA ESTERNO	pag.	15
DOCCIA COMPLEMENTI	pag.	15
SOFFIONI/BRACCI	pag.	15
COMPONI SET DOCCIA	pag.	15
VASCA	pag.	16
BAGNO COMPLEMENTI	pag.	17
RICAMBI	pag.	19

FORATURA DEI PIANI SANITARI

I miscelatori lavabo/bidet monoforo prevedono un foro di diametro 35 mm nel piano sanitario. Le batterie lavabo 3 fori sono dotate di vitone ceramico destro con apertura a 1/4 di giro (90°); l'interasse consigliato è di 110 mm e foratura come da schema sottostante.

DRILLING PLANS HEALTH

The sink / hole bidet mixers provide a hole diameter of 35 mm in the health plan. The sink batteries 3 holes are equipped with ceramic cartridge Right-open 1/4 turn (90°); the recommended distance is 110 mm, drilling as per the diagram below.

MONOFORO >>
ONE HOLE >>



3 FORI >>
3 HOLES >>

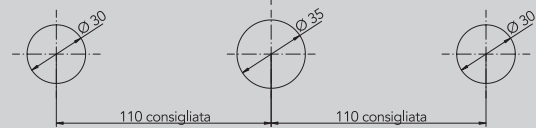

INSTALLAZIONE LAVABI A MURO

Distanza verticale consigliata tra l'uscita dell'acqua ed il bordo superiore del lavabo 8÷10 cm.

WALL-MOUNTED WASHBASIN INSTALLATION

Recommended vertical distance between the water outlet and the upper edge of the sink 8÷10 cm.

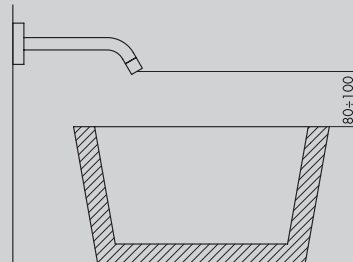

CONSIGLIO TECNICO

Tutti i miscelatori della collezione PLISSET vengono collaudati nel loro funzionamento al momento dell'assemblaggio. Per garantire la durata delle cartucce nel tempo, si consiglia di spurgare bene l'impianto idraulico prima del montaggio (per rimuovere eventuali detriti) e di installare rubinetti sottolavabo con filtro (art. 020). N.B.: Qualora il piano lavabo avesse uno spessore superiore a 4 cm specificare la misura al momento dell'ordine.

TECHNICAL ADVICE

All mixers of the PLISSET collection are perfectly tested. To guarantee the perfect functionality of the cartridge for a long time, we advise to clean the sanitary plant before installing the mixer. Moreover we advise to install angle valve with filter (art. 020).

Attention: If the lavatory top is more than cm 4 thick, please point it out when placing the order.

RISPARMIO IDRICO

Per il risparmio idrico, tutte le bocche lavabo e bidet hanno aeratori con portata del flusso a 5 lt/min, sostituibili con aeratori di portata superiore qualora la bocca di erogazione venga utilizzata per il riempimento vasca.

SAVING WATER

For the saving water, all the basin and bidet spout have aerator with flow rate at 5lt/min, interchangeable with more flow rate aerator, in the case of using spout for fill up the bath.

PROGETTO SU MISURA: RICHIESTE SPECIALI

I tecnici di Bellosta Rubinetterie sono, inoltre, a disposizione di architetti e designers, per offrire un servizio esclusivo: personalizzazioni di elementi in funzione di specifiche richieste estetiche o problematiche legate a vincoli progettuali, verifica della fattibilità attraverso opportuni studi CAD e sviluppo del disegno tecnico del prodotto speciale richiesto.

Per informazioni e richieste PROGETTI SU MISURA:
ufficiotecnico@bellostarubinetterie.com

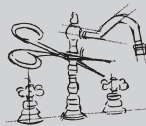

PROGETTO SU MISURA: SPECIAL REQUESTS

Engineers Bellosta Rubinetterie are also available to architects and designers, to offer an exclusive service: customizations of items according to specific aesthetic requirements or issues related to design constraints, verification of the feasibility studies and development through appropriate CAD technical design the required special product. For information and requests "SU MISURA" PROJECTS:
ufficiotecnico@bellostarubinetterie.com

progetto
"sumisura"



PLISSET

PREZZO FINITURE

Calcola il prezzo di listino (IVA esclusa) delle finiture diverse dal cromato, consultando la seguente tabella.

Moltiplicare il **PREZZO LISTINO** per il **COEFFICIENTE MOLTIPLICATORE** della finitura scelta, arrotondando per difetto il prezzo ottenuto (eliminare i centesimi).
ESEMPIO per ordinare art. 4205/S in finitura dorato con maniglia nero opaco: codice 04-4205/S + 67-424001

€ 199,00 (PREZZO LISTINO MIX) x 2,15 (MOLTIPLICATORE) = € ~~427,85~~ 427,00
 € 86,00 (PREZZO LISTINO MANIGLIA) x 1,45 (MOLTIPLICATORE) = € ~~124,70~~ 124,00
 € 427,00 + € 124,00 = € 551,00 PREZZO TOTALE

PRICE FINISHES

Include the list price (excluding VAT) of different finishes from chrome, consulting the following table. **Multiply the PRICE LIST MULTIPLIER COEFFICIENT** of the chosen finish, reducing the price obtained by deleting the centesim. **EXAMPLE** to order art. 4205/S gold finish with matt black handle: code 04-4205/S + 67-424001

€ 199,00 (MIX PRICE LIST) x 2,15 (MULTIPLIER) = € ~~427,85~~ 427,00
 € 86,00 (HANDLE PRICE LIST) x 1,45 (MULTIPLIER) = € ~~124,70~~ 124,00
 € 427,00 + € 124,00 = € 551,00 TOTAL PRICE

COMPOSIZIONE CODICE PER ORDINARE ARTICOLO IN FINITURA

XX - **4205/S**

CODICE FINITURA FINISH CODE CODICE ARTICOLO ITEM NUMBER +

XX - **424001**

CODICE FINITURA FINISH CODE CODICE MANIGLIA HANDLE NUMBER

**MOLTIPLICATORI FINITURE DI SERIE
 STANDARD FINISHES MULTIPLIERS**

COD. CODE	DESCRIZIONE FINITURA FINISH DESCRIPTION	PLISSET	RICAMBI	DOCCIA COMPL.
-----------	---	---------	---------	---------------

01- cromato/chrome **PREZZO LISTINO°**

**MOLTIPLICATORI FINITURE A RICHIESTA
 ON REQUEST FINISHES MULTIPLIERS**

COD. CODE	DESCRIZIONE FINITURA FINISH DESCRIPTION	PLISSET	RICAMBI	DOCCIA COMPL.
02-	cromo/oro/chrome/gold	x 1,50	x 1,70	x 1,50
03-	oro/argento/gold/silver	x 1,65	x 1,85	x 1,75
04-	dorato/gold	x 2,15	x 2,40	x 2,20
05-	bronzo satinato/satin bronze	x 1,65	x 1,85	x 1,75
06-	rame vecchio/old copper	x 1,65	x 1,85	x 1,75
07-	vecchio argento/old silver	x 1,65	x 1,85	x 1,75
08-	canna di fucile/gun barrel	x 2,15	x 2,40	x 2,20
10-	verderame/verdigris	x 2,15	x 2,40	x 2,20
11-	nero antracite/anthracite black	x 2,15	x 2,40	x 2,20
12-	ottone lucido/polished brass	x 1,50	x 1,70	x 1,50
13-	ottone naturale/natural brass	x 1,30	x 1,30	x 1,30
14-	bianco lucido/glossy white	x 1,45	x 1,50	x 1,45
19-	nero lucido/glossy black	x 1,45	x 1,50	x 1,45
28-	nickel satinato/satin nickel	x 1,65	x 1,85	x 1,75
30-	nickel lucido/polished nickel	x 1,65	x 1,85	x 1,75
33-	cromo satinato/satin chrome	x 1,65	x 1,85	x 1,75
34-	cromo spazzolato/brushing chrome	x 1,70	x 1,95	x 1,80
35-	nickel spazzolato/brushing nickel	x 1,65	x 1,85	x 1,75
56-	avorio/ivory	x 1,65	x 1,85	x 1,75
57-	azzurro/light blue	x 1,65	x 1,85	x 1,75
58-	verdino/light green	x 1,65	x 1,85	x 1,75

°PREZZO DI LISTINO PRICE LIST
 RICAMBI SPARE PARTS

* N.R. = NON REALIZZABILE NOT MADE
 DOCCIA COMPLEMENTI SHOWER COMPLEMENTS

NOTE:

Flex art. 915003 realizzabile nelle seguenti finiture:
 01,03,04,05,06,07,12,13,19,28,30,33,34,35,66,67,68,69,71,72,75,B2,B3,B4.
 Per altre finiture ordinare art. 655016.

**MOLTIPLICATORI FINITURE A RICHIESTA
 ON REQUEST FINISHES MULTIPLIERS**

COD. CODE	DESCRIZIONE FINITURA FINISH DESCRIPTION	PLISSET	RICAMBI	DOCCIA COMPL.
-----------	---	---------	---------	---------------

59-	marrone/brown	x 1,65	x 1,85	x 1,75
60-	arancio/orange	x 1,65	x 1,85	x 1,75
61-	rosso/red	x 1,65	x 1,85	x 1,75
66-	bianco opaco/mat white	x 1,45	x 1,50	x 1,45
67-	nero opaco/matt black	x 1,45	x 1,50	x 1,45
68-	rame opaco/matt copper	x 1,65	x 1,85	x 1,75
69-	argento opaco/matt silver	x 1,65	x 1,85	x 1,75
71-	oro opaco/matt gold	x 2,15	x 2,40	x 2,20
72-	bronzo opaco/matt bronze	x 1,65	x 1,85	x 1,75
75-	dorato spazzolato/brushing gold	x 2,30	x 2,55	x 2,40
87-	oro rosa/pink gold	x 2,30	x 2,55	x 2,40
88-	ottone sisal/sisal brass	x 1,50	x 1,70	x 1,50
89-	industrial	x 2,15	x 2,40	x 2,20
92-	pomice opaco/matt pumice	x 1,85	x 2,00	x 1,90
93-	arenaria opaco/matt sandstone	x 1,85	x 2,00	x 1,90
94-	tuscany spazzolato/brushing tuscany	x 1,85	x 2,00	x 1,90
95-	rame acidato/etched copper	x 2,15	x 2,40	x 2,20
96-	cemento opaco/matt cement	x 1,85	x 2,00	x 1,90
A1-	brina opaco/matt frost	x 1,85	x 2,00	x 1,90
A2-	tuscany cerato/oilskin tuscany	x 1,85	x 2,00	x 1,90
A3-	ottone acidato/etched brass	x 2,15	x 2,40	x 2,20
A4-	basalto opaco/matt basalt	x 1,85	x 2,00	x 1,90
B2-	black gun metal PVD	RICH.	RICH.	RICH.
B3-	nickel PVD	RICH.	RICH.	RICH.
B4-	matt gold PVD	RICH.	RICH.	RICH.

RICH. = PREZZO A RICHIESTA ON REQUEST PRICE

NOTE:

Flex art. 915003 is available in the following finishes:
 01,03,04,05,06,07,12,13,19,28,30,33,34,35,66,67,68,69,71,72,75,B2,B3,B4.
 For other colors order the art. 655016.

**SCHEMA FUNZIONAMENTO DEVIATORI INCASSO 2/3/4 USCITE:
4203/2/1/E, 4203/3/1/E, 4203/4/1/E**

Questi deviatori non hanno funzione di chiusura. Ruotando verso destra o sinistra si attivano le uscite. Tra 2 uscite adiacenti durante la rotazione diminuisce la portata dell'uscita iniziale ed incrementa quella della successiva. In posizione intermedia sono entrambe attive a pari portata.

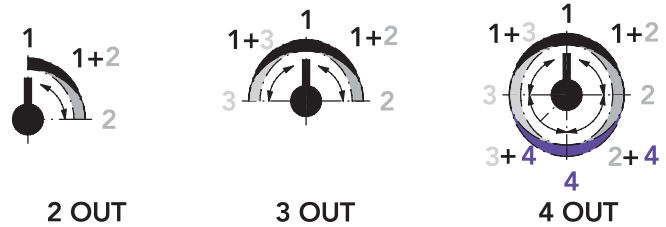

**SCHEME OPERATING SWITCHES FLUSH OUTPUT 2/3/4:
4203/2/1/E, 4203/3/1/E, 4203/4/1/E**

These diverters have not closing function. By turning to the right or left activates the outputs. Between two adjacent outputs during the rotation decreases the initial output flow and increases that of the next. In position intermediate are both active at the same flow rate.

**SCHEMA FUNZIONAMENTO MISCELATORI TERMOSTATICI 2/3/4 USCITE:
4212/2/P/E, 4212/3/P/E, 4212/4/P/E**

Leva in posizione ore 12 = deviatore chiuso. Ruotando verso destra o sinistra si attivano le diverse uscite. Partendo dalla posizione di STOP, durante la rotazione la portata dell'acqua si incrementa verso la posizione successiva. Tra 2 uscite adiacenti durante la rotazione diminuisce la portata dell'uscita iniziale ed incrementa quella della successiva. In posizione intermedia sono entrambe attive a pari portata.

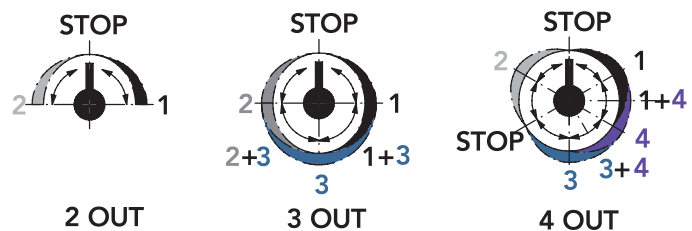

**SCHEME OPERATING THERMOSTATIC MIXER 2/3/4 OUT:
4212/2/P/E, 4212/3/P/E, 4212/4/P/E**

Lever to the 12 o'clock position = switch closed. Turning left or right. They activate different outputs. Starting from the STOP position, while rotation of the water flow rate between two adjacent outputs is increased towards the next position. Between two adjacent outputs during the rotation decreases the initial output flow and increases that of the next. In position intermediate are both active at the same flow rate.

SCHEMA FUNZIONAMENTO MISCELATORI INCASSO C/DEVIATORE MECCANICO 2/3 USCITE: 1200/2/42/E, 1200/3/42/E

Questi deviatori non hanno funzione di chiusura. Ruotando verso destra o sinistra si attivano le uscite. Tra 2 uscite adiacenti durante la rotazione diminuisce la portata dell'uscita iniziale ed incrementa quella della successiva. In posizione intermedia sono entrambe attive a pari portata.

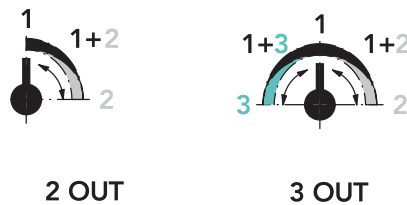

**SCHEME OPERATING BUILT-IN MIXER WITH MECHANICAL DIVERTER 2/3 OUT:
1200/2/42/E, 1200/3/42/E**

These diverters have not closing function. By turning to the right or left activates the outputs. Between two adjacent outputs during the rotation decreases the initial output flow and increases that of the next. In position intermediate are both active at the same flow rate.

SCHEMA FUNZIONAMENTO MISCELATORI TERMOSTATICI 2/3/4 USCITE CON INCASSI 125002 E 125003: 1212/2/P42/E, 1212/3/P42/E

DEVIATORE A 2 USCITE: leva in posizione ore 12 = deviatore chiuso. Ruotando verso destra o sinistra si attivano le uscite. Partendo dalla posizione di STOP, durante la rotazione si incrementa la portata dell'acqua.

DEVIATORE A 3 USCITE: leva in posizione ore 12 = deviatore chiuso. Ruotando verso destra o sinistra si attivano le uscite, tra un'uscita e la successiva vi è sempre una posizione di STOP. Partendo dalla posizione di STOP, durante la rotazione si incrementa la portata dell'acqua fino al massimo in posizione di uscita, continuando la rotazione decresce la portata fino al raggiungimento della successiva posizione di STOP.

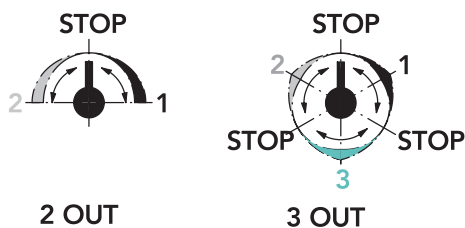

SCHEME OPERATING THERMOSTATIC MIXER 2/3/4 OUT WITH INNER SET 125002 AND 125003: 1212/2/P42/E, 1212/3/P42/E

2-OUT DIVERTER: position lever at 12 o'clock = closed diverter. Turning to the right or left activates the outputs. Starting from the STOP position, the water flow increases during rotation.

3-OUT DIVERTER: position lever at 12 o'clock = closed diverter. Turning to the right or left activates the outputs, between one output and the next there is always a STOP position. Starting from the STOP position, while the rotation increases the water flow to the maximum in the output position, continuing rotation decreases the flow until reaching the next STOP position.

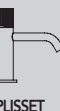

PLISSET

4205/S + 424001

[mix] [maniglia]

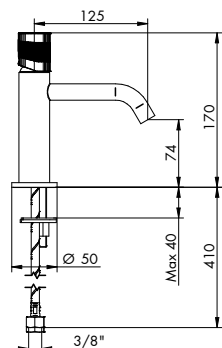

MISCELATORE LAVABO MONOFORO

BASIN MIXER

- > cartuccia tradizionale
- > interasse bocca 125
- > limitatore di portata 5 l/min 3bar
- > flessibili di alimentazione
- > senza scarico
- > abbinare a rubinetto sottolavabo con filtro (art. 020)



0136/U p. 880
listino Rubinetteria



0133/L p. 879
listino Rubinetteria

CROMATO / MAN. CROMATO	
01-4205/S	€ 199,00
01-424001	€ 86,00

PREZZO TOTALE € 285,00

CROMATO / MANIGLIA IN ALTRA FINITURA	
01-4205/S	€ 199,00
XX-424001	€ 86,00 x M*

ALTRE FINITURE	
XX-4205/S	€ 199,00 x M*
XX-424001	€ 86,00 x M*



454038



455039

4205/P/S + 424001

[mix] [maniglia]

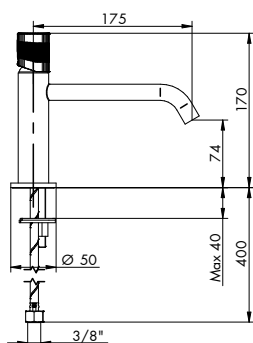

MISCELATORE LAVABO MONOFORO BOCCA PROLUNGATA

BASIN MIXER EXTENDED SPOUT

- > cartuccia tradizionale
- > interasse bocca 175
- > limitatore di portata 5 l/min 3bar
- > flessibili di alimentazione
- > senza scarico
- > abbinare a rubinetto sottolavabo con filtro (art. 020)



0136/U p. 880
listino Rubinetteria



0133/L p. 879
listino Rubinetteria

CROMATO / MAN. CROMATO	
01-4205/P/S	€ 212,00
01-424001	€ 86,00

PREZZO TOTALE € 298,00

CROMATO / MANIGLIA IN ALTRA FINITURA	
01-4205/P/S	€ 212,00
XX-424001	€ 86,00 x M*

ALTRE FINITURE	
XX-4205/P/S	€ 212,00 x M*
XX-424001	€ 86,00 x M*



454038



455039

474015 | 474016 | 474017



PROLUNGHE MISCELATORE LAVABO

EXTENSIONS FOR BASIN

- > diametro 34 mm
- > altezza 50 mm, 100 mm, 150 mm

CROMATO		
01-474015	50 mm	€ 61,00
01-474016	100 mm	€ 78,00
01-474017	150 mm	€ 130,00

ALTRE FINITURE		
XX-474015	50 mm	€ 61,00 x M*
XX-474016	100 mm	€ 78,00 x M*
XX-474017	150 mm	€ 130,00 x M*

4205/1 + 424001

[mix] [maniglia]

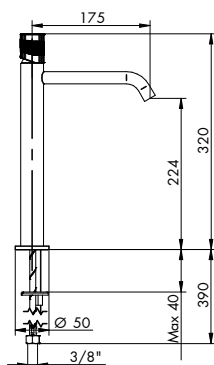

MISCELATORE LAVABO MONOFORO ALTO BOCCA PROLUNGATA

HIGHER BASIN MIXER EXTENDED SPOUT

- > cartuccia tradizionale
- > interasse bocca 175
- > limitatore di portata 5 l/min 3bar
- > flessibili di alimentazione
- > senza scarico
- > abbinare a rubinetto sottolavabo con filtro (art. 020)



0136/U p. 880
listino Rubinetteria



0133/L p. 879
listino Rubinetteria

CROMATO / MAN. CROMATO	
01-4205/1	€ 324,00
01-424001	€ 86,00

PREZZO TOTALE € 410,00

CROMATO / MANIGLIA IN ALTRA FINITURA	
01-4205/1	€ 324,00
XX-424001	€ 86,00 x M*

ALTRE FINITURE	
XX-4205/1	€ 324,00 x M*
XX-424001	€ 86,00 x M*



454038



455039

4205/3/B/E + 424002 + 894001

[parte esterna] [maniglia] [parte incasso]

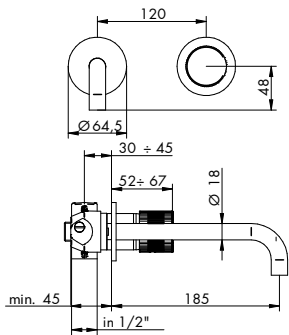
**MISCELATORE LAVABO DA PARETE BOCCA PROLUNGATA**
WALL BASIN EXTENDED SPOUT MIXER

- > cartuccia tradizionale
- > interasse bocca 185
- > limitatore di portata 5l/min 3bar
- > ingressi da 1/2"
- > senza scarico
- > rosoni separati

0136/U p. 880
listino Rubinetteria0133/L p. 879
listino Rubinetteria**P. EST. - CROMATO / MAN. CROMATO**

01-4205/3/B/E	€ 144,00
01-424002	€ 86,00

PARTE INCASSO

01-894001	info pag. 30	€ 127,00
-----------	--------------	----------

PREZZO TOTALE € 357,00**P. EST. - CROMATO / MAN. IN ALTRA FINITURA**

01-4205/3/B/E	€ 144,00
XX-424002	€ 86,00 x M*

PARTI ESTERNE - ALTRE FINITURE

XX-4205/3/B/E	€ 144,00 x M*
XX-424002	€ 86,00 x M*



454038



025002

PER INSTALLAZIONI SU PARETI IN CARTONGESSO VERIFICARE LE DIMENSIONI DEL PANNELLO E ORDINARE LA NECESSARIA PROLUNGA
FOR INSTALLATIONS ON DRYWALL, CHECK THE DIMENSIONS OF THE PANEL AND ORDER THE NECESSARY EXTENSION

4205/3/C/E + 424002 + 894001

[parte esterna] [maniglia] [parte incasso]

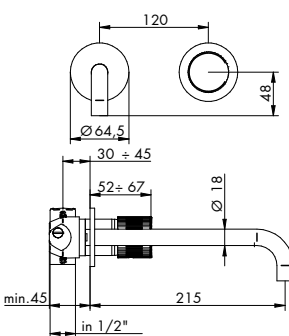
**MISCELATORE LAVABO DA PARETE BOCCA EXTRA PROLUNGATA**
WALL BASIN EXTRA EXTENDED SPOUT MIXER

- > cartuccia tradizionale
- > interasse bocca 215
- > limitatore di portata 5l/min 3bar
- > ingressi da 1/2"
- > senza scarico
- > rosoni separati

0136/U p. 880
listino Rubinetteria0133/L p. 879
listino Rubinetteria**P. EST. - CROMATO / MAN. CROMATO**

01-4205/3/C/E	€ 159,00
01-424002	€ 86,00

PARTE INCASSO

01-894001	info pag. 30	€ 127,00
-----------	--------------	----------

PREZZO TOTALE € 372,00**P. EST. - CROMATO / MAN. IN ALTRA FINITURA**

01-4205/3/C/E	€ 159,00
XX-424002	€ 86,00 x M*

PARTI ESTERNE - ALTRE FINITURE

XX-4205/3/C/E	€ 159,00 x M*
XX-424002	€ 86,00 x M*



454038



025002

PER INSTALLAZIONI SU PARETI IN CARTONGESSO VERIFICARE LE DIMENSIONI DEL PANNELLO E ORDINARE LA NECESSARIA PROLUNGA
FOR INSTALLATIONS ON DRYWALL, CHECK THE DIMENSIONS OF THE PANEL AND ORDER THE NECESSARY EXTENSION

4205/3/2/E + 424002 + 894001

[parte esterna] [maniglia] [parte incasso]

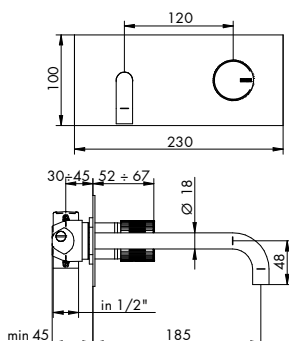
**MISCELATORE LAVABO DA PARETE BOCCA PROLUNGATA SU PIASTRA**
WALL BASIN MIXER EXTENDED SPOUT ON PLATE

- > cartuccia tradizionale
- > interasse bocca 185
- > limitatore di portata 5l/min 3bar
- > ingressi da 1/2"
- > senza scarico
- > piastra unica rettangolare

0136/U p. 880
listino Rubinetteria0133/L p. 879
listino Rubinetteria**P. EST. - CROMATO / MAN. CROMATO**

01-4205/3/2/E	€ 231,00
01-424002	€ 86,00

PARTE INCASSO

01-894001	info pag. 30	€ 127,00
-----------	--------------	----------

PREZZO TOTALE € 444,00**P. EST. - CROMATO / MAN. IN ALTRA FINITURA**

01-4205/3/2/E	€ 231,00
XX-424002	€ 86,00 x M*

PARTI ESTERNE - ALTRE FINITURE

XX-4205/3/2/E	€ 231,00 x M*
XX-424002	€ 86,00 x M*



454038



025002

PER INSTALLAZIONI SU PARETI IN CARTONGESSO VERIFICARE LE DIMENSIONI DEL PANNELLO E ORDINARE LA NECESSARIA PROLUNGA
FOR INSTALLATIONS ON DRYWALL, CHECK THE DIMENSIONS OF THE PANEL AND ORDER THE NECESSARY EXTENSION

4205/3/3/E + 424002 + 894001

[parte esterna] [maniglia] [parte incasso]

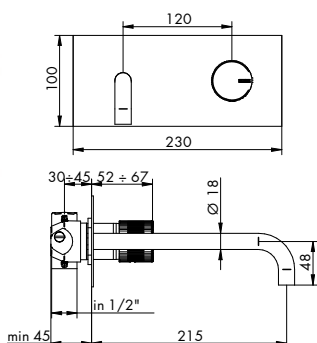
**MISCELATORE LAVABO DA PARETE BOCCA EXTRA PROLUNGATA SU PIASTRA**
WALL BASIN MIXER EXTRA EXTENDED SPOUT ON PLATE

- > cartuccia tradizionale
- > interasse bocca 215
- > limitatore di portata 5l/min 3bar
- > ingressi da 1/2"
- > senza scarico
- > piastra unica rettangolare

0136/U p. 880
listino Rubinetteria0133/L p. 879
listino Rubinetteria**P. EST. - CROMATO / MAN. CROMATO**

01-4205/3/3/E	€ 246,00
01-424002	€ 86,00

PARTE INCASSO

01-894001	info pag. 30	€ 127,00
-----------	--------------	----------

PREZZO TOTALE € 459,00**P. EST. - CROMATO / MAN. IN ALTRA FINITURA**

01-4205/3/3/E	€ 246,00
XX-424002	€ 86,00 x M*

PARTI ESTERNE - ALTRE FINITURE

XX-4205/3/3/E	€ 246,00 x M*
XX-424002	€ 86,00 x M*



454038



025002

PER INSTALLAZIONI SU PARETI IN CARTONGESSO VERIFICARE LE DIMENSIONI DEL PANNELLO E ORDINARE LA NECESSARIA PROLUNGA
FOR INSTALLATIONS ON DRYWALL, CHECK THE DIMENSIONS OF THE PANEL AND ORDER THE NECESSARY EXTENSION

4205/R/A + 424001

[mix] [maniglia]

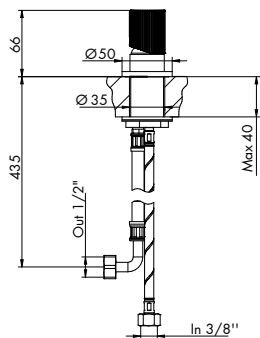

MISCELATORE REMOTO
REMOTE MIXER

- > cartuccia tradizionale
- > flessibili di alimentazione
- > senza scarico



0136/U p. 880
listino Rubinetteria



0133/L p. 879
listino Rubinetteria

CROMATO / MAN. CROMATO	
01-4205/R/A	€ 236,00
01-424001	€ 86,00
PREZZO TOTALE	€ 322,00

CROMATO / MANIGLIA IN ALTRA FINITURA	
01-4205/R/A	€ 236,00
XX-424001	€ 86,00 x M*

ALTRE FINITURE	
XX-4205/R/A	€ 236,00 x M*
XX-424001	€ 86,00 x M*



455039

4205/R/B/E + 424002 + 104033

[parte esterna] [maniglia] [parte incasso]

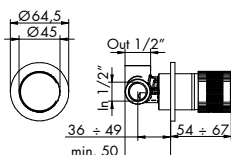

MISCELATORE INCASSO REMOTO BUILT-IN
REMOTE MIXER

- > cartuccia tradizionale
- > ingressi da 1/2"
- > uscita superiore
- > senza scarico
- > utilizzabile anche come incasso doccia



0136/U p. 880
listino Rubinetteria



0133/L p. 879
listino Rubinetteria

P. EST. - CROMATO / MAN. CROMATO	
01-4205/R/B/E	€ 74,00
01-424002	€ 86,00

P. EST. - CROMATO / MAN. IN ALTRA FINITURA	
01-4205/R/B/E	€ 74,00
XX-424002	€ 86,00 x M*

PARTE INCASSO	
01-104033	info pag. 27 € 138,00
PREZZO TOTALE	€ 258,00

PARTI ESTERNE - ALTRE FINITURE	
XX-4205/R/B/E	€ 74,00 x M*
XX-424002	€ 86,00 x M*



025002



PER INSTALLAZIONI SU PARETI IN CARTONGESSO VERIFICARE LE DIMENSIONI DEL PANNELLO E ORDINARE LA NECESSARIA PROLUNGA
FOR INSTALLATIONS ON DRYWALL, CHECK THE DIMENSIONS OF THE PANEL AND ORDER THE NECESSARY EXTENSION

104009 | 104010 | 104011



KIT PROLUNGA MIX INCASSO
BUILT-IN MIXER EXTENSION KIT

- > lunghezza 2 cm, 3 cm, 4 cm
- > kit fondello prolunga cartuccia miscelatore + bicchiere esterno sostitutivo in finitura
- > per art. 4205/R/B/E, 4205/3/3/E, 4205/3/2/E, 4205/3/C/E, 4205/3/B/E

CROMATO		
01-104009	2 cm	€ 134,00
01-104010	3 cm	€ 152,00
01-104011	4 cm	€ 183,00

ALTRE FINITURE		
XX-104009	2 cm	€ 134,00 x M*
XX-104010	3 cm	€ 152,00 x M*
XX-104011	4 cm	€ 183,00 x M*

* MOLTIPLICATORE RICAMBI
* MULTIPLIER "RICAMBI"

464008 | 464014

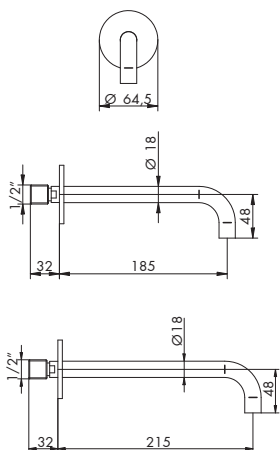

BOCCA LAVABO DA PARETE
WALL WASH SPOUT L 185

- > interasse bocca 185 / 215
- > limitatore di portata 5 l/min 3 bar
- > attacco da 1/2"
- > rosone tondo



0136/U p. 880
listino Rubinetteria



0133/L p. 879
listino Rubinetteria

CROMATO		
01-464008	185 mm	€ 110,00
01-464014	215 mm	€ 129,00

ALTRE FINITURE		
XX-464008	185 mm	€ 110,00 x M*
XX-464014	215 mm	€ 129,00 x M*



454038

4605/1/C

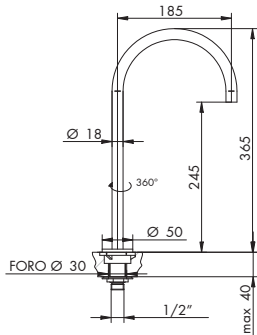
BOCCA MONOFORO GIREVOLE
SWINGING WASH SPOUT

- > interasse bocca 185
- > bocca girevole 360°
- > limitatore di portata 5 l/min 3 bar
- > attacco da 1/2"

SCARICO LAVABO
BASIN WASTE0136/U p. 880
listino RubinetteriaSIFONE
SIPHON0133/L p. 879
listino Rubinetteria

CROMATO

01-4605/1/C € 216,00

ALTRE FINITURE

XX-4605/1/C € 216,00 x M*

AERATORE C/CHIAVE
AERATOR W/KEY

454038

4207/S + 424001

[mix] [maniglia]

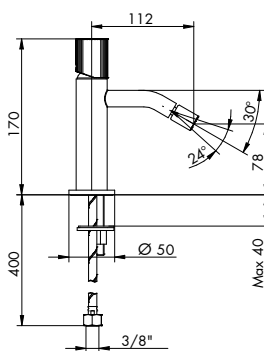
MISCELATORE BIDET MONOFORO
BIDET MIXER

- > cartuccia tradizionale
- > interasse bocca 112
- > aeratore snodato
- > limitatore di portata 5 l/min 3 Bar
- > flessibili di alimentazione
- > senza scarico

SCARICO BIDET
BIDET WASTE0136/U p. 880
listino RubinetteriaSIFONE
SIPHON011/B p. 887
listino Rubinetteria

CROMATO / MAN. CROMATO

01-4207/S € 199,00

01-424001 € 86,00

PREZZO TOTALE € 285,00

CROMATO / MANIGLIA IN ALTRA FINITURA

01-4207/S € 199,00

XX-424001 € 86,00 x M*

ALTRE FINITURE

XX-4207/S € 199,00 x M*

XX-424001 € 86,00 x M*

AERATORE C/CHIAVE
AERATOR W/KEY

454038

CARTUCCIA
CARTRIDGE

455039

464003

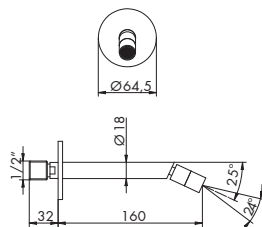
BOCCA BIDET DA PARETE
WALL BIDET SPOUT

- > interasse bocca 160
- > aeratore snodato
- > attacco da 1/2"
- > rosone tondo

SCARICO BIDET
BIDET WASTE0136/U p. 880
listino RubinetteriaSIFONE
SIPHON011/B p. 887
listino Rubinetteria

CROMATO

01-464003 € 157,00

ALTRE FINITURE

XX-464003 € 157,00 x M*

SNODINO AERATORE
JOINT WITH AERATOR

014076

01- cromato / XX- finitura

4221/E + 424002 + 104018

[parte esterna] [maniglia] [parte incasso]

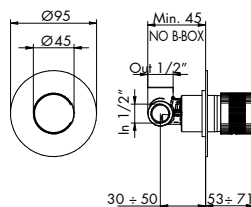
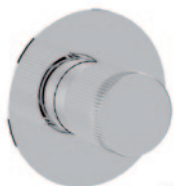
MISCELATORE INCASSO
BUILT-IN MIXER

- > cartuccia tradizionale
- > ingressi da 1/2"
- > uscita superiore
- > incasso con B-BOX

PILETTA DOCCIA
SHOWER WASTE8816/E + 775025
p. 888 listino Rubinetteria

P. EST. - CROMATO / MAN. CROMATO

01-4221/E € 69,00

01-424002 € 86,00

PARTE INCASSO

01-104018 info pag. 32 € 138,00

PREZZO TOTALE € 293,00

P. EST. - CROMATO / MAN. IN ALTRA FINITURA

01-4221/E € 69,00

XX-424002 € 86,00 x M*

PARTI ESTERNE - ALTRE FINITURE

XX-4221/E € 69,00 x M*

XX-424002 € 86,00 x M*

INCASSO
UNIVERSALE
CON B-BOXPER INSTALLAZIONI SU PARETI IN CARTONGESSO VERIFICARE LE DIMENSIONI DEL PANNELLO E ORDINARE LA NECESSARIA PROLUNGA
FOR INSTALLATIONS ON DRYWALL, CHECK THE DIMENSIONS OF THE PANEL AND ORDER THE NECESSARY EXTENSIONCARTUCCIA
CARTRIDGE

025002

104009 | 104010 | 104011

KIT PROLUNGA MIX INCASSO
BUILT-IN MIXER EXTENSION KIT

- > lunghezza 2 cm, 3 cm, 4 cm
- > kit fondello prolunga cartuccia miscelatore + bicchiere esterno sostitutivo in finitura
- > per art.: 4221/E



CROMATO

01-104009	2 cm	€ 134,00
01-104010	3 cm	€ 152,00
01-104011	4 cm	€ 183,00

ALTRE FINITURE

XX-104009	2 cm	€ 134,00 x M*
XX-104010	3 cm	€ 152,00 x M*
XX-104011	4 cm	€ 183,00 x M*

* MOLTIPLICATORE RICAMBI
* MULTIPLIER "RICAMBI"

4200/E + 424002 + 104002

[parte esterna] [maniglia] [parte incasso]

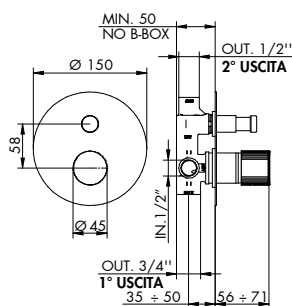

INCASSO
UNIVERSALE
CON B-BOX

MISCELATORE INCASSO C/DEVIATORE AUTOMATICO 2 USCITE
BUILT-IN MIXER WITH AUTOMATIC DIVERTER 2 OUT

- > cartuccia tradizionale
- > deviatore a pressione 2 uscite c/ritorno automatico e blocco meccanico basse pressioni
- > attacchi da 1/2"
- > uscita principale inferiore da 3/4"
- > incasso con B-BOX



8816/E + 775025
p. 888 listino Rubinetteria

P. EST. - CROMATO / MAN. CROMATO

01-4200/E	€ 80,00
01-424002	€ 86,00

P. EST. - CROMATO / MAN. IN ALTRA FINITURA

01-4200/E	€ 80,00
XX-424002	€ 86,00 x M*

PARTE INCASSO

01-104002	info pag. 33	€ 281,00
-----------	--------------	----------

PARTI ESTERNE - ALTRE FINITURE

XX-4200/E	€ 80,00 x M*
XX-424002	€ 86,00 x M*

PREZZO TOTALE € 447,00



105029



025002

PER INSTALLAZIONI SU PARETI IN CARTONGESSO VERIFICARE LE DIMENSIONI DEL PANNELLO E ORDINARE LA NECESSARIA PROLUNGA
FOR INSTALLATIONS ON DRYWALL, CHECK THE DIMENSIONS OF THE PANEL AND ORDER THE NECESSARY EXTENSION

4200/1/P/E + 424002 + 724027

[parte esterna] [maniglia] [parte incasso]

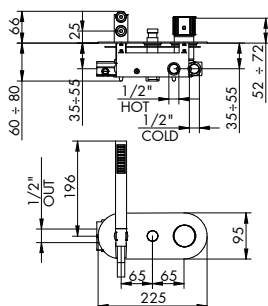
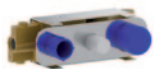

INCASSO
UNIVERSALE

MISCELATORE INCASSO C/DEVIATORE AUTOMATICO E DOCCETTA
BUILT-IN MIXER WITH AUTOMATIC DIVERTER AND HAND SHOWER

- > cartuccia tradizionale
- > deviatore a pressione 2 uscite c/ritorno automatico e blocco meccanico basse pressioni
- > attacchi da 1/2" > flessibile PVC 150 cm
- > uscita principale fianco sinistro
- > doccetta monogetto cilindrica in ABS c/anticalcare, per finiture diverse da cromo doccetta in metallo



8816/E + 775025
p. 888 listino Rubinetteria

P. EST. - CROMATO / MAN. CROMATO

01-4200/1/P/E	€ 245,00
01-424002	€ 86,00

P. EST. - CROMATO / MAN. IN ALTRA FINITURA

01-4200/1/P/E	€ 245,00
XX-424002	€ 86,00 x M*

PARTE INCASSO

01-724027	info pag. 35	€ 616,00
-----------	--------------	----------

PARTI ESTERNE - ALTRE FINITURE

XX-4200/1/P/E	€ 245,00 x M*
XX-424002	€ 86,00 x M*

PREZZO TOTALE € 947,00



724030



025002

PER INSTALLAZIONI SU PARETI IN CARTONGESSO VERIFICARE LE DIMENSIONI DEL PANNELLO E ORDINARE LA NECESSARIA PROLUNGA
FOR INSTALLATIONS ON DRYWALL, CHECK THE DIMENSIONS OF THE PANEL AND ORDER THE NECESSARY EXTENSION

104006 | 104007 | 104008

KIT PROLUNGA MIX INCASSO CON DEVIAZIONE
BUILT-IN MIXER EXTENSION KIT WITH DIVERTER

- > lunghezza 2 cm, 3 cm, 4 cm
- > kit fondello prolunga cartuccia miscelatore e albero deviatore + bicchieri esterni sostitutivi in finitura
- > per art.: 4200/E, 4200/1/P/E



CROMATO

01-104006	2 cm	€ 171,00
01-104007	3 cm	€ 193,00
01-104008	4 cm	€ 224,00

ALTRE FINITURE

XX-104006	2 cm	€ 171,00 x M*
XX-104007	3 cm	€ 193,00 x M*
XX-104008	4 cm	€ 224,00 x M*

* MOLTIPLICATORE RICAMBI
* MULTIPLIER "RICAMBI"

1200/2/42/E + 424009+ 124034

[parte esterna] [maniglia] [parte incasso]

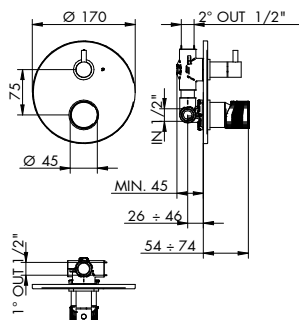
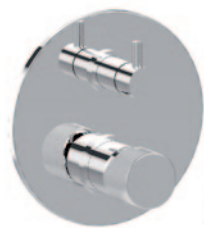

**NON COMPATIBILE
CON INCASSO
UNIVERSALE**

**MISCELATORE INCASSO C/DEVIATORE MECCANICO 2 USCITE**
BUILT-IN MIXER WITH MECHANICAL DIVERTER 2 OUT

- > cartuccia tradizionale
- > non compatibile con incasso universale 104002
- > incasso senza B-BOX
- > deviatore a dischi ceramici 2 uscite senza chiusura
- > ingressi laterali da 1/2" > interasse 75 mm
- > uscite laterale e superiore da 1/2" > incasso regolabile min 45



8816/E + 775025
p. 888 listino Rubinetteria

P. EST. - CROMATO / MAN. CROMATO	
01-1200/2/42/E	€ 131,00
01-424009	€ 104,00

P. EST. - CROMATO / MAN. IN ALTRA FINITURA	
01-1200/2/42/E	€ 131,00
XX-424009	€ 104,00 x M*

PARTE INCASSO	
01-124034	info pag. 34 € 222,00
PREZZO TOTALE	€ 457,00

PARTI ESTERNE - ALTRE FINITURE	
XX-1200/2/42/E	€ 131,00 x M*
XX-424009	€ 104,00 x M*

PER INSTALLAZIONI SU PARETI IN CARTONGESSO VERIFICARE LE DIMENSIONI DEL PANNELLO E ORDINARE LA NECESSARIA PROLUNGA
FOR INSTALLATIONS ON DRYWALL, CHECK THE DIMENSIONS OF THE PANEL AND ORDER THE NECESSARY EXTENSION



635010



025002

1200/3/42/E + 424009 + 124035

[parte esterna] [maniglia] [parte incasso]

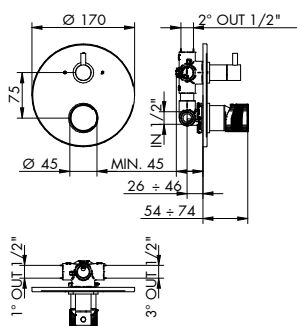
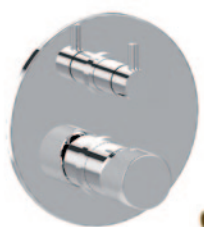

**NON COMPATIBILE
CON INCASSO
UNIVERSALE**

**MISCELATORE INCASSO C/DEVIATORE MECCANICO 3 USCITE**
BUILT-IN MIXER WITH MECHANICAL DIVERTER 3 OUT

- > cartuccia tradizionale
- > non compatibile con incasso universale 104002
- > incasso senza B-BOX
- > deviatore a dischi ceramici 3 uscite senza chiusura
- > ingressi laterali da 1/2" > interasse 75 mm
- > uscite laterale e superiore da 1/2" > incasso regolabile min 45



8816/E + 775025
p. 888 listino Rubinetteria

P. EST. - CROMATO / MAN. CROMATO	
01-1200/3/42/E	€ 131,00
01-424009	€ 104,00

P. EST. - CROMATO / MAN. IN ALTRA FINITURA	
01-1200/3/42/E	€ 131,00
XX-424009	€ 104,00 x M*

PARTE INCASSO	
01-124035	info pag. 34 € 241,00
PREZZO TOTALE	€ 476,00

PARTI ESTERNE - ALTRE FINITURE	
XX-1200/3/42/E	€ 131,00 x M*
XX-424009	€ 104,00 x M*

PER INSTALLAZIONI SU PARETI IN CARTONGESSO VERIFICARE LE DIMENSIONI DEL PANNELLO E ORDINARE LA NECESSARIA PROLUNGA
FOR INSTALLATIONS ON DRYWALL, CHECK THE DIMENSIONS OF THE PANEL AND ORDER THE NECESSARY EXTENSION



635011



025002

125098 | 125104**KIT PROLUNGA**
EXTENSION KIT

- > lunghezza 3 cm
- > art. 125098: kit fondello prolunga cartuccia miscelatore + prolunga bicchiere esterno in finitura
- > art. 125104: kit prolunga deviatore meccanico
- > per art.: 1200/2/42/E, 1200/3/42/E



CROMATO	
01-125098	€ 110,00
01-125104	€ 37,00

ALTRE FINITURE	
XX-125098	€ 110,00 x M*
XX-125104	€ 37,00 x M*

* **MOLTIPLICATORE RICAMBI**
* **MULTIPLIER "RICAMBI"**

4203/2/1/E + 424005 + 914016

[parte esterna] [maniglia] [parte incasso]

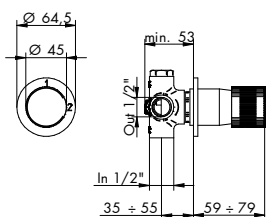
**DEVIATORE INCASSO 2 USCITE**
BUILT-IN DIVERTER 2 OUT

- > deviatore a dischi ceramici 2 uscite senza chiusura
- > attacchi da 1/2"
- > abbinare a miscelatore o rubinetti d'arresto

P. EST. - CROMATO / MAN. CROMATO	
01-4203/2/1/E	€ 107,00
01-424005	€ 86,00

P. EST. - CROMATO / MAN. IN ALTRA FINITURA	
01-4203/2/1/E	€ 107,00
XX-424005	€ 86,00 x M*

PARTE INCASSO	
914016	info pag. 36 € 102,00
PREZZO TOTALE	€ 295,00

PARTI ESTERNE - ALTRE FINITURE	
XX-4203/2/1/E	€ 107,00 x M*
XX-424005	€ 86,00 x M*



635010

4203/3/1/E + 424005 + 034127

[parte esterna] [maniglia] [parte incasso]

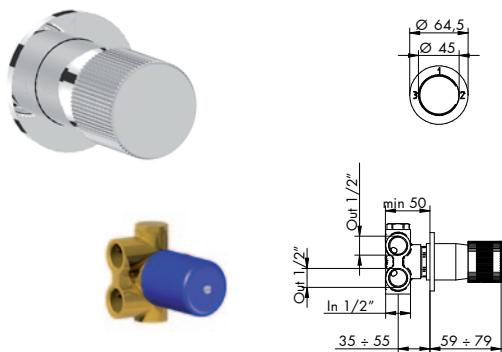

DEVIATORE INCASSO 3 USCITE
BUILT-IN DIVERTER 3 OUT

- > deviatore a dischi ceramici 3 uscite senza chiusura
- > attacchi da 1/2"
- > abbinare a miscelatore o rubinetti d'arresto

P. EST. - CROMATO / MAN. CROMATO	
01-4203/3/1/E	€ 107,00
01-424005	€ 86,00
PARTE INCASSO	
034127	info pag. 36 € 144,00
PREZZO TOTALE	€ 337,00

P. EST. - CROMATO / MAN. IN ALTRA FINITURA	
01-4203/3/1/E	€ 107,00
XX-424005	€ 86,00 x M*
PARTI ESTERNE - ALTRE FINITURE	
XX-4203/3/1/E	€ 107,00 x M*
XX-424005	€ 86,00 x M*



4203/4/1/E + 424005 + 034128

[parte esterna] [maniglia] [parte incasso]

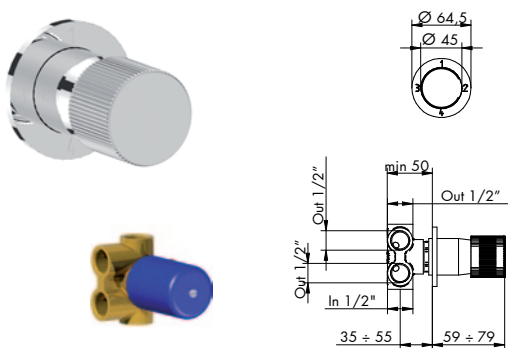

DEVIATORE INCASSO 4 USCITE
BUILT-IN DIVERTER 4 OUT

- > deviatore a dischi ceramici 4 uscite senza chiusura
- > attacchi da 1/2"
- > abbinare a miscelatore o rubinetti d'arresto

P. EST. - CROMATO / MAN. CROMATO	
01-4203/4/1/E	€ 107,00
01-424005	€ 86,00
PARTE INCASSO	
034128	info pag. 36 € 159,00
PREZZO TOTALE	€ 352,00

P. EST. - CROMATO / MAN. IN ALTRA FINITURA	
01-4203/4/1/E	€ 107,00
XX-424005	€ 86,00 x M*
PARTI ESTERNE - ALTRE FINITURE	
XX-4203/4/1/E	€ 107,00 x M*
XX-424005	€ 86,00 x M*



4212/P/E + 424003 + 484020

[parte esterna] [maniglie] [parte incasso]

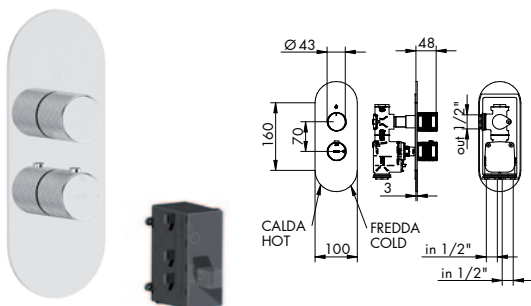

INCASSO UNIVERSALE CON B-BOX



MISCELATORE TERMOSTATICO INCASSO 1 USCITA
BUILT-IN THERMOSTATIC MIXER 1 OUT

- > cartuccia termostatica
- > vitone ceramico 90°
- > apertura con rotazione antioraria
- > ingressi inferiori da 1/2"
- > incasso con B-BOX
- > posizionabile orizzontalmente
- > interasse 70 mm
- > uscita laterale destra da 1/2"
- > incasso regolabile min 76



8816/E + 775025
p. 888 listino Rubinetteria

P. EST. - CROMATO / MAN. CROMATO	
01-4212/P/E	€ 214,00
01-424003	€ 190,00
PARTE INCASSO	
484020	info pag. 37 € 548,00
PREZZO TOTALE	€ 952,00

P. EST. - CROMATO / MAN. IN ALTRA FINITURA	
01-4212/P/E	€ 214,00
XX-424003	€ 190,00 x M*
PARTI ESTERNE - ALTRE FINITURE	
XX-4212/P/E	€ 214,00 x M*
XX-424003	€ 190,00 x M*



4212/2/P/E + 424003 + 484021

[parte esterna] [maniglie] [parte incasso]

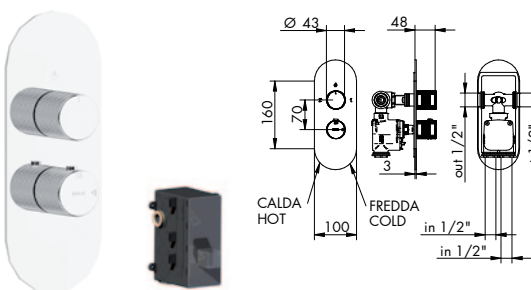

INCASSO UNIVERSALE CON B-BOX



MISCELATORE TERMOSTATICO INCASSO C/DEVIATORE 2 USCITE
BUILT-IN THERMOSTATIC MIXER WITH DIVERTER 2 OUT

- > cartuccia termostatica
- > deviatore a dischi ceramici 2 uscite c/chiusura
- > interasse 70 mm
- > ingressi inferiori da 1/2"
- > incasso con B-BOX
- > uscite laterali da 1/2"
- > incasso regolabile min 76



8816/E + 775025
p. 888 listino Rubinetteria

P. EST. - CROMATO / MAN. CROMATO	
01-4212/2/P/E	€ 214,00
01-424003	€ 190,00
PARTE INCASSO	
484021	info pag. 37 € 579,00
PREZZO TOTALE	€ 983,00

P. EST. - CROMATO / MAN. IN ALTRA FINITURA	
01-4212/2/P/E	€ 214,00
XX-424003	€ 190,00 x M*
PARTI ESTERNE - ALTRE FINITURE	
XX-4212/2/P/E	€ 214,00 x M*
XX-424003	€ 190,00 x M*



4212/3/P/E + 424003 + 484022

[parte esterna] [maniglie] [parte incasso]

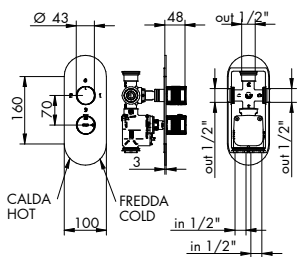

**INCASSO
UNIVERSALE
CON B-BOX**

MISCELATORE TERMOSTATICO INCASSO C/DEVIATORE 3 USCITE
BUILT-IN THERMOSTATIC MIXER WITH DIVERTER 3 OUT

- > cartuccia termostatica
- > deviatore a dischi ceramici 3 uscite c/chiusura
- > interasse 70 mm
- > uscite laterali e superiore da 1/2"
- > incasso con B-BOX
- > ingressi inferiori da 1/2"
- > incasso regolabile min 76



PILETTA DOCCIA
SHOWER WASTE

8816/E + 775025
p. 888 listino Rubinetteria

P. EST. - CROMATO / MAN. CROMATO	
01-4212/3/P/E	€ 214,00
01-424003	€ 190,00

P. EST. - CROMATO / MAN. IN ALTRA FINITURA	
01-4212/3/P/E	€ 214,00
XX-424003	€ 190,00 x M*

PARTE INCASSO	
484022	info pag. 37 € 644,00
PREZZO TOTALE € 1.048,00	

PARTI ESTERNE - ALTRE FINITURE	
XX-4212/3/P/E	€ 214,00 x M*
XX-424003	€ 190,00 x M*



CARTUCCIA
DEVIATRICE
DIVERTER CARTRIDGE

035345



CART. TERMOSTATICA
THERMOSTATIC
CARTRIDGE

775007

PER INSTALLAZIONI SU PARETI IN CARTONGESSO VERIFICARE LE DIMENSIONI DEL PANNELLO E ORDINARE LA NECESSARIA PROLUNGA
FOR INSTALLATIONS ON DRYWALL, CHECK THE DIMENSIONS OF THE PANEL AND ORDER THE NECESSARY EXTENSION

4212/4/P/E + 424003 + 484023

[parte esterna] [maniglie] [parte incasso]

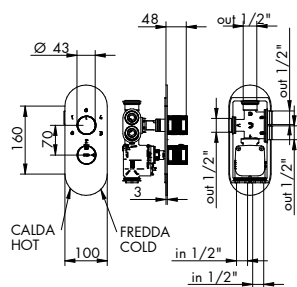

**INCASSO
UNIVERSALE
CON B-BOX**

MISCELATORE TERMOSTATICO INCASSO C/DEVIATORE 4 USCITE
BUILT-IN THERMOSTATIC MIXER WITH DIVERTER 4 OUT

- > cartuccia termostatica
- > deviatore a dischi ceramici 4 uscite c/doppia chiusura
- > interasse 70 mm
- > uscite laterali e superiore da 1/2"
- > incasso in ottone con B-BOX
- > ingressi inferiori da 1/2"
- > incasso regolabile min 76



PILETTA DOCCIA
SHOWER WASTE

8816/E + 775025
p. 888 listino Rubinetteria

P. EST. - CROMATO / MAN. CROMATO	
01-4212/4/P/E	€ 214,00
01-424003	€ 190,00

P. EST. - CROMATO / MAN. IN ALTRA FINITURA	
01-4212/4/P/E	€ 214,00
XX-424003	€ 190,00 x M*

PARTE INCASSO	
484023	info pag. 38 € 709,00
PREZZO TOTALE € 1.113,00	

PARTI ESTERNE - ALTRE FINITURE	
XX-4212/4/P/E	€ 214,00 x M*
XX-424003	€ 190,00 x M*



CARTUCCIA
DEVIATRICE
DIVERTER CARTRIDGE

035344



CART. TERMOSTATICA
THERMOSTATIC
CARTRIDGE

775007

PER INSTALLAZIONI SU PARETI IN CARTONGESSO VERIFICARE LE DIMENSIONI DEL PANNELLO E ORDINARE LA NECESSARIA PROLUNGA
FOR INSTALLATIONS ON DRYWALL, CHECK THE DIMENSIONS OF THE PANEL AND ORDER THE NECESSARY EXTENSION

094021 | 094025

KIT PROLUNGA MIX INCASSO TERMOSTATICO
BUILT-IN THERMOSTATIC MIXER EXTENSION KIT

- > lunghezza 3 cm
- > 094021 per art. 4212/2/P/E, 4212/3/P/E, 4212/4/P/E
- > 094025 per art. 4212/P/E



GREZZO		
094021	2/3/4 out	€ 170,00
094025	1 out	€ 170,00

1212/P42/E + 424004 + 125001

[parte esterna] [maniglia] [parte incasso]

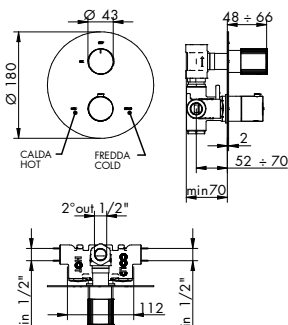

**NON COMPATIBILE
CON INCASSO
UNIVERSALE**

MISCELATORE TERMOSTATICO 1 USCITA SENZA B-BOX
BUILT-IN THERMOSTATIC MIXER 1 OUT WITHOUT B-BOX

- > cartuccia termostatica
- > vitone ceramico con rotazione di 90°
- > non compatibile con incasso universale 484020
- > incasso senza B-BOX
- > apertura con rotazione antioraria
- > ingressi laterali da 1/2"
- > incasso regolabile min 70
- > interasse 80 mm
- > uscita superiore da 1/2"



PILETTA DOCCIA
SHOWER WASTE

8816/E + 775025
p. 888 listino Rubinetteria

P. EST. - CROMATO / MAN. CROMATO	
01-1212/P42/E	€ 358,00
01-424004	€ 104,00

P. EST. - CROMATO / MAN. IN ALTRA FINITURA	
01-1212/P42/E	€ 358,00
XX-424004	€ 104,00 x M*

PARTE INCASSO	
01-125001	info pag. 38 € 414,00
PREZZO TOTALE € 876,00	

PARTI ESTERNE - ALTRE FINITURE	
XX-1212/P42/E	€ 358,00 x M*
XX-424004	€ 104,00 x M*



VITONE CERAMICO
CERAMIC VALVE

125078



CART. TERMOSTATICA
THERMOSTATIC
CARTRIDGE

775041

PER INSTALLAZIONI SU PARETI IN CARTONGESSO VERIFICARE LE DIMENSIONI DEL PANNELLO E ORDINARE LA NECESSARIA PROLUNGA
FOR INSTALLATIONS ON DRYWALL, CHECK THE DIMENSIONS OF THE PANEL AND ORDER THE NECESSARY EXTENSION

1212/2/P42/E + 424004 + 125002

[parte esterna] [maniglia] [parte incasso]

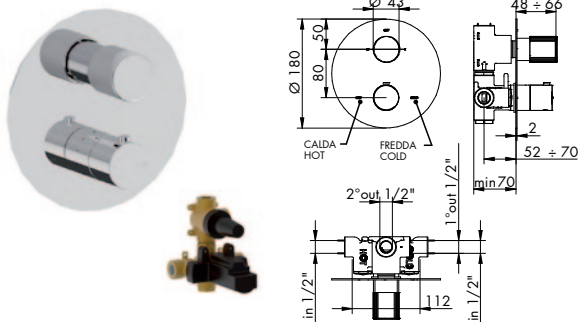

**NON COMPATIBILE
CON INCASSO
UNIVERSALE**

MISCELATORE TERMOSTATICO 2 USCITE SENZA B-BOX
BUILT-IN THERMOSTATIC MIXER 2 OUT WITHOUT B-BOX

- > cartuccia termostatica
- > non compatibile con incasso universale 484021
- > incasso senza B-BOX
- > deviatore meccanico a dischi ceramici x uscite c/chiusura
- > ingressi laterali da 1/2" > uscite superiore e laterale da 1/2"
- > incasso regolabile min 70 > interasse 80 mm



8816/E + 775025
p. 888 listino Rubinetteria

P. EST. - CROMATO / MAN. CROMATO

01-1212/2/P42/E	€ 358,00
01-424004	€ 104,00

P. EST. - CROMATO / MAN. IN ALTRA FINITURA

01-1212/2/P42/E	€ 358,00
XX-424004	€ 104,00 x M*

PARTE INCASSO

01-125002	info pag. 38	€ 566,00
-----------	--------------	----------

PARTI ESTERNE - ALTRE FINITURE

XX-1212/2/P42/E	€ 358,00 x M*
XX-424004	€ 104,00 x M*

PREZZO TOTALE € 1.028,00

PER INSTALLAZIONI SU PARETI IN CARTONGESSO VERIFICARE LE DIMENSIONI DEL PANNELLO E ORDINARE LA NECESSARIA PROLUNGA
FOR INSTALLATIONS ON DRYWALL, CHECK THE DIMENSIONS OF THE PANEL AND ORDER THE NECESSARY EXTENSION



125079



755041

1212/3/P42/E + 424004 + 125003

[parte esterna] [maniglia] [parte incasso]

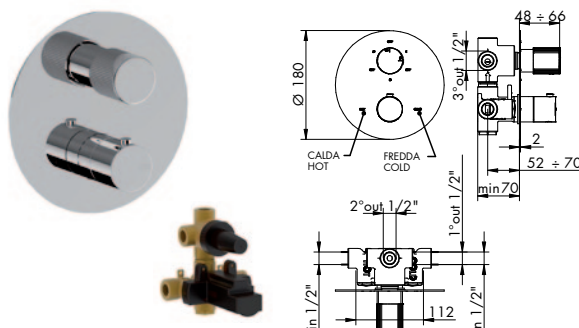

**NON COMPATIBILE
CON INCASSO
UNIVERSALE**

MISCELATORE TERMOSTATICO 3 USCITE SENZA B-BOX
BUILT-IN THERMOSTATIC MIXER 3 OUT WITHOUT B-BOX

- > cartuccia termostatica
- > non compatibile con incasso universale 484022
- > incasso senza B-BOX
- > deviatore meccanico a dischi ceramici x uscite c/doppia chiusura
- > ingressi laterali da 1/2" > uscite superiore e laterali da 1/2"
- > incasso regolabile min 70 > interasse 80 mm



8816/E + 775025
p. 888 listino Rubinetteria

P. EST. - CROMATO / MAN. CROMATO

01-1212/3/P42/E	€ 358,00
01-424004	€ 104,00

P. EST. - CROMATO / MAN. IN ALTRA FINITURA

01-1212/3/P42/E	€ 358,00
XX-424004	€ 104,00 x M*

PARTE INCASSO

01-125003	info pag. 38	€ 596,00
-----------	--------------	----------

PARTI ESTERNE - ALTRE FINITURE

XX-1212/3/P42/E	€ 358,00 x M*
XX-424004	€ 104,00 x M*

PREZZO TOTALE € 1.058,00

PER INSTALLAZIONI SU PARETI IN CARTONGESSO VERIFICARE LE DIMENSIONI DEL PANNELLO E ORDINARE LA NECESSARIA PROLUNGA
FOR INSTALLATIONS ON DRYWALL, CHECK THE DIMENSIONS OF THE PANEL AND ORDER THE NECESSARY EXTENSION



125080



755041

125100 | 125101



KIT PROLUNGA
EXTENSION KIT

- > lunghezza 3 cm
- > art. 125100: kit prolunga cartuccia termostatica
- > art. 125101: kit prolunga vitone/deviatore
- > per art. 1212/P42/E, 1212/2/P42/E, 1212/3/P42/E

GREZZO

125101	€ 31,00
--------	---------

CROMATO

01-125100	€ 119,00
-----------	----------

ALTRE FINITURE

XX-125100	€ 119,00 x M*
-----------	---------------

* MOLTIPLICATORE RICAMBI
* MULTIPLIER "RICAMBI"

PER COMANDI TERMOSTATICI ALTA PORTATA, CONSULTARE SEZIONE REVIVRE DA PAG. 326.

FOR HIGH FLOW RATE THERMOSTATIC MIXER, LOOK AT THE "REVIVRE" COLLECTION FROM PAGE 326.

8812/H/P/E + 774035	8812/2H/P/E + 774036	8812/3H/P/E + 774033	8812/4H/P/E + 774034	8812/H/E + 884036	8812/2H/E + 884037	8812/3H/E + 884038	8812/4H/E + 884039
1 OUT ALTA PORTATA HIGH FLOW RATE	2 OUT ALTA PORTATA HIGH FLOW RATE	3 OUT ALTA PORTATA HIGH FLOW RATE	4 OUT ALTA PORTATA HIGH FLOW RATE	1 OUT ALTA PORTATA HIGH FLOW RATE	2 OUT ALTA PORTATA HIGH FLOW RATE	3 OUT ALTA PORTATA HIGH FLOW RATE	4 OUT ALTA PORTATA HIGH FLOW RATE

4209/1 + 424008

[mix]

[maniglia]

MISCELATORE DOCCIA ESTERNO
EXTERNAL SHOWER MIXER

- > cartuccia tradizionale
- > senza set doccia
- > attacchi da 1/2"

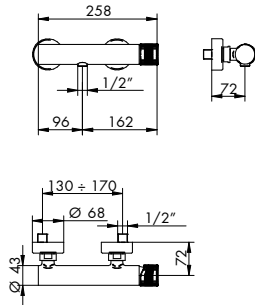

PILETTA DOCCIA
SHOWER WASTE
8816/E + 775025
p. 888 listino Rubinetteria

**CROMATO / MAN. CROMATO**

01-4209/1	€ 330,00
01-424008	€ 104,00

PREZZO TOTALE € 434,00**CROMATO / MANIGLIA IN ALTRA FINITURA**

01-4209/1	€ 330,00
XX-424008	€ 104,00 x M*

ALTRE FINITURE

XX-4209/1	€ 330,00 x M*
XX-424008	€ 104,00 x M*



CARTUCCIA
CARTRIDGE
025002

DOCCIA COMPLEMENTI CONSIGLIATI:

PER SOLUZIONI ALTERNATIVE E LISTINO PREZZI, CONSULTARE LA SEZIONE COMPLETA, DA PAG. 118.

SUGGESTED "DOCCIA COMPLEMENTI":

FOR ALTERNATIVE SOLUTIONS AND PRICE LIST, SEE THE COMPLETE COLLECTION FROM PAGE 118.



4403/1/A, 4403/1
SUPPORTO DOCCIA COMPLETO
FULL SHOWER SUPPORT



0530N
SALISCENDI COMPLETO C/PRESA D'ACQUA
COMPLETE WALL PIPE WITH WATER CONNECTION



0413/4/SP
STELO DOCCIA
ROD SHOWER

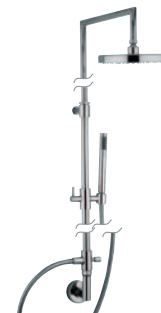

0413/5/1/SP
CURVA PRESA ACQUA C/STELO COMPLETO
CURVE WATER CONNECTOR WITH COMPLETE ROD

SOFFIONI E BRACCI CONSIGLIATI:

PER SOLUZIONI ALTERNATIVE E LISTINO PREZZI, CONSULTARE LA SEZIONE COMPLETA, DA PAG. 38.
PER COMPOSIZIONI DOCCIA CONSULTARE SEZIONE REVIVRE.

SUGGESTED "BRACCI E SOFFIONI":

FOR ALTERNATIVE SOLUTIONS AND PRICE LIST, SEE THE COMPLETE COLLECTION FROM PAGE 38.
FOR SHOWER TYPESETTING LOOK AT "REVIVRE" COLLECTION.

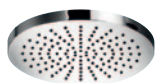

045230
SOFFIONE Ø 200 OTTONE
BRASS CEILING DIAMETER 200



045174
SOFFIONE Ø 300 OTTONE
BRASS CEILING DIAMETER 300



884055
BRACCIO DA PARETE MM 350
WALL ARM MM 350



044054
BRACCIO A SOFFITTO MM 250
CEILING ARM MM 250

COMPONI IL TUO SET DOCCIA:

PER SOLUZIONI ALTERNATIVE E LISTINO PREZZI, CONSULTARE LA SEZIONE COMPLETA, DA PAG. 186.

DESIGN YOUR SHOWER SET:

FOR ALTERNATIVE SOLUTIONS AND PRICE LIST, SEE THE COMPLETE COLLECTION FROM PAGE 186.



014083
GANCIO INCASSO FISSO
BUILT-IN FIXED HOOK



014084
SUPPORTO ESTERNO FISSO
EXTERNAL FIXED SUPPORT



445043 OTTONE
DOCCETTA MONOGETTO
MONO JET HAND SHOWER



915001 ABS
DOCCETTA MONOGETTO
MONO JET HAND SHOWER



915003
FLESSIBILE TUBO PVC L150 CM
PVC TUBE FLEXIBLE L150 CM



655016
FLESSIBILE TRECCIA OTTONE L150 CM
BRASS FLEXIBLE L150 CM



0530/1N
ASTA SALISCENDI
WALL PIPE

4201/A + 424008

[mix] [maniglia]

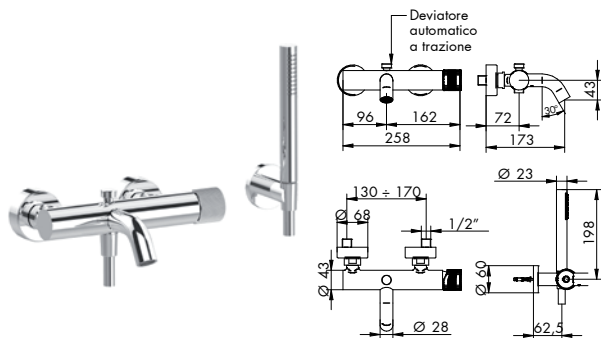

MISCELATORE VASCA ESTERNO

EXTERNAL BATH MIXER

- > cartuccia tradizionale > interasse bocca 173
- > deviatore a trazione con ritorno automatico e blocco per basse pressioni
- > flessibile in PVC 150 cm
- > supporto a parete fisso > attacchi da 1/2"
- > doccetta monogetto cilindrica in ABS c/anticalcare
- > per finiture diverse da cromo doccetta in metallo



012 p. 888
listino Rubinetteria

CROMATO / MAN. CROMATO

01-4201/A	€ 489,00
01-424008	€ 104,00

PREZZO TOTALE € 593,00

CROMATO / MANIGLIA IN ALTRA FINITURA

01-4201/A	€ 489,00
XX-424008	€ 104,00 x M*

ALTRE FINITURE

XX-4201/A	€ 489,00 x M*
XX-424008	€ 104,00 x M*



454066



484060

01- cromato / XX- finitura



025002

4201/4/AE + 424007 + 734012

[parte esterna] [maniglia] [parte incasso]

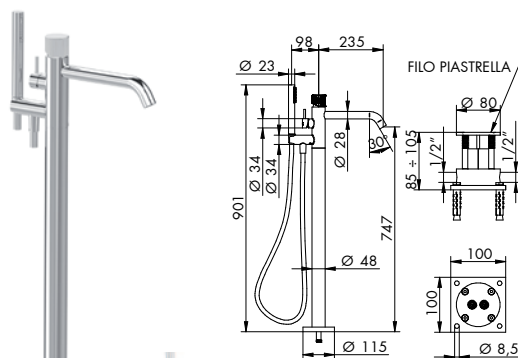

MISCELATORE VASCA C/ATTACCO A PAVIMENTO

FLOOR BATH MIXER

- > cartuccia tradizionale per erogazione alla bocca
- > cartuccia tradizionale per erogazione alla doccetta
- > interasse bocca 235 > attacchi da 1/2"
- > flessibile in PVC 150 cm > gancio incorporato
- > doccetta monogetto cilindrica in ABS c/anticalcare, per finiture diverse da cromo doccetta in metallo



012 p. 888
listino Rubinetteria

P. EST. - CROMATO / MAN. CROMATO

01-4201/4/AE	€ 1.477,00
01-424007	€ 104,00

PARTE INCASSO

734012	info pag. 30	€ 418,00
--------	--------------	----------

PREZZO TOTALE € 1.999,00

P. EST. - CROMATO / MAN. IN ALTRA FINITURA

01-4201/4/AE	€ 1.477,00
XX-424007	€ 104,00 x M*

PARTI ESTERNE - ALTRE FINITURE

XX-4201/4/AE	€ 1.477,00 x M*
XX-424007	€ 104,00 x M*



454066



045176



444021

4603

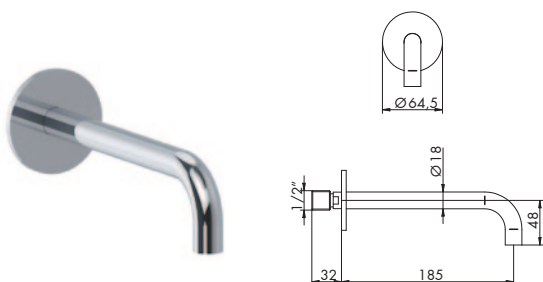

BOCCA VASCA DA PARETE

WALL BATH SPOUT

- > interasse bocca 185
- > attacchi da 1/2"



012 p. 888
listino Rubinetteria

CROMATO

01-4603	€ 102,00
---------	----------

ALTRE FINITURE

XX-4603	€ 102,00 x M*
---------	---------------



254003

044071

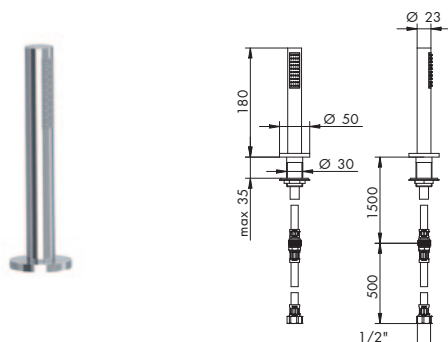

SUPPORTO DOCCIA BV TONDO COMPLETO

COMPLETE ROUND HAND SHOWER SET FOR BATH RIM

- > flessibile in PVC 150 cm
- > attacco da 1/2"
- > doccetta monogetto cilindrica in ABS c/anticalcare, per finiture diverse da cromo doccetta in metallo

CROMATO

01-044071	€ 165,00
-----------	----------

ALTRE FINITURE

XX-044071	€ 165,00x M^
-----------	--------------

^ MOLTIPLICATORE DOCCIA COMPLEMENTI
^ MULTIPLIER "DOCCIA COMPLEMENTI"

4208/E + 424006 + 054025

[parte esterna] [maniglia] [parte incasso]

RUBINETTO D'ARRESTO 1/2"
BUILT-IN STOP COCK 1/2"

> vitone ceramico 90°
 > ingressi da 1/2"

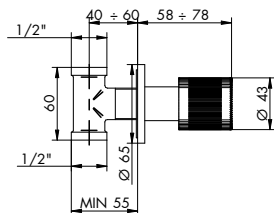

P. EST. - CROMATO / MAN. CROMATO	
01-4208/E	€ 65,00
01-424006	€ 104,00
PARTE INCASSO	
054025 info pag. 40	€ 55,00
PREZZO TOTALE	€ 224,00

P. EST. - CROMATO / MAN. IN ALTRA FINITURA	
01-4208/E	€ 65,00
XX-424006	€ 104,00 x M*
PARTI ESTERNE - ALTRE FINITURE	
XX-4208/E	€ 65,00 x M*
XX-424006	€ 104,00 x M*



4208/E + 424006 + 054027

[parte esterna] [maniglia] [parte incasso]

RUBINETTO D'ARRESTO 3/4"
BUILT-IN STOP COCK 3/4"

> vitone ceramico 90°
 > ingressi da 3/4"

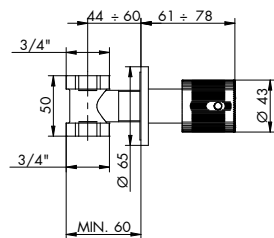

P. EST. - CROMATO / MAN. CROMATO	
01-4208/E	€ 65,00
01-424006	€ 104,00
PARTE INCASSO	
054027 info pag. 40	€ 83,00
PREZZO TOTALE	€ 252,00

P. EST. - CROMATO / MAN. IN ALTRA FINITURA	
01-4208/E	€ 65,00
XX-424006	€ 104,00 x M*
PARTI ESTERNE - ALTRE FINITURE	
XX-4208/E	€ 65,00 x M*
XX-424006	€ 104,00 x M*



4240/E + 424006 + 654099

[parte esterna] [maniglia] [parte incasso]

PASSO RAPIDO 3/4"
BUILT-IN RAPID FLOW COCK 3/4"

> vitone tradizionale
 > abbinare a saracinesca
 > ingressi da 3/4"

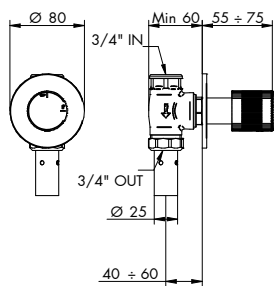

P. EST. - CROMATO / MAN. CROMATO	
01-4240/E	€ 80,00
01-424006	€ 104,00
PARTE INCASSO	
654099 info pag. 42	€ 139,00
PREZZO TOTALE	€ 323,00

P. EST. - CROMATO / MAN. IN ALTRA FINITURA	
01-4240/E	€ 80,00
XX-424006	€ 104,00 x M*
PARTI ESTERNE - ALTRE FINITURE	
XX-4240/E	€ 80,00 x M*
XX-424006	€ 104,00 x M*



4240/E + 424006 + 654100

[parte esterna] [maniglia] [parte incasso]

PASSO RAPIDO 1"
BUILT-IN RAPID FLOW COCK 1"

> vitone tradizionale
 > abbinare a saracinesca
 > ingressi da 1"

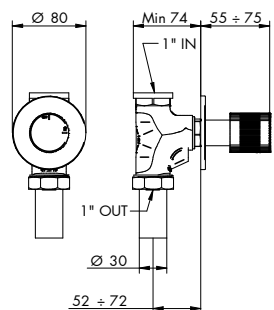

P. EST. - CROMATO / MAN. CROMATO	
01-4240/E	€ 80,00
01-424006	€ 104,00
PARTE INCASSO	
654100 info pag. 43	€ 139,00
PREZZO TOTALE	€ 323,00

P. EST. - CROMATO / MAN. IN ALTRA FINITURA	
01-4240/E	€ 80,00
XX-424006	€ 104,00 x M*
PARTI ESTERNE - ALTRE FINITURE	
XX-4240/E	€ 80,00 x M*
XX-424006	€ 104,00 x M*



4232/2/E + 424006 + 035212

[parte esterna] [maniglia] [parte incasso]

SARACINESCA

GATE VALVE

> attacchi da 3/4"

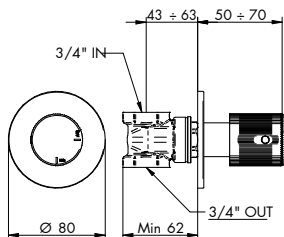

P. EST. - CROMATO / MAN. CROMATO	
01-4232/2/E	€ 70,00
01-424006	€ 104,00

P. EST. - CROMATO / MAN. IN ALTRA FINITURA	
01-4232/2/E	€ 70,00
XX-424006	€ 104,00 x M*

PARTE INCASSO	
035212	info pag. 43 € 60,00
PREZZO TOTALE	€ 234,00

PARTI ESTERNE - ALTRE FINITURE	
XX-4232/2/E	€ 70,00 x M*
XX-424006	€ 104,00 x M*

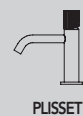



**AERATORI C/CHIAVE
AERATORS AND KEY**

254003	senza finitura	€ 9,00
454038	senza finitura	€ 12,00
454066	senza finitura	€ 8,00



**SNODINO AERATORE
JOINTS WITH AERATOR**

01-014076	cromato	€ 30,00	XX-014076	altre finiture	€ 30,00 x M*
-----------	---------	---------	-----------	----------------	--------------



**CARTUCCE
CARTRIDGES**

025002	senza finitura	€ 37,00
045076	senza finitura	€ 60,00
455039	senza finitura	€ 59,00



**DEVIATORI
DIVERTERS**

105029	senza finitura	€ 47,00			
01-484060	cromato	€ 33,00	XX-484060	altre finiture	€ 33,00 x M*
724030	senza finitura	€ 61,00			



**CARTUCCE TERMOSTATICHE
THERMOSTATIC CARTRIDGES**

755041	senza finitura	€ 95,00
775007	senza finitura	€ 73,00



**CARTUCCE DEVIATRICI
DIVERTER CARTRIDGES**

035344	senza finitura	€ 61,00
035345	senza finitura	€ 61,00
035346	senza finitura	€ 61,00
125079	senza finitura	€ 67,00
125080	senza finitura	€ 102,00
635010	senza finitura	€ 61,00
635011	senza finitura	€ 61,00
635012	senza finitura	€ 61,00



**VITONI CERAMICI
CERAMIC VALVES**

055001	senza finitura	€ 26,00
055134	senza finitura	€ 84,00
125078	senza finitura	€ 28,00
605007	senza finitura	€ 26,00



**VITONI TRADIZIONALI
TRADITIONAL VALVES**

654067	senza finitura	€ 53,00
--------	----------------	---------



PLISSET



GOLD collection

INFO TECNICHE	pag.	21 - 23
TABELLA PREZZI FINITURE	pag.	22

INDICE | INDEX

LAVABO	pag.	24
BIDET	pag.	27
DOCCIA INCASSO	pag.	27
DEVIATORI INCASSO	pag.	29
DOCCIA INCASSO TERMOSTATICO	pag.	30
DOCCIA ESTERNO	pag.	33
DOCCIA COMPLEMENTI	pag.	33
SOFFIONI/BRACCI	pag.	33
COMPONI SET DOCCIA	pag.	33
VASCA	pag.	34
BAGNO COMPLEMENTI	pag.	35
RICAMBI	pag.	37

FORATURA DEI PIANI SANITARI

I miscelatori lavabo/bidet monoforo prevedono un foro di diametro 35 mm nel piano sanitario. Le batterie lavabo 3 fori sono dotate di vitone ceramico destro con apertura a 1/4 di giro (90°); l'interasse consigliato è di 110 mm e foratura come da schema sottostante.

DRILLING PLANS HEALTH

The sink / hole bidet mixers provide a hole diameter of 35 mm in the health plan. The sink batteries 3 holes are equipped with ceramic cartridge Right-open 1/4 turn (90°); the recommended distance is 110 mm, drilling as per the diagram below.

MONOFORO >>
ONE HOLE >>



3 FORI >>
3 HOLES >>

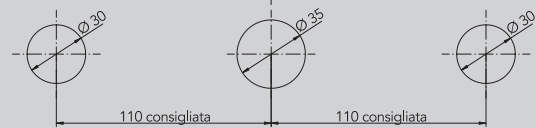

INSTALLAZIONE LAVABI A MURO

Distanza verticale consigliata tra l'uscita dell'acqua ed il bordo superiore del lavabo 8÷10 cm.

WALL-MOUNTED WASHBASIN INSTALLATION

Recommended vertical distance between the water outlet and the upper edge of the sink 8÷10 cm.

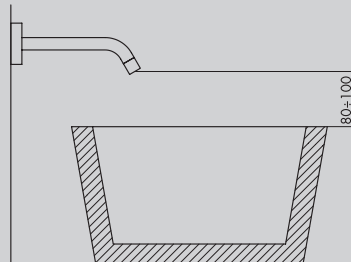

CONSIGLIO TECNICO

Tutti i miscelatori della collezione DIAMOND vengono collaudati nel loro funzionamento al momento dell'assemblaggio. Per garantire la durata delle cartucce nel tempo, si consiglia di spurgare bene l'impianto idraulico prima del montaggio (per rimuovere eventuali detriti) e di installare rubinetti sottolavabo con filtro (art. 020). N.B.: Qualora il piano lavabo avesse uno spessore superiore a 4 cm specificare la misura al momento dell'ordine.

TECHNICAL ADVICE

All mixers of the DIAMOND collection are perfectly tested. To guarantee the perfect functionality of the cartridge for a long time, we advise to clean the sanitary plant before installing the mixer. Moreover we advise to install angle valve with filter (art. 020).

Attention: If the lavatory top is more than cm 4 thick, please point it out when placing the order.

RISPARMIO IDRICO

Per il risparmio idrico, tutte le bocche lavabo e bidet hanno aeratori con portata del flusso a 5 lt/min, sostituibili con aeratori di portata superiore qualora la bocca di erogazione venga utilizzata per il riempimento vasca.

SAVING WATER

For the saving water, all the basin and bidet spout have aerator with flow rate at 5lt/min, interchangeable with more flow rate aerator, in the case of using spout for fill up the bath.

PROGETTO SU MISURA: RICHIESTE SPECIALI

I tecnici di Bellosta Rubinetterie sono, inoltre, a disposizione di architetti e designers, per offrire un servizio esclusivo: personalizzazioni di elementi in funzione di specifiche richieste estetiche o problematiche legate a vincoli progettuali, verifica della fattibilità attraverso opportuni studi CAD e sviluppo del disegno tecnico del prodotto speciale richiesto.

Per informazioni e richieste PROGETTI SU MISURA:
ufficiotecnico@bellostarubinetterie.com

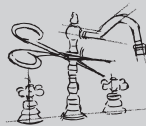

PROGETTO SU MISURA: SPECIAL REQUESTS

Engineers Bellosta Rubinetterie are also available to architects and designers, to offer an exclusive service: customizations of items according to specific aesthetic requirements or issues related to design constraints, verification of the feasibility studies and development through appropriate CAD technical design the required special product. For information and requests "SU MISURA" PROJECTS:
ufficiotecnico@bellostarubinetterie.com

progetto
"sumisura"

PREZZO FINITURE

Calcola il prezzo di listino (IVA esclusa) delle finiture diverse dal cromato, consultando la seguente tabella.

Moltiplicare il **PREZZO LISTINO** per il **COEFFICIENTE MOLTIPLICATORE** della finitura scelta, arrotondando per difetto il prezzo ottenuto (eliminare i centesimi).
ESEMPIO per ordinare art. 4205/S in finitura dorato con maniglia nero opaco: codice 04-4205/S + 67-434001

€ 199,00 (PREZZO LISTINO MIX) x 2,15 (MOLTIPLICATORE) = € ~~427,85~~ 427,00
 € 128,00 (PREZZO LISTINO MANIGLIA) x 1,45 (MOLTIPLICATORE) = € ~~185,60~~ 185,00
 € 427,00 + € 185,00 = € 612,00 PREZZO TOTALE

PRICE FINISHES

Include the list price (excluding VAT) of different finishes from chrome, consulting the following table. **Multiply the PRICE LIST MULTIPLIER COEFFICIENT** of the chosen finish, reducing the price obtained by deleting the centesim. **EXAMPLE** to order art. 4205/S gold finish with matt black handle: code 04-4205/S + 67-434001

€ 199,00 (MIX PRICE LIST) x 2,15 (MULTIPLIER) = € ~~427,85~~ 427,00
 € 128,00 (HANDLE PRICE LIST) x 1,45 (MULTIPLIER) = € ~~185,60~~ 185,00
 € 427,00 + € 185,00 = € 612,00 TOTAL PRICE

COMPOSIZIONE CODICE PER ORDINARE ARTICOLO IN FINITURA

XX - **4205/S**

CODICE FINITURA FINISH CODE CODICE ARTICOLO ITEM NUMBER +

XX - **434001**

CODICE FINITURA FINISH CODE CODICE MANIGLIA HANDLE NUMBER

**MOLTIPLICATORI FINITURE DI SERIE
 STANDARD FINISHES MULTIPLIERS**

COD. CODE	DESCRIZIONE FINITURA FINISH DESCRIPTION	DIAMOND	RICAMBI	DOCCIA COMPL.
-----------	---	---------	---------	---------------

01- cromato/chrome **PREZZO LISTINO°**

**MOLTIPLICATORI FINITURE A RICHIESTA
 ON REQUEST FINISHES MULTIPLIERS**

COD. CODE	DESCRIZIONE FINITURA FINISH DESCRIPTION	DIAMOND	RICAMBI	DOCCIA COMPL.
02-	cromo/oro/chrome/gold	x 1,50	x 1,70	x 1,50
03-	oro/argento/gold/silver	x 1,65	x 1,85	x 1,75
04-	dorato/gold	x 2,15	x 2,40	x 2,20
05-	bronzo satinato/satin bronze	x 1,65	x 1,85	x 1,75
06-	rame vecchio/old copper	x 1,65	x 1,85	x 1,75
07-	vecchio argento/old silver	x 1,65	x 1,85	x 1,75
08-	canna di fucile/gun barrel	x 2,15	x 2,40	x 2,20
10-	verderame/verdigris	x 2,15	x 2,40	x 2,20
11-	nero antracite/anthracite black	x 2,15	x 2,40	x 2,20
12-	ottone lucido/polished brass	x 1,50	x 1,70	x 1,50
13-	ottone naturale/natural brass	x 1,30	x 1,30	x 1,30
14-	bianco lucido/glossy white	x 1,45	x 1,50	x 1,45
19-	nero lucido/glossy black	x 1,45	x 1,50	x 1,45
28-	nickel satinato/satin nickel	x 1,65	x 1,85	x 1,75
30-	nickel lucido/polished nickel	x 1,65	x 1,85	x 1,75
33-	cromo satinato/satin chrome	x 1,65	x 1,85	x 1,75
34-	cromo spazzolato/brushing chrome	x 1,70	x 1,95	x 1,80
35-	nickel spazzolato/brushing nickel	x 1,65	x 1,85	x 1,75
56-	avorio/ivory	x 1,65	x 1,85	x 1,75
57-	azzurro/light blue	x 1,65	x 1,85	x 1,75
58-	verdino/light green	x 1,65	x 1,85	x 1,75

**MOLTIPLICATORI FINITURE A RICHIESTA
 ON REQUEST FINISHES MULTIPLIERS**

COD. CODE	DESCRIZIONE FINITURA FINISH DESCRIPTION	DIAMOND	RICAMBI	DOCCIA COMPL.
-----------	---	---------	---------	---------------

59-	marrone/brown	x 1,65	x 1,85	x 1,75
60-	arancio/orange	x 1,65	x 1,85	x 1,75
61-	rosso/red	x 1,65	x 1,85	x 1,75
66-	bianco opaco/mat white	x 1,45	x 1,50	x 1,45
67-	nero opaco/matt black	x 1,45	x 1,50	x 1,45
68-	rame opaco/matt copper	x 1,65	x 1,85	x 1,75
69-	argento opaco/matt silver	x 1,65	x 1,85	x 1,75
71-	oro opaco/matt gold	x 2,15	x 2,40	x 2,20
72-	bronzo opaco/matt bronze	x 1,65	x 1,85	x 1,75
75-	dorato spazzolato/brushing gold	x 2,30	x 2,55	x 2,40
87-	oro rosa/pink gold	x 2,30	x 2,55	x 2,40
88-	ottone sisal/sisal brass	x 1,50	x 1,70	x 1,50
89-	industrial	x 2,15	x 2,40	x 2,20
92-	pomice opaco/matt pumice	x 1,85	x 2,00	x 1,90
93-	arenaria opaco/matt sandstone	x 1,85	x 2,00	x 1,90
94-	tuscany spazzolato/brushing tuscany	x 1,85	x 2,00	x 1,90
95-	rame acidato/etched copper	x 2,15	x 2,40	x 2,20
96-	cemento opaco/matt cement	x 1,85	x 2,00	x 1,90
A1-	brina opaco/matt frost	x 1,85	x 2,00	x 1,90
A2-	tuscany cerato/oilskin tuscany	x 1,85	x 2,00	x 1,90
A3-	ottone acidato/etched brass	x 2,15	x 2,40	x 2,20
A4-	basalto opaco/matt basalt	x 1,85	x 2,00	x 1,90
B2-	black gun metal PVD	RICH.	RICH.	RICH.
B3-	nickel PVD	RICH.	RICH.	RICH.
B4-	matt gold PVD	RICH.	RICH.	RICH.

°PREZZO DI LISTINO PRICE LIST
 RICAMBI SPARE PARTS

* N.R. = NON REALIZZABILE NOT MADE
 DOCCIA COMPLEMENTI SHOWER COMPLEMENTS

RICH. = PREZZO A RICHIESTA ON REQUEST PRICE

NOTE:

Flex art. 915003 realizzabile nelle seguenti finiture:
 01,03,04,05,06,07,12,13,19,28,30,33,34,35,66,67,68,69,71,72,75,B2,B3,B4.
 Per altre finiture ordinare art. 655016.

NOTE:

Flex art. 915003 is available in the following finishes:
 01,03,04,05,06,07,12,13,19,28,30,33,34,35,66,67,68,69,71,72,75,B2,B3,B4.
 For other colors order the art. 655016.

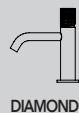

SCHEMA FUNZIONAMENTO DEVIATORI INCASSO 2/3/4 USCITE:

4203/2/1/E, 4203/3/1/E, 4203/4/1/E

Questi deviatori non hanno funzione di chiusura. Ruotando verso destra o sinistra si attivano le uscite. Tra 2 uscite adiacenti durante la rotazione diminuisce la portata dell'uscita iniziale ed incrementa quella della successiva. In posizione intermedia sono entrambe attive a pari portata.

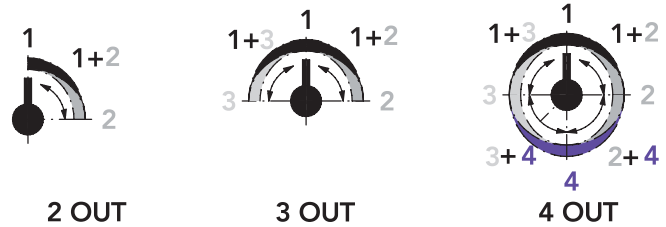

SCHEME OPERATING SWITCHES FLUSH OUTPUT 2/3/4:

4203/2/1/E, 4203/3/1/E, 4203/4/1/E

These diverters have not closing function. By turning to the right or left activates the outputs. Between two adjacent outputs during the rotation decreases the initial output flow and increases that of the next. In position intermediate are both active at the same flow rate.

SCHEMA FUNZIONAMENTO MISCELATORI TERMOSTATICI 2/3/4 USCITE:

4212/2/P/E, 4212/3/P/E, 4212/4/P/E

Leva in posizione ore 12 = deviatore chiuso. Ruotando verso destra o sinistra si attivano le diverse uscite. Partendo dalla posizione di STOP, durante la rotazione la portata dell'acqua si incrementa verso la posizione successiva. Tra 2 uscite adiacenti durante la rotazione diminuisce la portata dell'uscita iniziale ed incrementa quella della successiva. In posizione intermedia sono entrambe attive a pari portata.

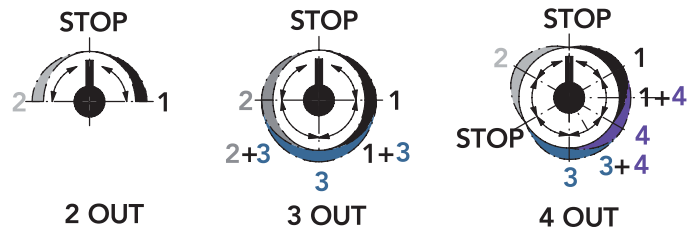

SCHEME OPERATING THERMOSTATIC MIXER 2/3/4 OUT:

4212/2/P/E, 4212/3/P/E, 4212/4/P/E

Lever to the 12 o'clock position = switch closed. Turning left or right. They activate different outputs. Starting from the STOP position, while rotation of the water flow rate between two adjacent outputs is increased towards the next position. Between two adjacent outputs during the rotation decreases the initial output flow and increases that of the next. In position intermediate are both active at the same flow rate.

SCHEMA FUNZIONAMENTO MISCELATORI INCASSO C/DEVIATORE

MECCANICO 2/3 USCITE: 1200/2/42/E, 1200/3/42/E

Questi deviatori non hanno funzione di chiusura. Ruotando verso destra o sinistra si attivano le uscite. Tra 2 uscite adiacenti durante la rotazione diminuisce la portata dell'uscita iniziale ed incrementa quella della successiva. In posizione intermedia sono entrambe attive a pari portata.

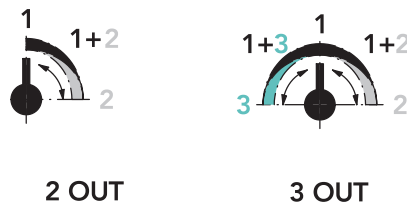

SCHEME OPERATING BUILT-IN MIXER WITH MECHANICAL DIVERTER 2/3 OUT:

1200/2/42/E, 1200/3/42/E

These diverters have not closing function. By turning to the right or left activates the outputs. Between two adjacent outputs during the rotation decreases the initial output flow and increases that of the next. In position intermediate are both active at the same flow rate.

SCHEMA FUNZIONAMENTO MISCELATORI TERMOSTATICI 2/3/4 USCITE

CON INCASSI 125002 E 125003: 1212/2/P42/E, 1212/3/P42/E

DEVIATORE A 2 USCITE: leva in posizione ore 12 = deviatore chiuso. Ruotando verso destra o sinistra si attivano le uscite. Partendo dalla posizione di STOP, durante la rotazione si incrementa la portata dell'acqua.

DEVIATORE A 3 USCITE: leva in posizione ore 12 = deviatore chiuso. Ruotando verso destra o sinistra si attivano le uscite, tra un'uscita e la successiva vi è sempre una posizione di STOP. Partendo dalla posizione di STOP, durante la rotazione si incrementa la portata dell'acqua fino al massimo in posizione di uscita, continuando la rotazione decresce la portata fino al raggiungimento della successiva posizione di STOP.

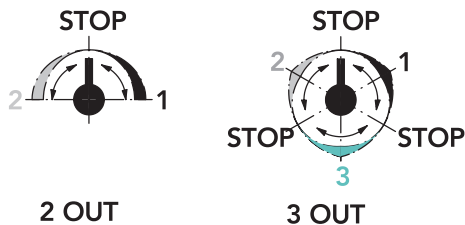

SCHEME OPERATING THERMOSTATIC MIXER 2/3/4 OUT WITH INNER SET 125002 AND 125003: 1212/2/P42/E, 1212/3/P42/E

2-OUT DIVERTER: position lever at 12 o'clock = closed diverter. Turning to the right or left activates the outputs. Starting from the STOP position, the water flow increases during rotation.

3-OUT DIVERTER: position lever at 12 o'clock = closed diverter. Turning to the right or left activates the outputs, between one output and the next there is always a STOP position. Starting from the STOP position, while the rotation increases the water flow to the maximum in the output position, continuing rotation decreases the flow until reaching the next STOP position.

4205/S + 434001

[mix] [maniglia]

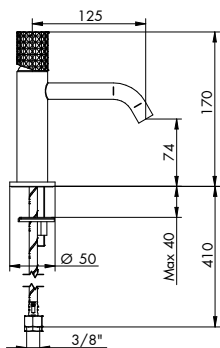

MISCELATORE LAVABO MONOFORO

BASIN MIXER

- > cartuccia tradizionale
- > interasse bocca 125
- > limitatore di portata 5 l/min 3bar
- > flessibili di alimentazione
- > senza scarico
- > abbinare a rubinetto sottolavabo con filtro (art. 020)



0136/U p. 880
listino Rubinetteria



0133/L p. 879
listino Rubinetteria

CROMATO / MAN. CROMATO	
01-4205/S	€ 199,00
01-434001	€ 128,00

PREZZO TOTALE € 327,00

CROMATO / MANIGLIA IN ALTRA FINITURA	
01-4205/S	€ 199,00
XX-434001	€ 128,00 x M*

ALTRE FINITURE	
XX-4205/S	€ 199,00 x M*
XX-434001	€ 128,00 x M*



454038



455039

4205/P/S + 434001

[mix] [maniglia]

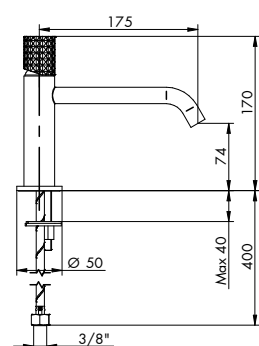

MISCELATORE LAVABO MONOFORO BOCCA PROLUNGATA

BASIN MIXER EXTENDED SPOUT

- > cartuccia tradizionale
- > interasse bocca 175
- > limitatore di portata 5 l/min 3bar
- > flessibili di alimentazione
- > senza scarico
- > abbinare a rubinetto sottolavabo con filtro (art. 020)



0136/U p. 880
listino Rubinetteria



0133/L p. 879
listino Rubinetteria

CROMATO / MAN. CROMATO	
01-4205/P/S	€ 212,00
01-434001	€ 128,00

PREZZO TOTALE € 340,00

CROMATO / MANIGLIA IN ALTRA FINITURA	
01-4205/P/S	€ 212,00
XX-434001	€ 128,00 x M*

ALTRE FINITURE	
XX-4205/P/S	€ 212,00 x M*
XX-434001	€ 128,00 x M*



454038



455039

474015 | 474016 | 474017

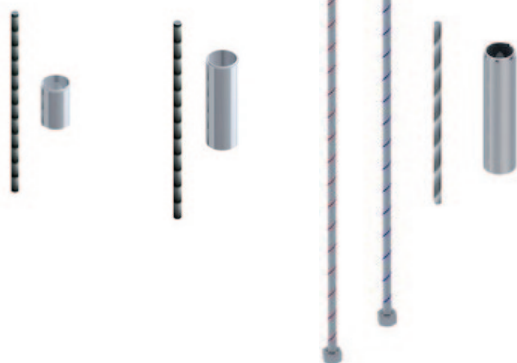

PROLUNGHE MISCELATORE LAVABO

EXTENSIONS FOR BASIN

- > diametro 34 mm
- > altezza 50 mm, 100 mm, 150 mm

CROMATO		
01-474015	50 mm	€ 61,00
01-474016	100 mm	€ 78,00
01-474017	150 mm	€ 130,00

ALTRE FINITURE		
XX-474015	50 mm	€ 61,00 x M*
XX-474016	100 mm	€ 78,00 x M*
XX-474017	150 mm	€ 130,00 x M*

4205/1 + 434001

[mix] [maniglia]

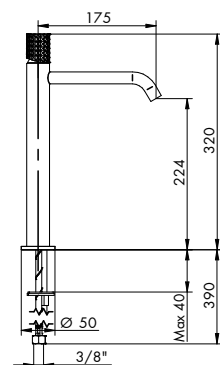

MISCELATORE LAVABO MONOFORO ALTO BOCCA PROLUNGATA

HIGHER BASIN MIXER EXTENDED SPOUT

- > cartuccia tradizionale
- > interasse bocca 175
- > limitatore di portata 5 l/min 3bar
- > flessibili di alimentazione
- > senza scarico
- > abbinare a rubinetto sottolavabo con filtro (art. 020)



0136/U p. 880
listino Rubinetteria



0133/L p. 879
listino Rubinetteria

CROMATO / MAN. CROMATO	
01-4205/1	€ 324,00
01-434001	€ 128,00

PREZZO TOTALE € 452,00

CROMATO / MANIGLIA IN ALTRA FINITURA	
01-4205/1	€ 324,00
XX-434001	€ 128,00 x M*

ALTRE FINITURE	
XX-4205/1	€ 324,00 x M*
XX-434001	€ 128,00 x M*



454038



455039

4205/3/B/E + 434002 + 894001

[parte esterna] [maniglia] [parte incasso]

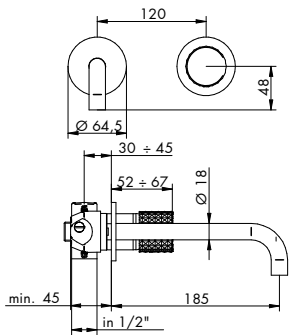
**MISCELATORE LAVABO DA PARETE BOCCA PROLUNGATA**
WALL BASIN EXTENDED SPOUT MIXER

- > cartuccia tradizionale
- > interasse bocca 185
- > limitatore di portata 5l/min 3bar
- > ingressi da 1/2"
- > senza scarico
- > rosoni separati

0136/U p. 880
listino Rubinetteria0133/L p. 879
listino Rubinetteria**P. EST. - CROMATO / MAN. CROMATO**

01-4205/3/B/E	€ 144,00
01-434002	€ 128,00

PARTE INCASSO

01-894001	info pag. 30	€ 127,00
-----------	--------------	----------

PREZZO TOTALE € 399,00**P. EST. - CROMATO / MAN. IN ALTRA FINITURA**

01-4205/3/B/E	€ 144,00
XX-434002	€ 128,00 x M*

PARTI ESTERNE - ALTRE FINITURE

XX-4205/3/B/E	€ 144,00 x M*
XX-434002	€ 128,00 x M*



454038



025002

PER INSTALLAZIONI SU PARETI IN CARTONGESSO VERIFICARE LE DIMENSIONI DEL PANNELLO E ORDINARE LA NECESSARIA PROLUNGA
FOR INSTALLATIONS ON DRYWALL, CHECK THE DIMENSIONS OF THE PANEL AND ORDER THE NECESSARY EXTENSION

4205/3/C/E + 434002 + 894001

[parte esterna] [maniglia] [parte incasso]

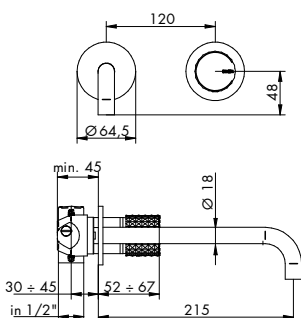
**MISCELATORE LAVABO DA PARETE BOCCA EXTRA PROLUNGATA**
WALL BASIN EXTRA EXTENDED SPOUT MIXER

- > cartuccia tradizionale
- > interasse bocca 215
- > limitatore di portata 5l/min 3bar
- > ingressi da 1/2"
- > senza scarico
- > rosoni separati

0136/U p. 880
listino Rubinetteria0133/L p. 879
listino Rubinetteria**P. EST. - CROMATO / MAN. CROMATO**

01-4205/3/C/E	€ 159,00
01-434002	€ 128,00

PARTE INCASSO

01-894001	info pag. 30	€ 127,00
-----------	--------------	----------

PREZZO TOTALE € 414,00**P. EST. - CROMATO / MAN. IN ALTRA FINITURA**

01-4205/3/C/E	€ 159,00
XX-434002	€ 128,00 x M*

PARTI ESTERNE - ALTRE FINITURE

XX-4205/3/C/E	€ 159,00 x M*
XX-434002	€ 128,00 x M*



454038



025002

PER INSTALLAZIONI SU PARETI IN CARTONGESSO VERIFICARE LE DIMENSIONI DEL PANNELLO E ORDINARE LA NECESSARIA PROLUNGA
FOR INSTALLATIONS ON DRYWALL, CHECK THE DIMENSIONS OF THE PANEL AND ORDER THE NECESSARY EXTENSION

4205/3/2/E + 434002 + 894001

[parte esterna] [maniglia] [parte incasso]

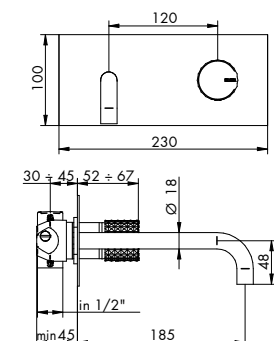
**MISCELATORE LAVABO DA PARETE BOCCA PROLUNGATA SU PIASTRA**
WALL BASIN MIXER EXTENDED SPOUT ON PLATE

- > cartuccia tradizionale
- > interasse bocca 185
- > limitatore di portata 5l/min 3bar
- > ingressi da 1/2"
- > senza scarico
- > piastra unica rettangolare

0136/U p. 880
listino Rubinetteria0133/L p. 879
listino Rubinetteria**P. EST. - CROMATO / MAN. CROMATO**

01-4205/3/2/E	€ 231,00
01-434002	€ 128,00

PARTE INCASSO

01-894001	info pag. 30	€ 127,00
-----------	--------------	----------

PREZZO TOTALE € 482,00**P. EST. - CROMATO / MAN. IN ALTRA FINITURA**

01-4205/3/2/E	€ 231,00
XX-434002	€ 128,00 x M*

PARTI ESTERNE - ALTRE FINITURE

XX-4205/3/2/E	€ 231,00 x M*
XX-434002	€ 128,00 x M*



454038



025002

PER INSTALLAZIONI SU PARETI IN CARTONGESSO VERIFICARE LE DIMENSIONI DEL PANNELLO E ORDINARE LA NECESSARIA PROLUNGA
FOR INSTALLATIONS ON DRYWALL, CHECK THE DIMENSIONS OF THE PANEL AND ORDER THE NECESSARY EXTENSION

4205/3/3/E + 434002 + 894001

[parte esterna] [maniglia] [parte incasso]

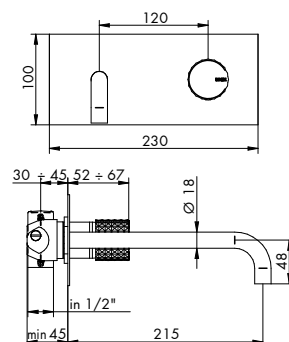
**MISCELATORE LAVABO DA PARETE BOCCA EXTRA PROLUNGATA SU PIASTRA**
WALL BASIN MIXER EXTRA EXTENDED SPOUT ON PLATE

- > cartuccia tradizionale
- > interasse bocca 215
- > limitatore di portata 5l/min 3bar
- > ingressi da 1/2"
- > senza scarico
- > piastra unica rettangolare

0136/U p. 880
listino Rubinetteria0133/L p. 879
listino Rubinetteria**P. EST. - CROMATO / MAN. CROMATO**

01-4205/3/3/E	€ 246,00
01-434002	€ 128,00

PARTE INCASSO

01-894001	info pag. 30	€ 127,00
-----------	--------------	----------

PREZZO TOTALE € 501,00**P. EST. - CROMATO / MAN. IN ALTRA FINITURA**

01-4205/3/3/E	€ 246,00
XX-434002	€ 128,00 x M*

PARTI ESTERNE - ALTRE FINITURE

XX-4205/3/3/E	€ 246,00 x M*
XX-434002	€ 128,00 x M*



454038



025002

PER INSTALLAZIONI SU PARETI IN CARTONGESSO VERIFICARE LE DIMENSIONI DEL PANNELLO E ORDINARE LA NECESSARIA PROLUNGA
FOR INSTALLATIONS ON DRYWALL, CHECK THE DIMENSIONS OF THE PANEL AND ORDER THE NECESSARY EXTENSION

4205/R/A + 434001

[mix]

[maniglia]

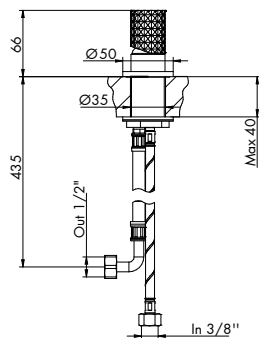
**MISCELATORE REMOTO****REMOTE MIXER**

- > cartuccia tradizionale
- > flessibili di alimentazione
- > senza scarico

SCARICO LAVABO
BASIN VASTESIFONE
SIPHON0136/U p. 880
listino Rubinetteria0133/L p. 879
listino Rubinetteria**CROMATO / MAN. CROMATO**

01-4205/R/A	€ 236,00
01-434001	€ 128,00

PREZZO TOTALE € 364,00**CROMATO / MANIGLIA IN ALTRA FINITURA**

01-4205/R/A	€ 236,00
XX-434001	€ 128,00 x M*

ALTRE FINITURE

XX-4205/R/A	€ 236,00 x M*
XX-434001	€ 128,00 x M*

CARTUCCIA
CARTRIDGE

455039

4205/R/B/E + 434002 + 104033

[parte esterna]

[maniglia]

[parte incasso]

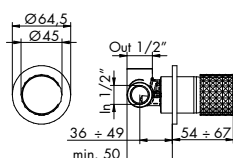
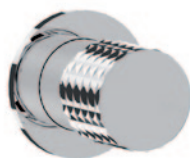
**MISCELATORE INCASSO REMOTO BUILT-IN****REMOTE MIXER**

- > cartuccia tradizionale
- > ingressi da 1/2"
- > uscita superiore
- > senza scarico
- > utilizzabile anche come incasso doccia

SCARICO LAVABO
BASIN VASTESIFONE
SIPHON0136/U p. 880
listino Rubinetteria0133/L p. 879
listino Rubinetteria**P. EST. - CROMATO / MAN. CROMATO**

01-4205/R/B/E	€ 74,00
01-434002	€ 128,00

PARTE INCASSO

01-104033	info pag. 27	€ 138,00
-----------	--------------	----------

PREZZO TOTALE € 340,00**P. EST. - CROMATO / MAN. IN ALTRA FINITURA**

01-4205/R/B/E	€ 74,00
XX-434002	€ 128,00 x M*

PARTI ESTERNE - ALTRE FINITURE

XX-4205/R/B/E	€ 74,00 x M*
XX-434002	€ 128,00 x M*

CARTUCCIA
CARTRIDGE

025002



PER INSTALLAZIONI SU PARETI IN CARTONGESSO VERIFICARE LE DIMENSIONI DEL PANNELLO E ORDINARE LA NECESSARIA PROLUNGA
FOR INSTALLATIONS ON DRYWALL, CHECK THE DIMENSIONS OF THE PANEL AND ORDER THE NECESSARY EXTENSION

104009 | 104010 | 104011**KIT PROLUNGA MIX INCASSO****BUILT-IN MIXER EXTENSION KIT**

- > lunghezza 2 cm, 3 cm, 4 cm
- > kit fondello prolunga cartuccia miscelatore + bicchiere esterno sostitutivo in finitura
- > per art. 4205/R/B/E, 4205/3/3/E, 4205/3/2/E, 4205/3/C/E, 4205/3/B/E

CROMATO

01-104009	2 cm	€ 134,00
01-104010	3 cm	€ 152,00
01-104011	4 cm	€ 183,00

ALTRE FINITURE

XX-104009	2 cm	€ 134,00 x M*
XX-104010	3 cm	€ 152,00 x M*
XX-104011	4 cm	€ 183,00 x M*

- * **MOLTIPLICATORE RICAMBI**
- * **MULTIPLIER "RICAMBI"**

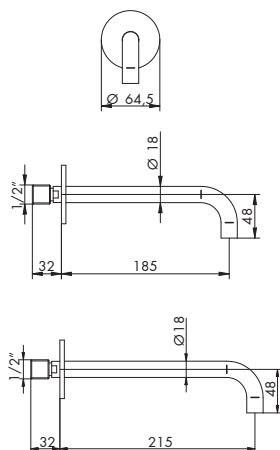
464008 | 464014**BOCCA LAVABO DA PARETE****WALL WASH SPOUT L 185**

- > interasse bocca 185 / 215
- > limitatore di portata 5 l/min 3 bar
- > attacco da 1/2"
- > rosone tondo

SCARICO LAVABO
BASIN VASTESIFONE
SIPHON0136/U p. 880
listino Rubinetteria0133/L p. 879
listino Rubinetteria**CROMATO**

01-464008	185 mm	€ 110,00
01-464014	215 mm	€ 129,00

ALTRE FINITURE

XX-464008	185 mm	€ 110,00 x M*
XX-464014	215 mm	€ 129,00 x M*

AERATORE C/CHIAVE
AERATOR W/KEY

454038

4605/1/C

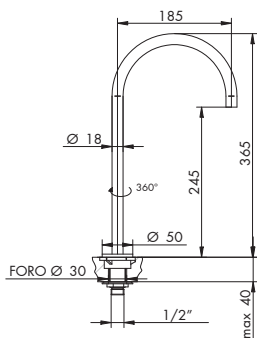
BOCCA MONOFORO GIREVOLE
SWINGING WASH SPOUT

- > interasse bocca 185
- > bocca girevole 360°
- > limitatore di portata 5 l/min 3 bar
- > attacco da 1/2"

0136/U p. 880
listino Rubinetteria0133/L p. 879
listino Rubinetteria

CROMATO

01-4605/1/C € 216,00

ALTRE FINITURE

XX-4605/1/C € 216,00 x M*



454038

4207/S + 434001

[mix] [maniglia]

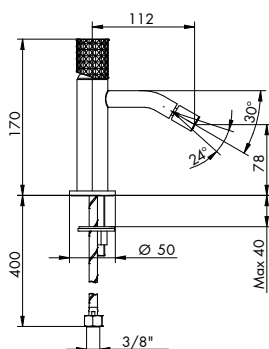
MISCELATORE BIDET MONOFORO
BIDET MIXER

- > cartuccia tradizionale
- > interasse bocca 112
- > aeratore snodato
- > limitatore di portata 5 l/min 3 Bar
- > flessibili di alimentazione
- > senza scarico

0136/U p. 880
listino Rubinetteria011/B p. 887
listino Rubinetteria

CROMATO / MAN. CROMATO

01-4207/S € 199,00

01-434001 € 128,00

PREZZO TOTALE € 327,00

CROMATO / MANIGLIA IN ALTRA FINITURA

01-4207/S € 199,00

XX-434001 € 128,00 x M*

ALTRE FINITURE

XX-4207/S € 199,00 x M*

XX-434001 € 128,00 x M*



454038



455039

464003

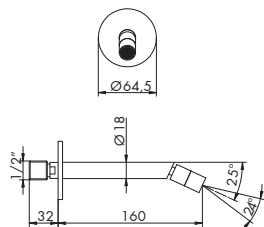
BOCCA BIDET DA PARETE
WALL BIDET SPOUT

- > interasse bocca 160
- > aeratore snodato
- > attacco da 1/2"
- > rosone tondo

0136/U p. 880
listino Rubinetteria011/B p. 887
listino Rubinetteria

CROMATO

01-464003 € 157,00

ALTRE FINITURE

XX-464003 € 157,00 x M*



014076

01- cromato / XX- finitura

4221/E + 434002 + 104018

[parte esterna] [maniglia] [parte incasso]

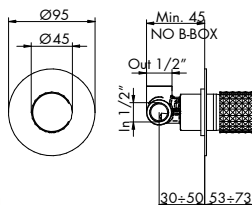
MISCELATORE INCASSO
BUILT-IN MIXER

- > cartuccia tradizionale
- > ingressi da 1/2"
- > uscita superiore
- > incasso con B-BOX

8816/E + 775025
p. 888 listino Rubinetteria

P. EST. - CROMATO / MAN. CROMATO

01-4221/E € 69,00

01-434002 € 128,00

P. EST. - CROMATO / MAN. IN ALTRA FINITURA

01-4221/E € 69,00

XX-434002 € 128,00 x M*

PARTE INCASSO

01-104018 info pag. 32 € 138,00

PREZZO TOTALE € 335,00

PARTI ESTERNE - ALTRE FINITURE

XX-4221/E € 69,00 x M*

XX-434002 € 128,00 x M*

INCASSO
UNIVERSALE
CON B-BOX

PER INSTALLAZIONI SU PARETI IN CARTONGESSO VERIFICARE LE DIMENSIONI DEL PANNELLO E ORDINARE LA NECESSARIA PROLUNGA
FOR INSTALLATIONS ON DRYWALL, CHECK THE DIMENSIONS OF THE PANEL AND ORDER THE NECESSARY EXTENSION



025002

104009 | 104010 | 104011

KIT PROLUNGA MIX INCASSO
BUILT-IN MIXER EXTENSION KIT

- > lunghezza 2 cm, 3 cm, 4 cm
- > kit fondello prolunga cartuccia miscelatore + bicchiere esterno sostitutivo in finitura
- > per art.: 4221/E

CROMATO			ALTRE FINITURE		
01-104009	2 cm	€ 134,00	XX-104009	2 cm	€ 134,00 x M*
01-104010	3 cm	€ 152,00	XX-104010	3 cm	€ 152,00 x M*
01-104011	4 cm	€ 183,00	XX-104011	4 cm	€ 183,00 x M*

* MOLTIPLICATORE RICAMBI
* MULTIPLIER "RICAMBI"

4200/E + 434002 + 104002

[parte esterna] [maniglia] [parte incasso]

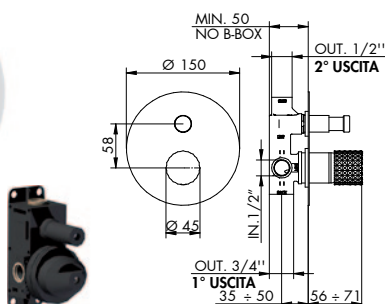
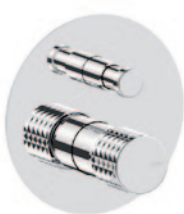

INCASSO
UNIVERSALE
CON B-BOX

MISCELATORE INCASSO C/DEVIATORE AUTOMATICO 2 USCITE
BUILT-IN MIXER WITH AUTOMATIC DIVERTER 2 OUT

- > cartuccia tradizionale
- > deviatore a pressione 2 uscite c/ritorno automatico e blocco meccanico basse pressioni
- > attacchi da 1/2"
- > uscita principale inferiore da 3/4"
- > incasso con B-BOX



8816/E + 775025
p. 888 listino Rubinetteria

P. EST. - CROMATO / MAN. CROMATO		P. EST. - CROMATO / MAN. IN ALTRA FINITURA	
01-4200/E	€ 80,00	01-4200/E	€ 80,00
01-434002	€ 128,00	XX-434002	€ 128,00 x M*
PARTE INCASSO		PARTI ESTERNE - ALTRE FINITURE	
01-104002	info pag. 33 € 281,00	XX-4200/E	€ 80,00 x M*
PREZZO TOTALE	€ 489,00	XX-434002	€ 128,00 x M*



DEVIATORE
DIVERTER
105029



CARTUCCIA
CARTRIDGE
025002

PER INSTALLAZIONI SU PARETI IN CARTONGESSO VERIFICARE LE DIMENSIONI DEL PANNELLO E ORDINARE LA NECESSARIA PROLUNGA
FOR INSTALLATIONS ON DRYWALL, CHECK THE DIMENSIONS OF THE PANEL AND ORDER THE NECESSARY EXTENSION

4200/1/P/E + 434002 + 724027

[parte esterna] [maniglia] [parte incasso]

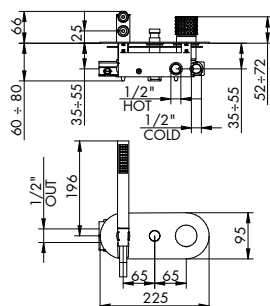

INCASSO
UNIVERSALE

MISCELATORE INCASSO C/DEVIATORE AUTOMATICO E DOCCETTA
BUILT-IN MIXER WITH AUTOMATIC DIVERTER AND HAND SHOWER

- > cartuccia tradizionale
- > deviatore a pressione 2 uscite c/ritorno automatico e blocco meccanico basse pressioni
- > attacchi da 1/2" > flessibile PVC 150 cm
- > uscita principale fianco sinistro
- > doccetta monogetto cilindrica in ABS c/anticalcare, per finiture diverse da cromo doccetta in metallo



8816/E + 775025
p. 888 listino Rubinetteria

P. EST. - CROMATO / MAN. CROMATO		P. EST. - CROMATO / MAN. IN ALTRA FINITURA	
01-4200/1/P/E	€ 245,00	01-4200/1/P/E	€ 245,00
01-434002	€ 128,00	XX-434002	€ 128,00 x M*
PARTE INCASSO		PARTI ESTERNE - ALTRE FINITURE	
01-724027	info pag. 35 € 616,00	XX-4200/1/P/E	€ 245,00 x M*
PREZZO TOTALE	€ 989,00	XX-434002	€ 128,00 x M*



DEVIATORE
DIVERTER
724030



CARTUCCIA
CARTRIDGE
025002

PER INSTALLAZIONI SU PARETI IN CARTONGESSO VERIFICARE LE DIMENSIONI DEL PANNELLO E ORDINARE LA NECESSARIA PROLUNGA
FOR INSTALLATIONS ON DRYWALL, CHECK THE DIMENSIONS OF THE PANEL AND ORDER THE NECESSARY EXTENSION

104006 | 104007 | 104008

KIT PROLUNGA MIX INCASSO CON DEVIAZIONE
BUILT-IN MIXER EXTENSION KIT WITH DIVERTER

- > lunghezza 2 cm, 3 cm, 4 cm
- > kit fondello prolunga cartuccia miscelatore e albero deviatore + bicchieri esterni sostitutivi in finitura
- > per art.: 4200/E, 4200/1/P/E

CROMATO			ALTRE FINITURE		
01-104006	2 cm	€ 171,00	XX-104006	2 cm	€ 171,00 x M*
01-104007	3 cm	€ 193,00	XX-104007	3 cm	€ 193,00 x M*
01-104008	4 cm	€ 224,00	XX-104008	4 cm	€ 224,00 x M*

* MOLTIPLICATORE RICAMBI
* MULTIPLIER "RICAMBI"

1200/2/42/E + 434009+ 124034

[parte esterna] [maniglia] [parte incasso]

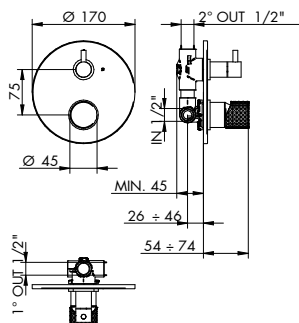
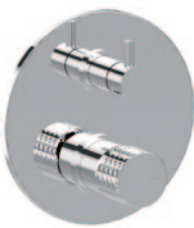

**NON COMPATIBILE
CON INCASSO
UNIVERSALE**

**MISCELATORE INCASSO C/DEVIATORE MECCANICO 2 USCITE**
BUILT-IN MIXER WITH MECHANICAL DIVERTER 2 OUT

- > cartuccia tradizionale
- > non compatibile con incasso universale 104002
- > incasso senza B-BOX
- > deviatore a dischi ceramici 2 uscite senza chiusura
- > ingressi laterali da 1/2" > interasse 75 mm
- > uscite laterale e superiore da 1/2" > incasso regolabile min 45



8816/E + 775025
p. 888 listino Rubinetteria

P. EST. - CROMATO / MAN. CROMATO	
01-1200/2/42/E	€ 131,00
01-434009	€ 146,00

P. EST. - CROMATO / MAN. IN ALTRA FINITURA	
01-1200/2/42/E	€ 131,00
XX-434009	€ 146,00 x M*

PARTE INCASSO	
01-124034	info pag. 34 € 222,00
PREZZO TOTALE	€ 499,00

PARTI ESTERNE - ALTRE FINITURE	
XX-1200/2/42/E	€ 131,00 x M*
XX-434009	€ 146,00 x M*

PER INSTALLAZIONI SU PARETI IN CARTONGESSO VERIFICARE LE DIMENSIONI DEL PANNELLO E ORDINARE LA NECESSARIA PROLUNGA
FOR INSTALLATIONS ON DRYWALL, CHECK THE DIMENSIONS OF THE PANEL AND ORDER THE NECESSARY EXTENSION



635010



025002

1200/3/42/E + 434009 + 124035

[parte esterna] [maniglia] [parte incasso]

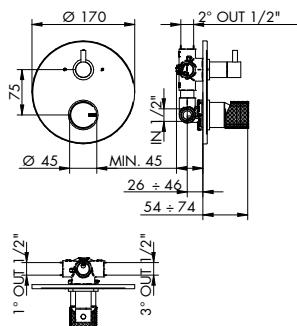
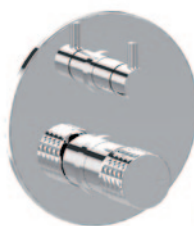

**NON COMPATIBILE
CON INCASSO
UNIVERSALE**

**MISCELATORE INCASSO C/DEVIATORE MECCANICO 3 USCITE**
BUILT-IN MIXER WITH MECHANICAL DIVERTER 3 OUT

- > cartuccia tradizionale
- > non compatibile con incasso universale 104002
- > incasso senza B-BOX
- > deviatore a dischi ceramici 3 uscite senza chiusura
- > ingressi laterali da 1/2" > interasse 75 mm
- > uscite laterale e superiore da 1/2" > incasso regolabile min 45



8816/E + 775025
p. 888 listino Rubinetteria

P. EST. - CROMATO / MAN. CROMATO	
01-1200/3/42/E	€ 131,00
01-434009	€ 146,00

P. EST. - CROMATO / MAN. IN ALTRA FINITURA	
01-1200/3/42/E	€ 131,00
XX-434009	€ 146,00 x M*

PARTE INCASSO	
01-124035	info pag. 34 € 241,00
PREZZO TOTALE	€ 518,00

PARTI ESTERNE - ALTRE FINITURE	
XX-1200/3/42/E	€ 131,00 x M*
XX-434009	€ 146,00 x M*

PER INSTALLAZIONI SU PARETI IN CARTONGESSO VERIFICARE LE DIMENSIONI DEL PANNELLO E ORDINARE LA NECESSARIA PROLUNGA
FOR INSTALLATIONS ON DRYWALL, CHECK THE DIMENSIONS OF THE PANEL AND ORDER THE NECESSARY EXTENSION



635011



025002

125098 | 125104**KIT PROLUNGA**
EXTENSION KIT

- > lunghezza 3 cm
- > art. 125098: kit fondello prolunga cartuccia miscelatore + prolunga bicchiere esterno in finitura
- > art. 125104: kit prolunga deviatore meccanico
- > per art.: 1200/2/42/E, 1200/3/42/E

CROMATO	
01-125098	€ 110,00
01-125104	€ 37,00

ALTRE FINITURE	
XX-125098	€ 110,00 x M*
XX-125104	€ 37,00 x M*

* **MOLTIPLICATORE RICAMBI**
* **MULTIPLIER "RICAMBI"**

4203/2/1/E + 434005 + 914016

[parte esterna] [maniglia] [parte incasso]

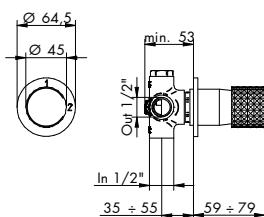
**DEVIATORE INCASSO 2 USCITE**
BUILT-IN DIVERTER 2 OUT

- > deviatore a dischi ceramici 2 uscite senza chiusura
- > attacchi da 1/2"
- > abbinare a miscelatore o rubinetti d'arresto

P. EST. - CROMATO / MAN. CROMATO	
01-4203/2/1/E	€ 107,00
01-434005	€ 128,00

P. EST. - CROMATO / MAN. IN ALTRA FINITURA	
01-4203/2/1/E	€ 107,00
XX-434005	€ 128,00 x M*

PARTE INCASSO	
914016	info pag. 36 € 102,00
PREZZO TOTALE	€ 337,00

PARTI ESTERNE - ALTRE FINITURE	
XX-4203/2/1/E	€ 107,00 x M*
XX-434005	€ 128,00 x M*



635010

PER I PREZZI DEI RICAMBI INDICATI
vedi pag. 37

XX = CODICE FINITURA RICHIESTA: per identificare codice corretto vedi pag. 22
M* = MOLTIPLICATORE: per calcolare il prezzo delle altre finiture vedi tabella pag. 22

4203/3/1/E + 434005 + 034127

[parte esterna] [maniglia] [parte incasso]

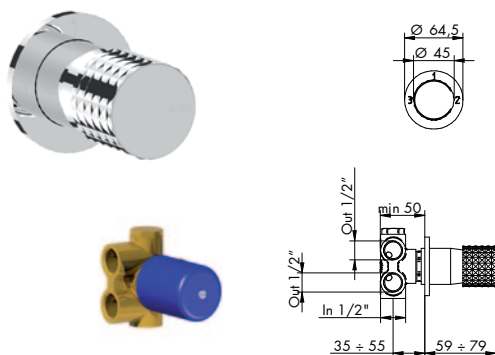

DEVIATORE INCASSO 3 USCITE
BUILT-IN DIVERTER 3 OUT

- > deviatore a dischi ceramici 3 uscite senza chiusura
- > attacchi da 1/2"
- > abbinare a miscelatore o rubinetti d'arresto

P. EST. - CROMATO / MAN. CROMATO	
01-4203/3/1/E	€ 107,00
01-434005	€ 128,00
PARTE INCASSO	
034127	info pag. 36 € 144,00
PREZZO TOTALE	€ 379,00

P. EST. - CROMATO / MAN. IN ALTRA FINITURA	
01-4203/3/1/E	€ 107,00
XX-434005	€ 128,00 x M*
PARTI ESTERNE - ALTRE FINITURE	
XX-4203/3/1/E	€ 107,00 x M*
XX-434005	€ 128,00 x M*



4203/4/1/E + 434005 + 034128

[parte esterna] [maniglia] [parte incasso]

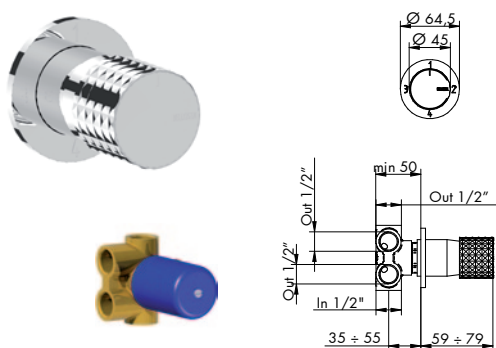

DEVIATORE INCASSO 4 USCITE
BUILT-IN DIVERTER 4 OUT

- > deviatore a dischi ceramici 4 uscite senza chiusura
- > attacchi da 1/2"
- > abbinare a miscelatore o rubinetti d'arresto

P. EST. - CROMATO / MAN. CROMATO	
01-4203/4/1/E	€ 107,00
01-434005	€ 128,00
PARTE INCASSO	
034128	info pag. 36 € 159,00
PREZZO TOTALE	€ 394,00

P. EST. - CROMATO / MAN. IN ALTRA FINITURA	
01-4203/4/1/E	€ 107,00
XX-434005	€ 128,00 x M*
PARTI ESTERNE - ALTRE FINITURE	
XX-4203/4/1/E	€ 107,00 x M*
XX-434005	€ 128,00 x M*



4212/P/E + 434003 + 484020

[parte esterna] [maniglie] [parte incasso]

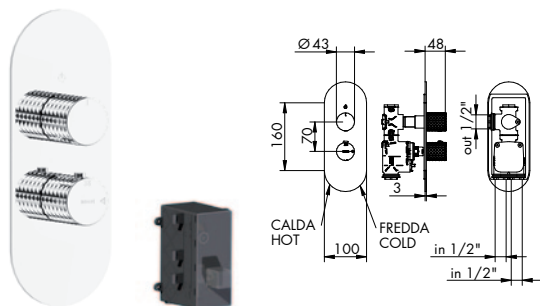

INCASSO UNIVERSALE CON B-BOX



MISCELATORE TERMOSTATICO INCASSO 1 USCITA
BUILT-IN THERMOSTATIC MIXER 1 OUT

- > cartuccia termostatica
- > vitone ceramico 90°
- > apertura con rotazione antioraria > interasse 70 mm
- > ingressi inferiori da 1/2" > uscita laterale destra da 1/2"
- > incasso con B-BOX > incasso regolabile min 76
- > posizionabile orizzontalmente

P. EST. - CROMATO / MAN. CROMATO	
01-4212/P/E	€ 214,00
01-434003	€ 274,00
PARTE INCASSO	
484020	info pag. 37 € 548,00
PREZZO TOTALE	€ 1.036,00

P. EST. - CROMATO / MAN. IN ALTRA FINITURA	
01-4212/P/E	€ 214,00
XX-434003	€ 274,00 x M*
PARTI ESTERNE - ALTRE FINITURE	
XX-4212/P/E	€ 214,00 x M*
XX-434003	€ 61,00 x M*



4212/2/P/E + 434003 + 484021

[parte esterna] [maniglie] [parte incasso]

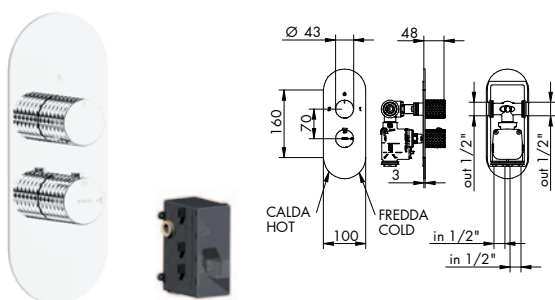

INCASSO UNIVERSALE CON B-BOX



MISCELATORE TERMOSTATICO INCASSO C/DEVIATORE 2 USCITE
BUILT-IN THERMOSTATIC MIXER WITH DIVERTER 2 OUT

- > cartuccia termostatica
- > deviatore a dischi ceramici 2 uscite c/chiusura
- > interasse 70 mm
- > ingressi inferiori da 1/2" > uscite laterali da 1/2"
- > incasso con B-BOX > incasso regolabile min 76

P. EST. - CROMATO / MAN. CROMATO	
01-4212/2/P/E	€ 214,00
01-434003	€ 274,00
PARTE INCASSO	
484021	info pag. 37 € 579,00
PREZZO TOTALE	€ 1.067,00

P. EST. - CROMATO / MAN. IN ALTRA FINITURA	
01-4212/2/P/E	€ 214,00
XX-434003	€ 274,00 x M*
PARTI ESTERNE - ALTRE FINITURE	
XX-4212/2/P/E	€ 214,00 x M*
XX-434003	€ 274,00 x M*



4212/3/P/E + 434003 + 484022

[parte esterna] [maniglie] [parte incasso]

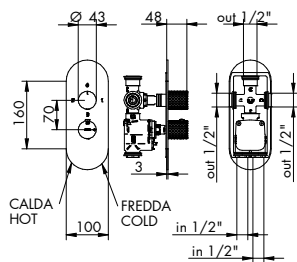
**INCASSO
UNIVERSALE
CON B-BOX**
**MISCELATORE TERMOSTATICO INCASSO C/DEVIATORE 3 USCITE**
BUILT-IN THERMOSTATIC MIXER WITH DIVERTER 3 OUT

- > cartuccia termostatica
- > deviatore a dischi ceramici 3 uscite c/chiusura
- > interasse 70 mm
- > uscite laterali e superiore da 1/2"
- > incasso con B-BOX
- > ingressi inferiori da 1/2"
- > incasso regolabile min 76

8816/E + 775025
p. 888 listino Rubinetteria

P. EST. - CROMATO / MAN. CROMATO	
01-4212/3/P/E	€ 214,00
01-434003	€ 274,00

P. EST. - CROMATO / MAN. IN ALTRA FINITURA	
01-4212/3/P/E	€ 214,00
XX-434003	€ 274,00 x M*

PARTE INCASSO	
484022	info pag. 37 € 644,00
PREZZO TOTALE € 1.132,00	

PARTI ESTERNE - ALTRE FINITURE	
XX-4212/3/P/E	€ 214,00 x M*
XX-434003	€ 274,00 x M*

PER INSTALLAZIONI SU PARETI IN CARTONGESSO VERIFICARE LE DIMENSIONI DEL PANNELLO E ORDINARE LA NECESSARIA PROLUNGA
FOR INSTALLATIONS ON DRYWALL, CHECK THE DIMENSIONS OF THE PANEL AND ORDER THE NECESSARY EXTENSION



035345



775007

4212/4/P/E + 434003 + 484023

[parte esterna] [maniglie] [parte incasso]

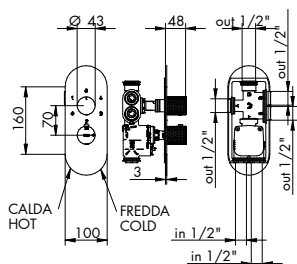
**INCASSO
UNIVERSALE
CON B-BOX**
**MISCELATORE TERMOSTATICO INCASSO C/DEVIATORE 4 USCITE**
BUILT-IN THERMOSTATIC MIXER WITH DIVERTER 4 OUT

- > cartuccia termostatica
- > deviatore a dischi ceramici 4 uscite c/doppia chiusura
- > interasse 70 mm
- > uscite laterali e superiore da 1/2"
- > incasso in ottone con B-BOX
- > ingressi inferiori da 1/2"
- > incasso regolabile min 76

8816/E + 775025
p. 888 listino Rubinetteria

P. EST. - CROMATO / MAN. CROMATO	
01-4212/4/P/E	€ 214,00
01-434003	€ 274,00

P. EST. - CROMATO / MAN. IN ALTRA FINITURA	
01-4212/4/P/E	€ 214,00
XX-434003	€ 274,00 x M*

PARTE INCASSO	
484023	info pag. 38 € 709,00
PREZZO TOTALE € 1.197,00	

PARTI ESTERNE - ALTRE FINITURE	
XX-4212/4/P/E	€ 214,00 x M*
XX-434003	€ 274,00 x M*

PER INSTALLAZIONI SU PARETI IN CARTONGESSO VERIFICARE LE DIMENSIONI DEL PANNELLO E ORDINARE LA NECESSARIA PROLUNGA
FOR INSTALLATIONS ON DRYWALL, CHECK THE DIMENSIONS OF THE PANEL AND ORDER THE NECESSARY EXTENSION



035344



775007

094021 | 094025**KIT PROLUNGA MIX INCASSO TERMOSTATICO**
BUILT-IN THERMOSTATIC MIXER EXTENSION KIT

- > lunghezza 3 cm
- > 094021 per art. 4212/2/P/E, 4212/3/P/E, 4212/4/P/E
- > 094025 per art. 4212/P/E

GREZZO	
094021	2/3/4 out € 170,00
094025	1 out € 170,00

1212/P42/E + 434004 + 125001

[parte esterna] [maniglia] [parte incasso]

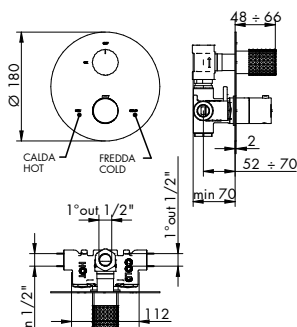
**NON COMPATIBILE
CON INCASSO
UNIVERSALE**
**MISCELATORE TERMOSTATICO 1 USCITA SENZA B-BOX**
BUILT-IN THERMOSTATIC MIXER 1 OUT WITHOUT B-BOX

- > cartuccia termostatica
- > vitone ceramico con rotazione di 90°
- > non compatibile con incasso universale 484020
- > incasso senza B-BOX
- > apertura con rotazione antioraria
- > ingressi laterali da 1/2"
- > incasso regolabile min 70
- > interasse 80 mm
- > uscita superiore da 1/2"

8816/E + 775025
p. 888 listino Rubinetteria

P. EST. - CROMATO / MAN. CROMATO	
01-1212/P42/E	€ 358,00
01-434004	€ 146,00

P. EST. - CROMATO / MAN. IN ALTRA FINITURA	
01-1212/P42/E	€ 358,00
XX-434004	€ 146,00 x M*

PARTE INCASSO	
01-125001	info pag. 38 € 414,00
PREZZO TOTALE € 918,00	

PARTI ESTERNE - ALTRE FINITURE	
XX-1212/P42/E	€ 358,00 x M*
XX-434004	€ 146,00 x M*

PER INSTALLAZIONI SU PARETI IN CARTONGESSO VERIFICARE LE DIMENSIONI DEL PANNELLO E ORDINARE LA NECESSARIA PROLUNGA
FOR INSTALLATIONS ON DRYWALL, CHECK THE DIMENSIONS OF THE PANEL AND ORDER THE NECESSARY EXTENSION



125078



775041

1212/2/P42/E + 434004 + 125002

[parte esterna] [maniglia] [parte incasso]

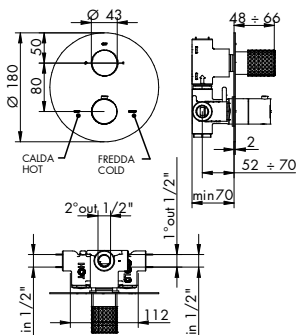

NON COMPATIBILE
CON INCASSO
UNIVERSALE



MISCELATORE TERMOSTATICO 2 USCITE SENZA B-BOX
BUILT-IN THERMOSTATIC MIXER 2 OUT WITHOUT B-BOX

- > cartuccia termostatica
- > non compatibile con incasso universale 484021
- > incasso senza B-BOX
- > deviatore meccanico a dischi ceramici x uscite c/chiusura
- > ingressi laterali da 1/2" > uscite superiore e laterale da 1/2"
- > incasso regolabile min 70 > interasse 80 mm



8816/E + 775025
p. 888 listino Rubinetteria

P. EST. - CROMATO / MAN. CROMATO	
01-1212/2/P42/E	€ 358,00
01-434004	€ 146,00

P. EST. - CROMATO / MAN. IN ALTRA FINITURA	
01-1212/2/P42/E	€ 358,00
XX-434004	€ 146,00 x M*

PARTE INCASSO	
01-125002	info pag. 38 € 566,00
PREZZO TOTALE € 1.070,00	

PARTI ESTERNE - ALTRE FINITURE	
XX-1212/2/P42/E	€ 358,00 x M*
XX-434004	€ 146,00 x M*

PER INSTALLAZIONI SU PARETI IN CARTONGESSO VERIFICARE LE DIMENSIONI DEL PANNELLO E ORDINARE LA NECESSARIA PROLUNGA
FOR INSTALLATIONS ON DRYWALL, CHECK THE DIMENSIONS OF THE PANEL AND ORDER THE NECESSARY EXTENSION



125079



755041

1212/3/P42/E + 434004 + 125003

[parte esterna] [maniglia] [parte incasso]

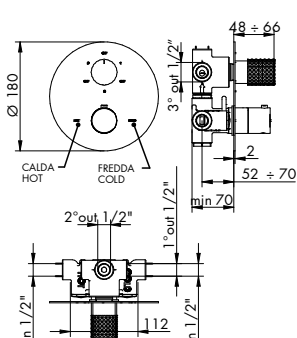

NON COMPATIBILE
CON INCASSO
UNIVERSALE



MISCELATORE TERMOSTATICO 3 USCITE SENZA B-BOX
BUILT-IN THERMOSTATIC MIXER 3 OUT WITHOUT B-BOX

- > cartuccia termostatica
- > non compatibile con incasso universale 484022
- > incasso senza B-BOX
- > deviatore meccanico a dischi ceramici x uscite c/doppia chiusura
- > ingressi laterali da 1/2" > uscite superiore e laterali da 1/2"
- > incasso regolabile min 70 > interasse 80 mm



8816/E + 775025
p. 888 listino Rubinetteria

P. EST. - CROMATO / MAN. CROMATO	
01-1212/3/P42/E	€ 358,00
01-434004	€ 146,00

P. EST. - CROMATO / MAN. IN ALTRA FINITURA	
01-1212/3/P42/E	€ 358,00
XX-434004	€ 146,00 x M*

PARTE INCASSO	
01-125003	info pag. 38 € 596,00
PREZZO TOTALE € 1.100,00	

PARTI ESTERNE - ALTRE FINITURE	
XX-1212/3/P42/E	€ 358,00 x M*
XX-434004	€ 146,00 x M*

PER INSTALLAZIONI SU PARETI IN CARTONGESSO VERIFICARE LE DIMENSIONI DEL PANNELLO E ORDINARE LA NECESSARIA PROLUNGA
FOR INSTALLATIONS ON DRYWALL, CHECK THE DIMENSIONS OF THE PANEL AND ORDER THE NECESSARY EXTENSION



125080



755041

125100 | 125101



KIT PROLUNGA
EXTENSION KIT

- > lunghezza 3 cm
- > art. 125100: kit prolunga cartuccia termostatica
- > art. 125101: kit prolunga vitone/deviatore
- > per art. 1212/P42/E, 1212/2/P42/E, 1212/3/P42/E

GREZZO	
125101	€ 31,00

CROMATO		ALTRE FINITURE	
01-125100	€ 119,00	XX-125100	€ 119,00 x M*

* MOLTIPLICATORE RICAMBI
* MULTIPLIER "RICAMBI"

PER COMANDI TERMOSTATICI ALTA PORTATA, CONSULTARE SEZIONE REVIVRE DA PAG. 326.

FOR HIGH FLOW RATE THERMOSTATIC MIXER, LOOK AT THE "REVIVRE" COLLECTION FROM PAGE 326.

8812/H/P/E + 774035	8812/2H/P/E + 774036	8812/3H/P/E + 774033	8812/4H/P/E + 774034	8812/H/E + 884036	8812/2H/E + 884037	8812/3H/E + 884038	8812/4H/E + 884039
1 OUT ALTA PORTATA HIGH FLOW RATE	2 OUT ALTA PORTATA HIGH FLOW RATE	3 OUT ALTA PORTATA HIGH FLOW RATE	4 OUT ALTA PORTATA HIGH FLOW RATE	1 OUT ALTA PORTATA HIGH FLOW RATE	2 OUT ALTA PORTATA HIGH FLOW RATE	3 OUT ALTA PORTATA HIGH FLOW RATE	4 OUT ALTA PORTATA HIGH FLOW RATE

4209/1 + 434008

[mix] [maniglia]

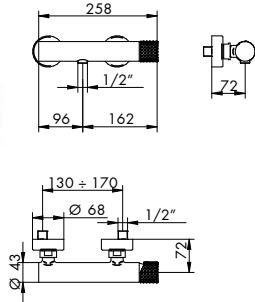
MISCELATORE DOCCIA ESTERNO
EXTERNAL SHOWER MIXER

- > cartuccia tradizionale
- > senza set doccia
- > attacchi da 1/2"



PILETTA DOCCIA
SHOWER WASTE
8816/E + 775025
p. 888 listino Rubinetteria

CROMATO / MAN. CROMATO

01-4209/1	€ 330,00
01-434008	€ 146,00

PREZZO TOTALE € 411,00

CROMATO / MANIGLIA IN ALTRA FINITURA

01-4209/1	€ 330,00
XX-434008	€ 146,00 x M*

ALTRE FINITURE

XX-4209/1	€ 330,00 x M*
XX-434008	€ 146,00 x M*



CARTUCCIA
CARTRIDGE
025002

DOCCIA COMPLEMENTI CONSIGLIATI:

PER SOLUZIONI ALTERNATIVE E LISTINO PREZZI, CONSULTARE LA SEZIONE COMPLETA, DA PAG. 118.

SUGGESTED "DOCCIA COMPLEMENTI":

FOR ALTERNATIVE SOLUTIONS AND PRICE LIST, SEE THE COMPLETE COLLECTION FROM PAGE 118.



4403/1/A, 4403/1
SUPPORTO DOCCIA COMPLETO
FULL SHOWER SUPPORT



0530N
SALISCENDI COMPLETO C/PRESA D'ACQUA
COMPLETE WALL PIPE WITH WATER CONNECTION



0413/4/SP
STELO DOCCIA
ROD SHOWER

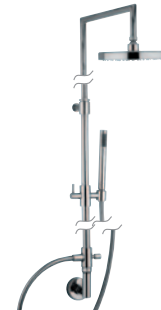

0413/5/1/SP
CURVA PRESA ACQUA C/STELO COMPLETO
CURVE WATER CONNECTOR WITH COMPLETE ROD

SOFFIONI E BRACCI CONSIGLIATI:

PER SOLUZIONI ALTERNATIVE E LISTINO PREZZI, CONSULTARE LA SEZIONE COMPLETA, DA PAG. 38.
PER COMPOSIZIONI DOCCIA CONSULTARE SEZIONE REVIVRE.

SUGGESTED "BRACCI E SOFFIONI":

FOR ALTERNATIVE SOLUTIONS AND PRICE LIST, SEE THE COMPLETE COLLECTION FROM PAGE 38.
FOR SHOWER TYPESETTING LOOK AT "REVIVRE" COLLECTION.



045230
SOFFIONE Ø 200 OTTONE
BRASS CEILING DIAMETER 200



045174
SOFFIONE Ø 300 OTTONE
BRASS CEILING DIAMETER 300



884055
BRACCIO DA PARETE MM 350
WALL ARM MM 350



044054
BRACCIO A SOFFITTO MM 250
CEILING ARM MM 250

COMPONI IL TUO SET DOCCIA:

PER SOLUZIONI ALTERNATIVE E LISTINO PREZZI, CONSULTARE LA SEZIONE COMPLETA, DA PAG. 186.

DESIGN YOUR SHOWER SET:

FOR ALTERNATIVE SOLUTIONS AND PRICE LIST, SEE THE COMPLETE COLLECTION FROM PAGE 186.



014083
GANCIO INCASSO FISSO
BUILT-IN FIXED HOOK



014084
SUPPORTO ESTERNO FISSO
EXTERNAL FIXED SUPPORT



445043 OTTONE
DOCCETTA MONOGETTO
MONO JET HAND SHOWER



915001 ABS
DOCCETTA MONOGETTO
MONO JET HAND SHOWER



915003
FLESSIBILE TUBO PVC L150 CM
PVC TUBE FLEXIBLE L150 CM



655016
FLESSIBILE TRECCIA OTTONE L150 CM
BRASS FLEXIBLE L150 CM



0530/1N
ASTA SALISCENDI
WALL PIPE

4201/A + 434008

[mix] [maniglia]

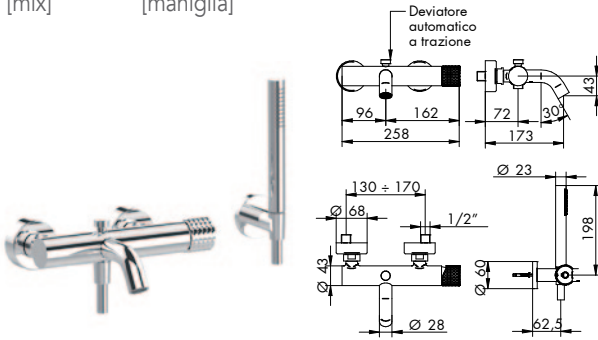

MISCELATORE VASCA ESTERNO

EXTERNAL BATH MIXER

- > cartuccia tradizionale > interasse bocca 173
- > deviatore a trazione con ritorno automatico e blocco per basse pressioni
- > flessibile in PVC 150 cm
- > supporto a parete fisso > attacchi da 1/2"
- > doccetta monogetto cilindrica in ABS c/anticalcare
- > per finiture diverse da cromo doccetta in metallo

 SCARICO VASCA BATH WASTE
012 p. 888
listino Rubinetteria

CROMATO / MAN. CROMATO

01-4201/A	€ 489,00
01-434008	€ 146,00

PREZZO TOTALE € 635,00

CROMATO / MANIGLIA IN ALTRA FINITURA

01-4201/A	€ 489,00
XX-434008	€ 146,00 x M*

ALTRE FINITURE

XX-4201/A	€ 489,00 x M*
XX-434008	€ 146,00 x M*

 AERATORE C/CHIAVE AERATOR W/KEY
454066

 DEVIATORE DIVERTER
484060
01- cromato / XX- finitura

 CARTUCCIA CARTRIDGE
025002

4201/4/AE + 434007 + 734012

[parte esterna] [maniglia] [parte incasso]

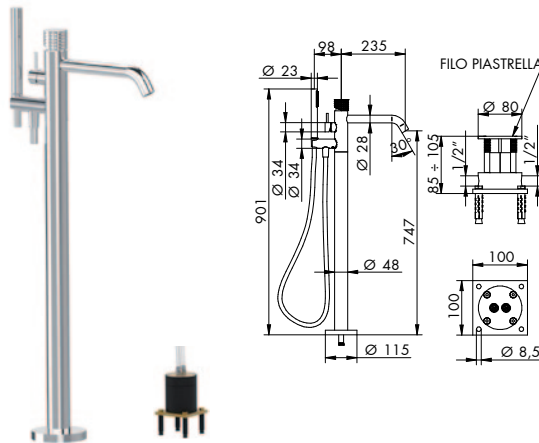

MISCELATORE VASCA C/ATTACCO A PAVIMENTO

FLOOR BATH MIXER

- > cartuccia tradizionale per erogazione alla bocca
- > cartuccia tradizionale per erogazione alla doccetta
- > interasse bocca 235 > attacchi da 1/2"
- > flessibile in PVC 150 cm > gancio incorporato
- > doccetta monogetto cilindrica in ABS c/anticalcare, per finiture diverse da cromo doccetta in metallo

 SCARICO VASCA BATH WASTE
012 p. 888
listino Rubinetteria

P. EST. - CROMATO / MAN. CROMATO

01-4201/4/AE	€ 1.477,00
01-434007	€ 146,00

PARTE INCASSO

734012	info pag. 30	€ 418,00
--------	--------------	----------

PREZZO TOTALE € 2.041,00

P. EST. - CROMATO / MAN. IN ALTRA FINITURA

01-4201/4/AE	€ 1.477,00
XX-434007	€ 146,00 x M*

PARTI ESTERNE - ALTRE FINITURE

XX-4201/4/AE	€ 1.477,00 x M*
XX-434007	€ 146,00 x M*

 AERATORE C/CHIAVE AERATOR W/KEY
454066

 CARTUCCIA BOCCA SPOUT CARTRIDGE
045176

 CARTUCCIA DOCCETTA HANDSET CARTRIDGE
444021

4603

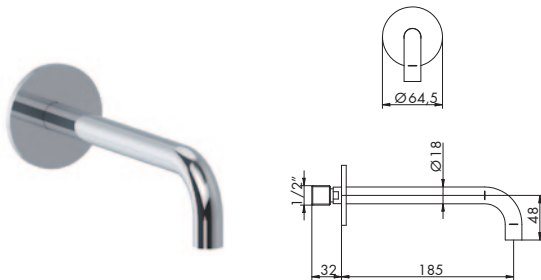

BOCCA VASCA DA PARETE

WALL BATH SPOUT

- > interasse bocca 185
- > attacchi da 1/2"

 SCARICO VASCA BATH WASTE
012 p. 888
listino Rubinetteria

CROMATO

01-4603	€ 102,00
---------	----------

ALTRE FINITURE

XX-4603	€ 102,00 x M*
---------	---------------

 AERATORE C/CHIAVE AERATOR W/KEY
254003

044071

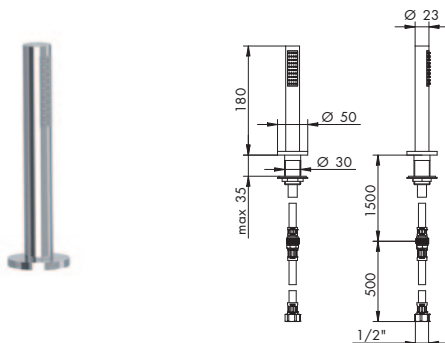

SUPPORTO DOCCIA BV TONDO COMPLETO

COMPLETE ROUND HAND SHOWER SET FOR BATH RIM

- > flessibile in PVC 150 cm
- > attacco da 1/2"
- > doccetta monogetto cilindrica in ABS c/anticalcare, per finiture diverse da cromo doccetta in metallo

CROMATO

01-044071	€ 165,00
-----------	----------

ALTRE FINITURE

XX-044071	€ 165,00 x M^
-----------	---------------

^ MOLTIPLICATORE DOCCIA COMPLEMENTI
^ MULTIPLIER "DOCCIA COMPLEMENTI"

4208/E + 434006 + 054025

[parte esterna] [maniglia] [parte incasso]

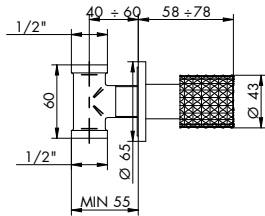
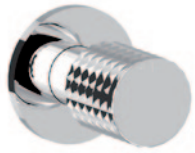

RUBINETTO D'ARRESTO 1/2"
BUILT-IN STOP COCK 1/2"

> vitone ceramico 90°
> ingressi da 1/2"

P. EST. - CROMATO / MAN. CROMATO	
01-4208/E	€ 65,00
01-434006	€ 146,00
PARTE INCASSO	
054025	info pag. 40 € 55,00
PREZZO TOTALE	€ 266,00

P. EST. - CROMATO / MAN. IN ALTRA FINITURA	
01-4208/E	€ 65,00
XX-434006	€ 146,00 x M*
PARTI ESTERNE - ALTRE FINITURE	
XX-4208/E	€ 65,00 x M*
XX-434006	€ 146,00 x M*



VITONE CERAMICO
CERAMIC VALVE
055001

4208/E + 434006 + 054027

[parte esterna] [maniglia] [parte incasso]

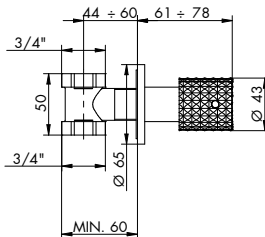
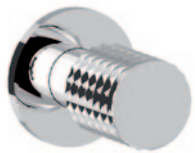

RUBINETTO D'ARRESTO 3/4"
BUILT-IN STOP COCK 3/4"

> vitone ceramico 90°
> ingressi da 3/4"

P. EST. - CROMATO / MAN. CROMATO	
01-4208/E	€ 65,00
01-434006	€ 146,00
PARTE INCASSO	
054027	info pag. 40 € 83,00
PREZZO TOTALE	€ 294,00

P. EST. - CROMATO / MAN. IN ALTRA FINITURA	
01-4208/E	€ 65,00
XX-434006	€ 146,00 x M*
PARTI ESTERNE - ALTRE FINITURE	
XX-4208/E	€ 65,00 x M*
XX-434006	€ 146,00 x M*



VITONE CERAMICO
CERAMIC VALVE
055001

4240/E + 434006 + 654099

[parte esterna] [maniglia] [parte incasso]

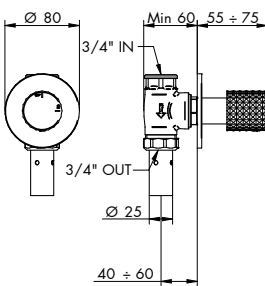
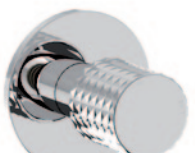

PASSO RAPIDO 3/4"
BUILT-IN RAPID FLOW COCK 3/4"

> vitone tradizionale
> abbinare a saracinesca
> ingressi da 3/4"

P. EST. - CROMATO / MAN. CROMATO	
01-4240/E	€ 80,00
01-434006	€ 146,00
PARTE INCASSO	
654099	info pag. 42 € 139,00
PREZZO TOTALE	€ 365,00

P. EST. - CROMATO / MAN. IN ALTRA FINITURA	
01-4240/E	€ 80,00
XX-434006	€ 146,00 x M*
PARTI ESTERNE - ALTRE FINITURE	
XX-4240/E	€ 80,00 x M*
XX-434006	€ 146,00 x M*



VITONE TRADIZIONALE
TRADITIONAL VALVE
654067

4240/E + 434006 + 654100

[parte esterna] [maniglia] [parte incasso]

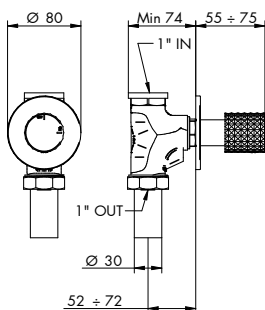
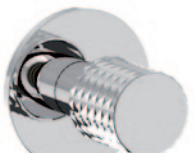

P. EST. - CROMATO / MAN. CROMATO	
01-4240/E	€ 80,00
01-434006	€ 146,00
PARTE INCASSO	
654100	info pag. 43 € 139,00
PREZZO TOTALE	€ 365,00

P. EST. - CROMATO / MAN. IN ALTRA FINITURA	
01-4240/E	€ 80,00
XX-434006	€ 146,00 x M*
PARTI ESTERNE - ALTRE FINITURE	
XX-4240/E	€ 80,00 x M*
XX-434006	€ 146,00 x M*



VITONE TRADIZIONALE
TRADITIONAL VALVE
654067

4232/2/E + 434006 + 035212

[parte esterna] [maniglia] [parte incasso]

SARACINESCA

GATE VALVE

> attacchi da 3/4"

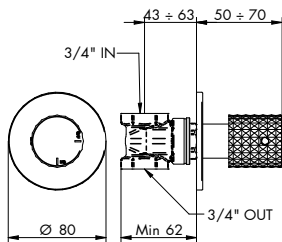
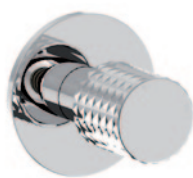

P. EST. - CROMATO / MAN. CROMATO	
01-4232/2/E	€ 70,00
01-434006	€ 146,00

P. EST. - CROMATO / MAN. IN ALTRA FINITURA	
01-4232/2/E	€ 70,00
XX-434006	€ 146,00 x M*

PARTE INCASSO	
035212	info pag. 43 € 60,00
PREZZO TOTALE	€ 276,00

PARTI ESTERNE - ALTRE FINITURE	
XX-4232/2/E	€ 70,00 x M*
XX-434006	€ 146,00 x M*

**AERATORI C/CHIAVE
AERATORS AND KEY**

254003	senza finitura	€ 9,00
454038	senza finitura	€ 12,00
454066	senza finitura	€ 8,00

**SNODINO AERATORE
JOINTS WITH AERATOR**

01-014076	cromato	€ 30,00	XX-014076	altre finiture	€ 30,00 x M*
-----------	---------	---------	-----------	----------------	--------------

**CARTUCCE
CARTRIDGES**

025002	senza finitura	€ 37,00
045076	senza finitura	€ 60,00
455039	senza finitura	€ 59,00

**DEVIATORI
DIVERTERS**

105029	senza finitura	€ 47,00			
01-484060	cromato	€ 33,00	XX-484060	altre finiture	€ 33,00 x M*
724030	senza finitura	€ 61,00			

**CARTUCCE TERMOSTATICHE
THERMOSTATIC CARTRIDGES**

755041	senza finitura	€ 95,00
775007	senza finitura	€ 73,00

**CARTUCCE DEVIATRICI
DIVERTER CARTRIDGES**

035344	senza finitura	€ 61,00
035345	senza finitura	€ 61,00
035346	senza finitura	€ 61,00
125079	senza finitura	€ 67,00
125080	senza finitura	€ 102,00
635010	senza finitura	€ 61,00
635011	senza finitura	€ 61,00
635012	senza finitura	€ 61,00

**VITONI CERAMICI
CERAMIC VALVES**

055001	senza finitura	€ 26,00
055134	senza finitura	€ 84,00
125078	senza finitura	€ 28,00
605007	senza finitura	€ 26,00

**VITONI TRADIZIONALI
TRADITIONAL VALVES**

654067	senza finitura	€ 53,00
--------	----------------	---------

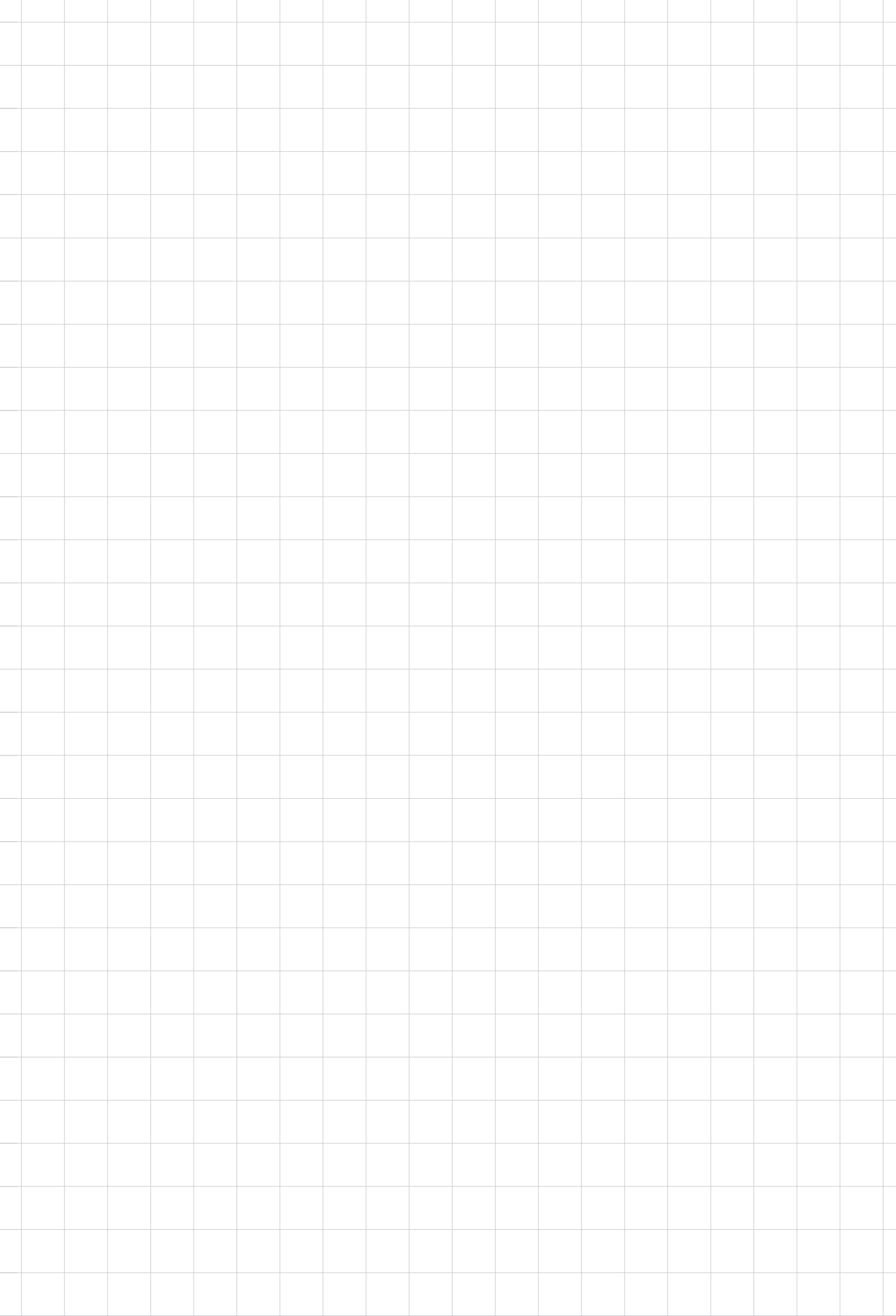

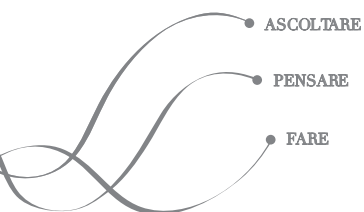

ASCOLTARE, PENSARE, FARE è la formula che abbiamo scelto per descrivere l'attenzione con cui interpretiamo i desideri del cliente, elaboriamo soluzioni ed esprimiamo proposte che ne soddisfino i gusti e le esigenze. Con lo stesso spirito, con lo stesso entusiasmo, oggi come sessant'anni fa.

LISTEN, THINK, ACT is the philosophy that we use to describe the attention by which we interpret the wishing of the client, we find solution and make proposal for meet the taste and exigent. With the same mind and passion, today like sixty years ago.

© 2022 Bellosta Rubinetterie. Tutti i diritti riservati.

GRAPHIC:
Roberta Teruggi

CONCEPT:
aCB

BELLOSTA CARLO & C. RUBINETTERIE Srl
Via S. Botticelli, 12/14 | 28024 Briga Novarese (No) Italia
Ingresso showroom: Largo Carlo Bellosta | Briga Novarese (No) Italia
Atelier Milano: Via Montenapoleone, 22
Atelier Roma: Piazza di Spagna, ingresso Via Gregoriana 23

T +39 0322 956 425 | 0322 912 330 | 0322 946 84
F +39 0322 955 368 | info@bellostarubinetterie.com
Export department: estero@bellostarubinetterie.com

Follow us on [instagram](#), [facebook](#), [youTube](#), [linked in](#), [twitter](#)

Visit our website on bellostarubinetterie.com

RIVENDITORE | AGENTE D'AREA

RETAILER | CONTACT AREA

