

COLLEZIONI
D'AUTORE

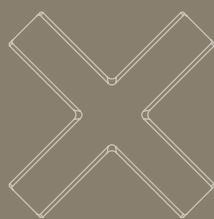

MOVIDA
EQB DESIGN

 **BELLOSTA**[®]
rubinetterie
rubinetti d'autore made in Italy

index

progetto su misura	2
finiture d'autore	3
fotografico Movida tradizionale	4
fotografico Movida miscelatore	12
listino prezzi	21

COLLEZIONI D'AUTORE



manifattura completamente italiana

progetto su misura - customizing project

prodotto

Ad architetti e progettisti si vuole offrire l'opportunità di un servizio esclusivo, PROGETTO SU MISURA, personalizzando gli elementi in funzione di specifiche richieste estetiche o problematiche legate a vincoli progettuali. Oltre trenta linee, sviluppate su scala industriale si prestano ad essere modificate nelle dimensioni, nei componenti e nelle finiture per diventare la soluzione ideale in tutte le situazioni in cui è necessario uscire dagli standard.

Per informazioni e richieste PROGETTI SU MISURA: ufficiotecnico3@bellostarubinetterie.com

product

To any architects or designers we would offer an exclusive service, the PROGETTO SU MISURA, by customizing the elements in relationship at specific aesthetic request or about projection duty. The size, components and finishings of over thirty industrial scale lines can be modified to perfectly fit all those situations that demand non-standard solutions.

For informations and PROJECTS "SU MISURA" requests: ufficiotecnico3@bellostarubinetterie.com

colore

Il servizio PROGETTO SU MISURA non si limita alla personalizzazione a 360° delle componenti dimensionali del prodotto. La scelta della finitura a volte ricade sul cromato perchè è difficile trovare nei complementi di arredo la stessa tonalità. Grazie a SU MISURA COLORS è possibile ottenere lo stesso colore sia sugli articoli presenti a listino sia sui componenti non prodotti da Bellosta Rubinetterie: maniglie, cerniere wc, piedini vasca, applique, profili doccia sono solo alcuni degli elementi realizzabili nella finitura scelta.

E' possibile inviare all'ufficio tecnico i complementi che si desidera ritrattare, per poterne valutare la fattibilità.





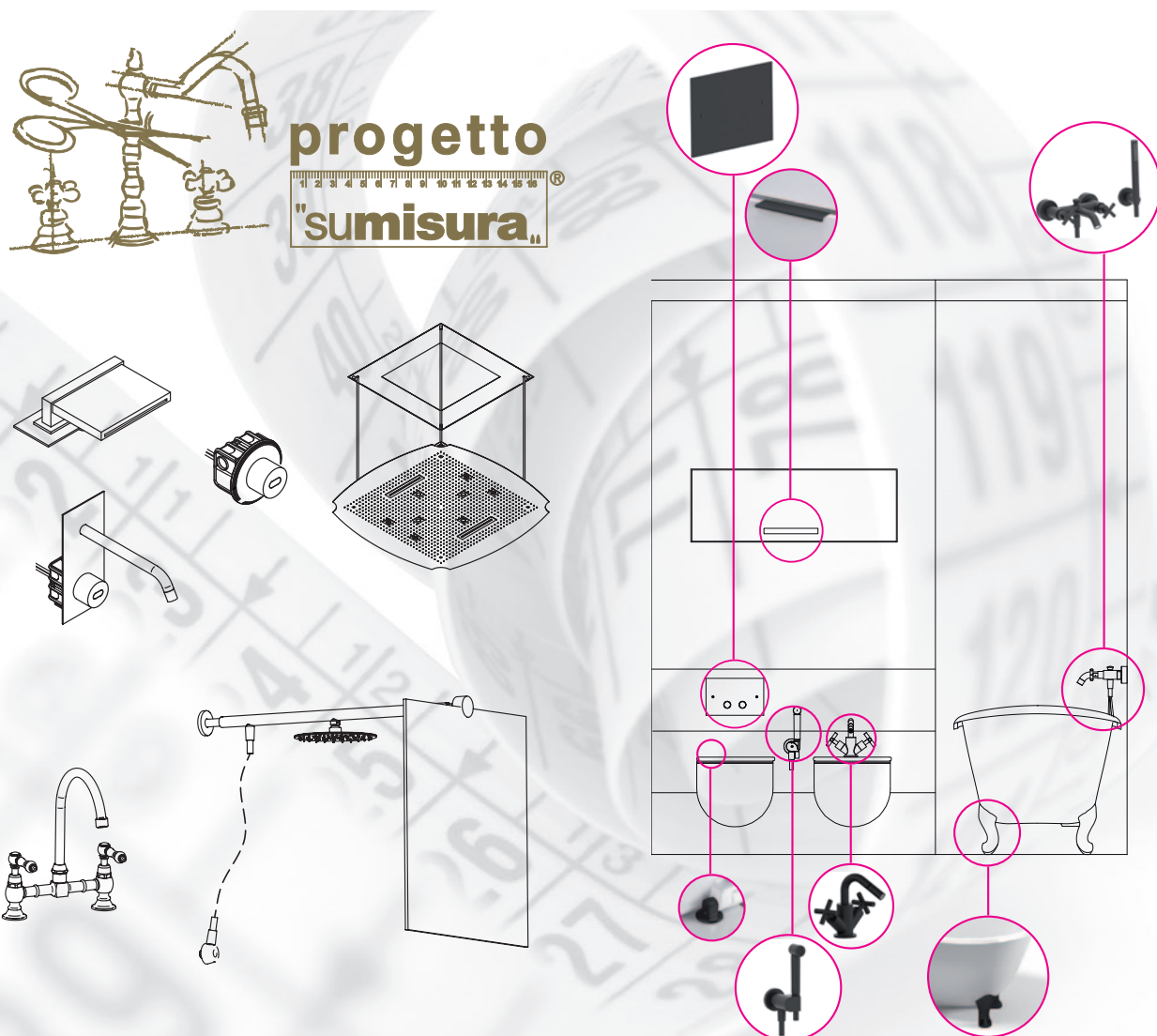







































color

The PROGETTO SU MISURA service is not limited to the 360° customization of the dimensional components of the product. The choice of finish sometimes point on the chrome because it is difficult to find the same tonality in the furnishing complements. Thanks to SU MISURA COLORS, it is possible to obtain the same color on both the faucet collection and the components not produced by Bellosta Rubinetterie: handles, hinges, bathtub legs, applique, shower profiles are just some of the elements that the company can turn into the finishing choice. It is possible to send to the technical office the complements that you would like to retract, in order to evaluate the feasibility.



finiture d'autore - artist finishing

Anteporre il codice finitura al codice articolo. Es: **01-codice articolo** per finitura cromato.
Before the code article insert the reference finish. Ex: **01-code** for the chrome color.

 01 cromato chrome	 13 ottone naturale natural brass	 59 marrone brown	 88 ottone sisal sisal brass
 02 cromo/oro chrome/gold	 14 bianco white	 60 arancio orange	 89 industrial industrial
 03 oro/argento gold/silver	 19 nero black	 61 rosso red	 92 pomice opaco matt pumice
 04 dorato gold	 28 nickel satinato satin nickel	 66 bianco opaco matt white	 93 arenaria opaco matt sandstone
 05 bronzo satinato satin bronze	 30 nickel lucido polished nickel	 67 nero opaco matt black	 94 tuscany spazzolato brushing tuscany
 06 rame vecchio old copper	 33 cromo satinato satin chrome	 68 rame opaco matt copper	 95 rame acidato etched copper
 07 vecchio argento old silver	 34 cromo spazzolato brushing chrome	 69 argento opaco matt silver	 96 cemento opaco matt cement
 08 canna di fucile gun barrel	 35 nickel spazzolato brushing nickel	 71 oro opaco matt gold	 A1 brina opaco matt frost
 10 verderame verdigris	 56 avorio ivory	 72 bronzo opaco matt bronze	 A2 tuscany cerato oilskin tuscany
 11 nero antracite anthracite black	 57 azzurro light blue	 75 dorato spazzolato brushing gold	 A3 ottone acidato etched brass
 12 ottone lucido polished brass	 58 verdino light green	 87 oro rosa pink gold	 A4 basalto opaco matt basalt

garanzia

Si ricorda che la Garanzia sulle finiture DECADE nel momento in cui manutenzione e pulizia NON vengano effettuate in modo adeguato e continuativo.

warranty

Please note that the Warranty on finishes DECAY when maintenance and cleaning NOT be made adequately and continuously.

Le finiture d'autore Bellostà sono il risultato dell'artigianalità della produzione italiana della nostra azienda: eventuali differenze di tonalità non sono da considerarsi difetto, ma caratteristica di unicità del prodotto.

Bellostà color finishes are the result of a handcrafted Italian production of our firm: any eventual difference of shade, are not to consider like a defect, but like a unique featuring of the product.

manutenzione e pulizia

Asciugare sempre con un panno morbido immediatamente dopo l'uso. Non utilizzare mai detersivi, agenti chimici, spugne abrasive, pagliette metalliche, alcool, che danneggerebbero irrimediabilmente le superfici del prodotto. Pulire esclusivamente con sapone neutro, abbondante acqua asciugare con panno morbido.

maintenance and cleaning

Always dry with a soft cloth immediately after use. Never use detergents, chemicals, abrasive sponges, scouring pads, alcohol, which could cause irreparable damage to the product surfaces. Clean only with natural/fresh soap, plenty of water and dry with a soft cloth.

MOVIDA

tradizionale

DESIGN EQB



94-5605/2/B/S tuscanly spazzolato
brushing tuscanly





La caratteristica della collezione Movidà è la maniglia a quattro punte piatta.

The most important aesthetic characteristic of "Movidà" collection is the flat four-pointed handle.

01-5605/4/B/S



93-5605/6/E + 054061



75-5605/2/B/S



66-5607/4/S



01-5607/2/S



68-5612/4/P/E + 484023

68-6531/4/C/D/E + 654091
ref. Listino REVIVRE ESSENCE
68-4403/1/A



12-5609/5/1



01-5601/A



01-5600/3/E + 054059

01-4603
01-4630



MOVIDA

DESIGN EQB



A1-5605/S brina opaco
matt frost





01-5605/1



01-5605/S



01-5607/S



01-5605/3/B/E + 01-894001



67-5600/E + 01-104002

67-884055

ref. Listino REVIVRE BRACCI

67-045174

ref. Listino REVIVRE SOFFIONE
STANDARD

67-4403/1/A



67-5605/3/B/E + 01-894001



87-5607/S



A4-5605/R/B/E + 01-104033



72-5605/1



68-5612/4/P/E + 484023
68-4403/1/A

listino prezzi movida



tabella prezzi finiture	pag. 22
info tecniche	pag. 23
indice / index	pag. 25
lavabo	pag. 29
bidet	pag. 32
doccia incasso	pag. 33
deviatori incasso	pag. 34
doccia incasso termostatico	pag. 35
doccia complementi	pag. 36
doccia esterno	pag. 37
vasca	pag. 38
bagno complementi	pag. 39
accessori rubinetteria	pag. 40

PREZZO FINITURE

Calcola il prezzo di listino (IVA esclusa) delle finiture diverse dal cromato, consultando la seguente tabella.

Moltiplicare il **PREZZO LISTINO** per il **COEFFICIENTE MOLTIPLICATORE** della finitura scelta, arrotondando per difetto il prezzo ottenuto (eliminare i centesimi).
ESEMPIO per ordinare art. 5605/S in finitura dorato: codice **04-5605/S**

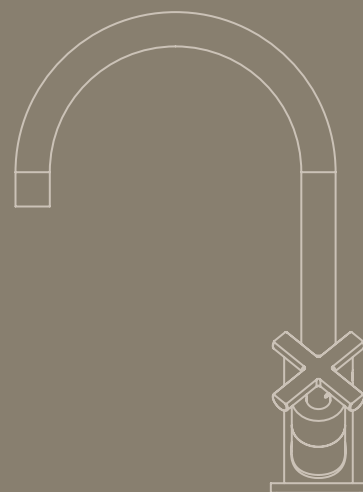
PRICE FINISHES

Include the list price (excluding VAT) of different finishes from chrome, consulting the following table. **Multiply the PRICE LIST MULTIPLIER COEFFICIENT** of the chosen finish, reducing the price obtained by deleting the centesim.

EXAMPLE to order art. 5605/S gold finish: code **04-5605/S**

COMPOSIZIONE CODICE PER ORDINARE ARTICOLO IN FINITURA



CODICE FINITURA
FINISH CODE

CODICE ARTICOLO
ITEM NUMBER

FINITURE DI SERIE / STANDARD FINISHES

COD. CODE	DESCRIZIONE FINITURA FINISH DESCRIPTION	MOLTIPLICATORE MULTIPLIER
01-	cromato / chrome	PREZZO LISTINO°

FINITURE A RICHIESTA / ON REQUEST FINISHES

COD. CODE	DESCRIZIONE FINITURA FINISH DESCRIPTION	1° GRUPPO	2° GRUPPO	3° GRUPPO	4° GRUPPO
02-	cromo/oro / chrome/gold				
03-	oro/argento / gold/silver				
04-	dorato / gold				
05-	bronzo satinato / satin bronze				
06-	rame vecchio / old copper				
07-	vecchio argento / old silver				
08-	canna di fucile / gun barrel				
10-	verderame / verdigris				
11-	nero antracite / anthracite black				
12-	ottone lucido / polished brass				
13-	ottone naturale / natural brass				
14-	bianco / white				
19-	nero / black				
28-	nickel satinato / satin nickel				
30-	nickel lucido / polished nickel				
33-	cromo satinato / satin chrome				
34-	cromo spazzolato / brushing chrome				
35-	nickel spazzolato / brushing nickel				
56-	avorio / ivory				
57-	azzurro / light blue				

FINITURE A RICHIESTA / ON REQUEST FINISHES

COD. CODE	DESCRIZIONE FINITURA FINISH DESCRIPTION	1° GRUPPO	2° GRUPPO	3° GRUPPO	4° GRUPPO
58-	verdino / light green				
59-	marrone / brown				
60-	arancio / orange				
61-	rosso / red				
66-	bianco opaco / mat white				
67-	nero opaco / matt black				
68-	rame opaco / matt copper				
69-	argento opaco / matt silver				
71-	oro opaco / matt gold				
72-	bronzo opaco / matt bronze				
75-	dorato spazzolato / brushing gold				
87-	oro rosa / pink gold				
88-	ottone sisal / sisal brass				
89-	industrial				
92-	pomice opaco / matt pumice				
93-	arenaria opaco / matt sandstone				
94-	tuscany spazzolato / brushing tuscany				
95-	rame acidato / etched copper				
96-	cemento opaco / matt cement				
A1-	brina opaco / matt frost				
A2-	tuscany cerato / oilskin tuscany				
A3-	ottone acidato / etched brass				
A4-	basalto opaco / matt basalt				

°PREZZO DI LISTINO / PRICE LIST

ATTENZIONE! 13-OTTONE NATURALE e 88-OTTONE SISAL: finiture non protette che antichizzano naturalmente ossidando a contatto con l'umidità atmosferica.
WARNING! 13-NATURAL BRASS and 88-SISAL BRASS: unprotected finishes that naturally oxidise in contact with atmospheric humidity.

(!) PER LE FINITURE E I RELATIVI MOLTIPLICATORI DEI CODICI RICAMBI CONSULTARE IL LISTINO RICAMBI O CONTATTARE IL REFERENTE COMMERCIALE.
 (!) FOR THE FINISHES AND RELATIVE MULTIPLIERS OF SPARE PARTS CODES, CONSULT THE SPARE PARTS PRICE LIST OR CONTACT THE SALE REFERENT.

ELENCO ARTICOLI SUDDIVISI PER CATEGORIA MOLTIPLICATORI FINITURE:

1° GRUPPO

- 5605/4/B/S
- 5605/2/B/S
- 5605/S
- 5605/P/S
- 564012
- 564013
- 564014
- 5605/1
- 564009
- 564010
- 564011
- 5605/6/E
- 5605/6/1/E
- 5605/3/B/E
- 5605/3/C/E
- 5605/R/B/E
- 5605/1/B
- 5607/4/S
- 5607/2/S
- 5607/S
- 5600/3/E
- 5621/E
- 5600/E
- 5603/2/1/E
- 5603/3/1/E
- 5603/4/1/E
- 5612/P/E
- 5612/2/P/E
- 5612/3/P/E
- 5612/4/P/E
- 5609/1
- 5609/4
- 5609/5/1
- 5601/A
- 5601/2/A
- 5640/E
- 5632/2/E
- 5608/E

2° GRUPPO

- 464008
- 464014
- 464003
- 4603

3° GRUPPO

- 4403/1/A
- 4630
- 4630/1

4° GRUPPO

- 0133/L
- 0136/U
- 020
- 029

RISPARMIO IDRICO

Per il risparmio idrico, tutte le bocche lavabo hanno aeratori con portata del flusso a 5 lt/min, sostituibili con aeratori di portata superiore qualora la bocca di erogazione venga utilizzata per il riempimento vasca.

SAVING WATER

For the saving water, all the basin spout have aerator with flow rate at 5lt/min, interchangeable with more flow rate aerator, in the case of using spout for fill up the bath.

CONSIGLIO TECNICO

Tutti i miscelatori della collezione MOVIDA vengono collaudati nel loro funzionamento al momento dell'assemblaggio. Per garantire la durata delle cartucce nel tempo, si consiglia di spurgare bene l'impianto idraulico prima del montaggio (per rimuovere eventuali detriti) e di installare rubinetti sottolavabo con filtro (art. 020)

N.B.: Qualora il piano lavabo avesse uno spessore superiore a 4 cm specificare la misura al momento dell'ordine.

TECHNICAL ADVICE

All mixers of the MOVIDA collection are perfectly tested. To guarantee the perfect functionality of the cartridge for a long time, we advise to clean the sanitary plant before installing the mixer. Moreover we advise to install angle valve with filter (art. 020).

Attention: If the lavatory top is more than cm 4 thick, please point it out when placing the order.

FORATURA DEI PIANI SANITARI

I miscelatori lavabo/bidet monoforo prevedono un foro di diametro 35 mm nel piano sanitario. Le batterie lavabo 3 fori sono dotate di vitone ceramico destro con apertura a 1/4 di giro (90°); l'interasse consigliato è di 110 mm e foratura come da schema.

DRILLING PLANS HEALTH

The sink / hole bidet mixers provide a hole diameter of 35 mm in the health plan. The sink batteries 3 holes are equipped with ceramic cartridge Right-open 1/4 turn (90°); the recommended distance is 110 mm, drilling as per the diagram.

MONOFORO >>
ONE HOLE >>

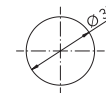

3 FORI >>
3 HOLES >>

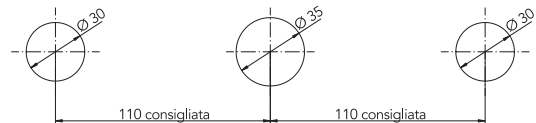

SCHEMA DI FUNZIONAMENTO MANIGLIA MISCELATORE DA PIANO E INCASSO
SCHEME ABOUT WORKING WAY HANDLE FOR STANDING AND BUILT-IN MIXER

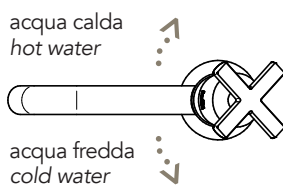
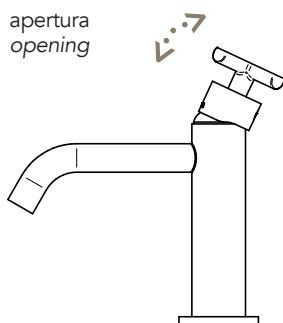

SCHEMA FUNZIONAMENTO DEVIATORI INCASSO 2/3/4 USCITE

Questi deviatori non hanno funzione di chiusura. Ruotando verso destra o sinistra si attivano le uscite. Tra 2 uscite adiacenti durante la rotazione diminuisce la portata dell'uscita iniziale ed incrementa quella della successiva. In posizione intermedia sono entrambe attive a pari portata.

SCHEME OPERATION SWITCHES FLUSH OUTPUT 2/3/4

These diverters have not closing function. By turning to the right or left activates the outputs. Between two adjacent outputs during the rotation decreases the initial output flow and increases that of the next. In position intermediate are both active at the same flow rate.

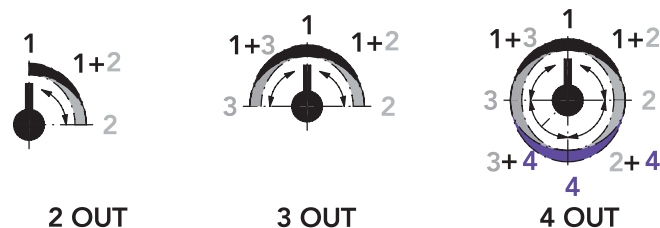

Le finiture d'autore Bellosta sono il risultato dell'artigianalità della produzione italiana della nostra azienda: eventuali differenze di tonalità non sono da considerarsi difetto, ma caratteristica di unicità del prodotto.

Bellosta color finishes are the resulted of an handcrafted italian production of our firm: any eventual difference of shade, are not to consider like a defect, but like a unique featuring of the product.

GARANZIA FINITURE

Si ricorda che la Garanzia sulle finiture DECADE nel momento in cui manutenzione e pulizia NON vengano effettuate in modo adeguato e continuativo.

FINISHINGS WARRANTY

Please note that the Warranty on finishes DECAY when maintenance and cleaning NOT be made adequately and continuously.

MANUTENZIONE E PULIZIA

Asciugare sempre con un panno morbido immediatamente dopo l'uso. Non utilizzare mai detersivi, agenti chimici, spugne abrasive, pagliette metalliche, alcool, che danneggerebbero irrimediabilmente le superfici del prodotto. Pulire esclusivamente con sapone neutro, abbondante acqua asciugare con panno morbido.

MANTENAINCE AND CLEANING

Always dry with a soft cloth immediately after use. Never use detergents, chemicals, abrasive sponges, scouring pads, alcohol, which could cause irreparable damage to the product surfaces. Clean only with natural/fresh soap, plenty of water and dry with a soft cloth.

LEGENDA SIMBOLI

**ACCESSORI
ACCESSORIES**



SCARICO C/TAPPO A PRESSIONE

WASTE WITH PRESSURE CAP

**RICAMBI IMMEDIATI
IMMEDIATE PARTS**



CARTUCCIA CARTRIDGE



CARTUCCIA DEVIATRICE DIVERTER CARTRIDGE



CARTUCCIA TERMOSTATICA THERMOSTATIC CARTRIDGE



DEVIATORE DIVERTER



VITONE CERAMICO CERAMIC VALVE



AERATORE TONDO ROUND AERATOR



VITONE TRADIZIONALE TRADITIONAL VALVE

LAVABO



5605/4/B/S pag. 29
 BATTERIA LAVABO TRE FORI BOCCA GIREVOLE
 3 HOLE BASIN SWINGING SPOUT



5605/2/B/S pag. 29
 GRUPPO LAVABO MONOFORO BOCCA GIREVOLE
 BASIN GROUP SWINGING SPOUT



564009, 564010, 564011 pag. 29
 PROLUNGHE MONOFORO LAVABO
 EXTENSIONS FOR BASIN

altezza mm 50 / high 50 mm: 564009
 altezza mm 100 / high 100 mm: 564010
 altezza mm 150 / high 150 mm: 564011



5605/S pag. 29
 MISCELATORE LAVABO MONOFORO
 BASIN MIXER



5605/P/S pag. 30
 MISCELATORE LAVABO MONOFORO BOCCA
 PROLUNGATA
 BASIN MIXER EXTENDED SPOUT



564012, 564013, 564014 pag. 30
 PROLUNGHE MISCELATORE LAVABO
 EXTENSIONS FOR BASIN

altezza mm 50 / high 50 mm: 564012
 altezza mm 100 / high 100 mm: 564013
 altezza mm 150 / high 150 mm: 564014



5605/1 pag. 30
 MISCELATORE LAVABO MONOFORO ALTO BOCCA
 PROLUNGATA
 HIGHER BASIN MIXER EXTENDED SPOUT



5605/6/E + 054061 pag. 30
 GRUPPO LAVABO A PARETE BOCCA PROLUNGATA
 WALL BASIN MOUNTED GROUP EXTENDED SPOUT

parti esterne / external parts: 5605/6/E
 parte incasso / built-in part: 054061



5605/6/1/E + 054061 pag. 31
 GRUPPO LAVABO A PARETE BOCCA EXTRA
 PROLUNGATA
 WALL BASIN MOUNTED GROUP EXTRA EXTENDED
 SPOUT

parti esterne / external parts: 5605/6/1/E
 parte incasso / built-in part: 054061



5605/3/B/E + 894001 pag. 31
 MISCELATORE LAVABO DA PARETE BOCCA
 PROLUNGATA
 WALL BASIN EXTENDED SPOUT MIXER

parti esterne / external parts: 5605/3/B/E
 parte incasso / built-in part: 894001



5605/3/C/E + 894001 pag. 31
 MISCELATORE LAVABO DA PARETE BOCCA EXTRA
 PROLUNGATA
 WALL BASIN EXTRA EXTENDED SPOUT MIXER

parti esterne / external parts: 5605/3/C/E
 parte incasso / built-in part: 894001



5605/R/B/E + 104033 pag. 31
 MISCELATORE INCASSO REMOTO
 BUILT-IN REMOTE MIXER

parti esterne / external parts: 5605/R/B/E
 parte incasso / built-in part: 104033



464008 pag. 32
 BOCCA LAVABO DA PARETE L 185
 WALL WASH SPOUT L 185



464014 pag. 32
 BOCCA LAVABO DA PARETE L 215
 WALL WASH SPOUT L 215



5605/1/B pag. 32
 BOCCA MONOFORO GIREVOLE
 SWINGING WASH SPOUT

BIDET

5607/4/S pag. 32



BATTERIA BIDET TRE FORI BOCCA GIREVOLE
3 HOLE BIDET SWINGING SPOUT

5607/2/S pag. 33



GRUPPO BIDET MONOFORO BOCCA GIREVOLE
BIDET GROUP SWINGING SPOUT

5607/S pag. 33



MISCELATORE BIDET MONOFORO
BIDET MIXER

464003 pag. 33



BOCCA BIDET DA PARETE
WALL BIDET SPOUT

DOCCIA INCASSO

5600/3/E + 054059 pag. 33



GRUPPO INCASSO C/DEVIATORE 2 USCITE
BUILT-IN GROUP WITH DIVERTER 2 OUT

parti esterne / external parts: 5600/3/E
parte incasso / built-in part: 054059

5621/E + 104018 pag. 34



MISCELATORE INCASSO
BUILT-IN MIXER

parti esterne / external parts: 5621/E
parte incasso / built-in part: 104018

5600/E + 104002 pag. 34



MISCELATORE INCASSO C/DEVIATORE 2 USCITE
BUILT-IN MIXER WITH DIVERTER 2 OUT

parti esterne / external parts: 5600/E
parte incasso / built-in part: 104002

DEVIATORI INCASSO

5603/2/1/E + 914016 pag. 34



DEVIATORE INCASSO 2 USCITE
BUILT-IN DIVERTER 2 OUT

parti esterne / external parts: 5603/2/1/E
parte incasso / built-in part: 914016

5603/3/1/E + 034127 pag. 34



DEVIATORE INCASSO 3 USCITE
BUILT-IN DIVERTER 3 OUT

parti esterne / external parts: 5603/3/1/E
parte incasso / built-in part: 034127

5603/4/1/E + 034128 pag. 35



DEVIATORE INCASSO 4 USCITE
BUILT-IN DIVERTER 4 OUT

parti esterne / external parts: 5603/4/1/E
parte incasso / built-in part: 034128

DOCCIA INCASSO TERMOSTATICO

5612/P/E + 484020 pag. 35



MISCELATORE TERMOSTATICO INCASSO 1 USCITA
BUILT-IN THERMOSTATIC MIXER 1 OUT

parti esterne / external parts: 5612/P/E
parte incasso / built-in part: 484020

5612/2/P/E + 484021 pag. 35



MISCELATORE TERMOSTATICO INCASSO
C/DEVIATORE 2 USCITE
BUILT-IN THERMOSTATIC MIXER WITH DIVERTER 2 OUT

parti esterne / external parts: 5612/2/P/E
parte incasso / built-in part: 484021

5612/3/P/E + 484022 pag. 35



MISCELATORE TERMOSTATICO INCASSO
C/DEVIATORE 3 USCITE
BUILT-IN THERMOSTATIC MIXER WITH DIVERTER
3 OUT

parti esterne / external parts: 5612/3/P/E
parte incasso / built-in part: 484022

5612/4/P/E + 484023 pag. 36



MISCELATORE TERMOSTATICO INCASSO
C/DEVIATORE 4 USCITE
BUILT-IN THERMOSTATIC MIXER WITH DIVERTER
4 OUT

parti esterne / external parts: 5612/4/P/E
parte incasso / built-in part: 484023

DOCCIA COMPLEMENTI



4403/1/A pag. **36**
 SUPPORTO DOCCIA COMPLETO
 FULL SHOWER SUPPORT



4630 pag. **36**
 SALISCENDI COMPLETO C/PRESA D'ACQUA
 COMPLETE WALL PIPE WITH WATER CONNECTION



4630/1 pag. **37**
 ASTA SALISCENDI
 WALL PIPE

DOCCIA ESTERNO



5609/1 pag. **37**
 GRUPPO DOCCIA ESTERNO
 EXTERNAL SHOWER GROUP



5609/4 pag. **37**
 GRUPPO DOCCIA ESTERNO C/STELO
 EXTERNAL SHOWER GROUP WITH PIPE



5609/5/1 pag. **38**
 GRUPPO DOCCIA ESTERNO C/STELO COMPLETO
 EXTERNAL SHOWER GROUP WITH COMPLETE PIPE

VASCA



5601/A pag. **38**
 GRUPPO VASCA ESTERNO
 EXTERNAL BATH GROUP



5601/2/A pag. **38**
 BATTERIA PER BORDO VASCA
 BATH RIM



4603 pag. **38**
 BOCCA VASCA DA PARETE
 WALL BATH SPOUT

BAGNO COMPLEMENTI



5608/E + 054025 pag. **39**
 RUBINETTO D'ARRESTO 1/2"
 BUILT-IN STOP COCK 1/2"



parti esterne / external parts: 5608/E
 parte incasso / built-in part: 054025



5608/E + 054027 pag. **39**
 RUBINETTO D'ARRESTO 3/4"
 BUILT-IN STOP COCK 3/4"



parti esterne / external parts: 5608/E
 built-in part: 054027



5640/E + 654099 pag. **39**
 PASSO RAPIDO 3/4"
 BUILT-IN RAPID FLOW COCK 3/4"



parti esterne / external parts: 5640/E
 parte incasso / built-in part: 654099



5640/E + 654100 pag. **39**
 PASSO RAPIDO 1"
 BUILT-IN RAPID FLOW COCK 1"



parti esterne / external parts: 5640/E
 parte incasso / built-in part: 654100

BAGNO COMPLEMENTI



5632/2/E + 035212 pag. **40**

SARACINESCA
GATE VALVE



parti esterne / external parts: 5632/2/E
parte incasso / built-in part: 035212

ACCESSORI RUBINETTERIA



0133/L pag. **40**

SIFONE LAVABO A BOTTIGLIA HI TECH 1"1/4
ONE WAY BOTTLE "HI TECH" SIPHON TRAP FOR
WASHBASIN 1"1/4



0136/U pag. **40**

SCARICO UNIVERSALE TONDO STOP&GO 1"1/4
ALL-PURPOSE ROUND POP-UP WASTE 1"1/4



020 pag. **40**

RUBINETTO SOTTOLAVABO CON FILTRO
ANGLE VALVE WITH FILTER



029 pag. **41**

TUBETTO CON CALOTTA 1/2"F
PIPE WITH NUT 1/2"F

5605/4/B/S



BATTERIA LAVABO 3 FORI BOCCA ALTA GIREVOLE

- > vitone ceramico 90°
- > interasse bocca 150
- > bocca girevole 360°
- > limitatore di portata 5 l/min 3bar
- > senza flessibili di alimentazione
- > senza scarico

0136/U
cromato €
p. 40

055001
€
p. 151 - list. ricambi

454038
€
p. 141 - list. ricambi

CROMATO

01-5605/4/B/S €

ALTRE FINITURE

XX-5605/4/B/S €

>> LISTINO PREZZI PRESSO RIVENDITORI AUTORIZZATI

5605/2/B/S

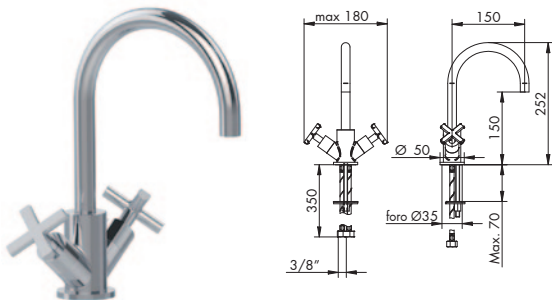

GRUPPO LAVABO MONOFORO BOCCA GIREVOLE

- > vitone ceramico 90°
- > interasse bocca 150
- > bocca girevole 360°
- > limitatore di portata 5 l/min 3bar
- > flessibili di alimentazione
- > senza scarico

0136/U
cromato €
p. 40

055001
€
p. 151 - list. ricambi

454038
€
p. 141 - list. ricambi

CROMATO

01-5605/2/B/S €

ALTRE FINITURE

XX-5605/2/B/S €

>> LISTINO PREZZI PRESSO RIVENDITORI AUTORIZZATI

564009 | 564010 | 564011

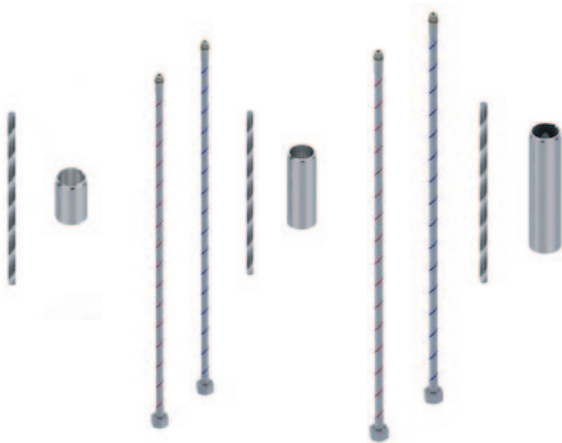

PROLUNGHE MONOFORO LAVABO

- > diametro 36 mm
- > altezza 50 mm, 100 mm, 150 mm

CROMATO

01-564009 50 mm €
01-564010 100 mm €
01-564011 150 mm €

ALTRE FINITURE

XX-564009 €
XX-564010 €
XX-564011 €

>> LISTINO PREZZI PRESSO RIVENDITORI AUTORIZZATI

5605/S

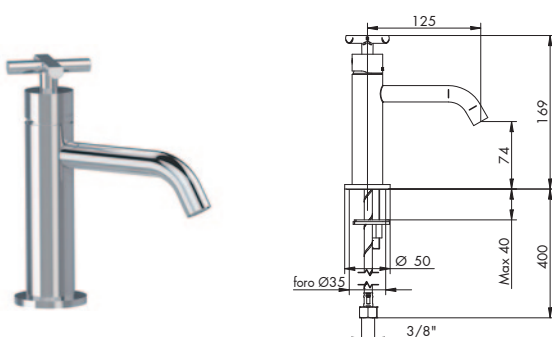

MISCELATORE LAVABO MONOFORO

- > cartuccia tradizionale
- > interasse bocca 125
- > limitatore di portata 5 l/min 3bar
- > flessibili di alimentazione
- > senza scarico

0136/U
cromato €
p. 40

455039
€
p. 150 - list. ricambi

454038
€
p. 141 - list. ricambi

CROMATO

01-5605/S €

ALTRE FINITURE

XX-5605/S €

>> LISTINO PREZZI PRESSO RIVENDITORI AUTORIZZATI

ACCESSORI CONSIGLIATI RICAMBI IMMEDIATI

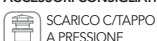

SCARICO C/TAPPO A PRESSIONE



CARTUCCIA



AERATORE TONDO



VITONE CERAMICO

XX = CODICE FINITURA RICHIESTA: per identificare codice corretto vedi pag. 22
M* = MOLTIPLICATORE: per calcolare il prezzo delle altre finiture vedi tabella pag. 22

5605/P/S

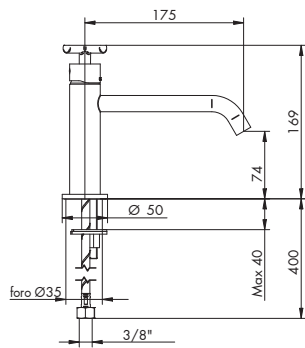

MISCELATORE LAVABO MONOFORO BOCCA PROLUNGATA

- > cartuccia tradizionale
- > interasse bocca 175
- > limitatore di portata 5 l/min 3bar
- > flessibili di alimentazione
- > senza scarico

	0136/U cromato € p. 40
	455039 € p. 150 - list. ricambi
	454038 € p. 141 - list. ricambi

CROMATO

01-5605/P/S

€

ALTRE FINITURE

XX-5605/P/S

€

>> LISTINO PREZZI PRESSO RIVENDITORI AUTORIZZATI

564012 | 564013 | 564014

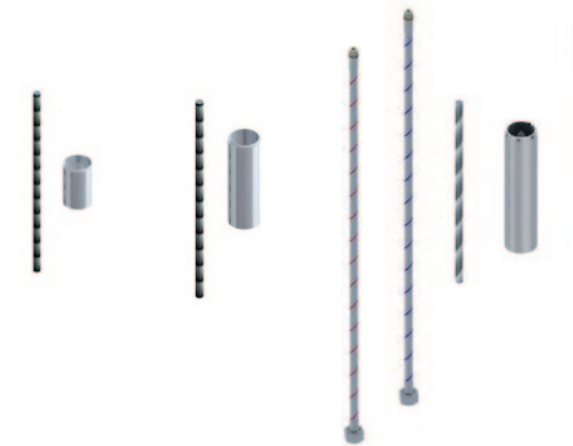

PROLUNGHE MISCELATORE LAVABO

- > diametro 34 mm
- > altezza 50 mm, 100 mm, 150 mm

CROMATO

01-564012	50 mm	€
01-564013	100 mm	€
01-564014	150 mm	€

ALTRE FINITURE

XX-564012	50 mm	€	x M*
XX-564013	100 mm	€	x M*
XX-564014	150 mm	€	x M*

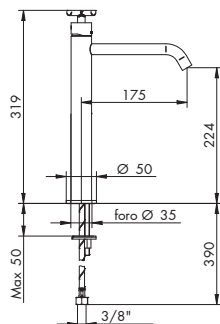

>> LISTINO PREZZI PRESSO RIVENDITORI AUTORIZZATI

5605/1



MISCELATORE LAVABO MONOFORO ALTO BOCCA PROLUNGATA

- > cartuccia tradizionale
- > interasse bocca 175
- > limitatore di portata 5 l/min 3bar
- > flessibili di alimentazione
- > senza scarico

	0136/U cromato € p. 40
	455039 € p. 150 - list. ricambi
	454038 € p. 141 - list. ricambi

CROMATO

01-5605/1

€

ALTRE FINITURE

XX-5605/1

€

>> LISTINO PREZZI PRESSO RIVENDITORI AUTORIZZATI

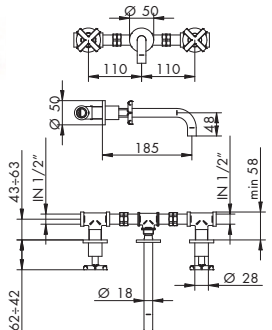

5605/6/E + 054061

[parte esterna] [parte incasso]



GRUPPO LAVABO DA PARETE BOCCA PROLUNGATA

- > vitone ceramico 90°
- > interasse bocca 185
- > limitatore di portata 5 l/min 3bar
- > ingressi da 1/2"
- > senza scarico

	0136/U cromato € p. 40
	055001 € p. 151 - list. ricambi
	454038 € p. 141 - list. ricambi

PARTI ESTERNE - CROMATO

01-5605/6/E

€

PARTI ESTERNE - ALTRE FINITURE

XX-5605/6/E

€

x M*

PARTE INCASSO

054061

€

PREZZO TOTALE

€

>> LISTINO PREZZI PRESSO RIVENDITORI AUTORIZZATI

5605/6/1/E + 054061

[parte esterna] [parte incasso]

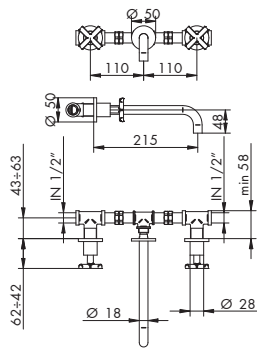
**GRUPPO LAVABO DA PARETE BOCCA EXTRA PROLUNGATA**

- > vitone ceramico 90°
- > interasse bocca 215
- > limitatore di portata 5 l/min 3bar
- > ingressi da 1/2"
- > senza scarico

0136/U
cromato €
p. 40055001
€

p. 151 - list. ricambi

454038
€

p. 141 - list. ricambi

PARTI ESTERNE - CROMATO

01-5605/6/1/E €

PARTI ESTERNE - ALTRE FINITURE

XX- 5605/6/1/E € x M*

PARTE INCASSO

054061 €

PREZZO TOTALE €**>> LISTINO PREZZI PRESSO RIVENDITORI AUTORIZZATI****5605/3/B/E + 894001**

[parte esterna] [parte incasso]

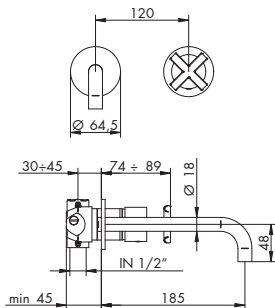
**MISCELATORE LAVABO DA PARETE BOCCA PROLUNGATA**

- > cartuccia tradizionale
- > interasse bocca 185
- > limitatore di portata 5l/min 3bar
- > ingressi da 1/2"
- > senza scarico
- > rosoni separati

0136/U
cromato €
p. 40025002
€

p. 149 - list. ricambi

454038
€

p. 141 - list. ricambi

PARTI ESTERNE - CROMATO

01-5605/3/B/E €

PARTI ESTERNE - ALTRE FINITURE

XX- 5605/3/B/E € x M*

PARTE INCASSO

01-894001 €

PREZZO TOTALE €**>> LISTINO PREZZI PRESSO RIVENDITORI AUTORIZZATI****5605/3/C/E + 894001**

[parte esterna] [parte incasso]

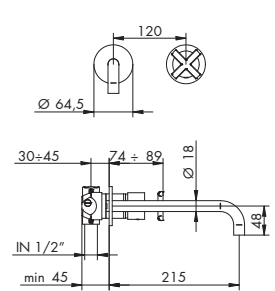
**MISCELATORE LAVABO DA PARETE BOCCA EXTRA PROLUNGATA**

- > cartuccia tradizionale
- > interasse bocca 215
- > limitatore di portata 5l/min 3bar
- > ingressi da 1/2"
- > senza scarico
- > rosoni separati

0136/U
cromato €
p. 40025002
€

p. 149 - list. ricambi

454038
€

p. 141 - list. ricambi

PARTI ESTERNE - CROMATO

01-5605/3/C/E €

PARTI ESTERNE - ALTRE FINITURE

XX- 5605/3/C/E € x M*

PARTE INCASSO

01-894001 €

PREZZO TOTALE €**>> LISTINO PREZZI PRESSO RIVENDITORI AUTORIZZATI****5605/R/B/E + 104033**

[parte esterna] [parte incasso]

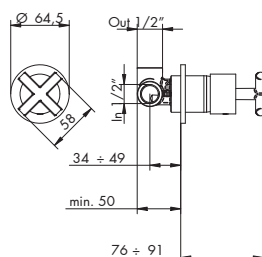
**MISCELATORE INCASSO REMOTO**

- > cartuccia tradizionale
- > ingressi da 1/2"
- > uscita superiore
- > senza scarico

0136/U
cromato €
p. 40025002
€

p. 149 - list. ricambi

PARTI ESTERNE - CROMATO

01-5605/R/B/E €

PARTI ESTERNE - ALTRE FINITURE

XX- 5605/R/B/E € x M*

PARTE INCASSO

01-104033 €

PREZZO TOTALE €**>> LISTINO PREZZI PRESSO RIVENDITORI AUTORIZZATI**

ACCESSORI CONSIGLIATI RICAMBI IMMEDIATI

SCARICO C/TAPPO
A PRESSIONE

CARTUCCIA

AERATORE
TONDOVITONE
CERAMICOXX = CODICE FINITURA RICHIESTA: per identificare codice corretto vedi pag. 22
M* = MOLTIPLICATORE: per calcolare il prezzo delle altre finiture vedi tabella pag. 22

464008

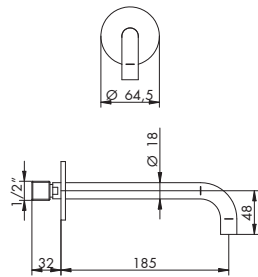

BOCCA LAVABO DA PARETE

- > interasse bocca 185
- > limitatore di portata 5 l/min 3 bar
- > attacco da 1/2"
- > rosone tondo

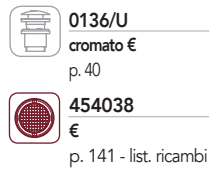

CROMATO

01-464008

€

ALTRE FINITURE

XX-464008

€

x M*

>> LISTINO PREZZI PRESSO RIVENDITORI AUTORIZZATI

464014

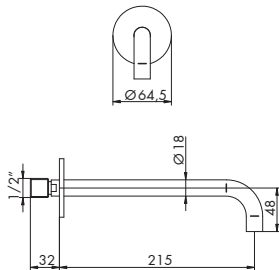

BOCCA LAVABO DA PARETE

- > interasse bocca 215
- > limitatore di portata 5 l/min 3 bar
- > attacco da 1/2"
- > rosone tondo



CROMATO

01-464014

€

ALTRE FINITURE

XX-464014

€

x M*

>> LISTINO PREZZI PRESSO RIVENDITORI AUTORIZZATI

5605/1/B

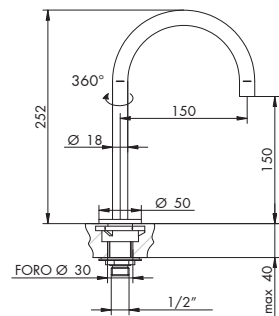

BOCCA MONOFORO GIREVOLE

- > interasse bocca 150
- > bocca girevole 360°
- > limitatore di portata 5 l/min 3bar
- > attacco da 1/2"



CROMATO

01-5605/1/B

€

ALTRE FINITURE

XX-5605/1/B

€

x M*

>> LISTINO PREZZI PRESSO RIVENDITORI AUTORIZZATI

5607/4/S

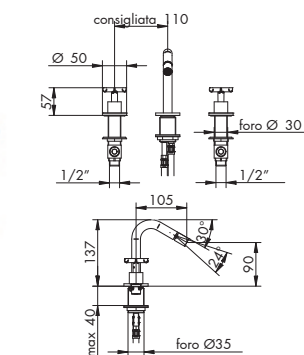

BATTERIA BIDET 3 FORI BOCCA GIREVOLE

- > vitone ceramico 90°
- > interasse bocca 105
- > bocca girevole 360°
- > limitatore di portata 5 l/min 3 Bar
- > aeratore snodato
- > senza flessibili di alimentazione
- > senza scarico



CROMATO

01-5607/4/S

€

ALTRE FINITURE

XX-5607/4/S

€

>> LISTINO PREZZI PRESSO RIVENDITORI AUTORIZZATI

5607/2/S

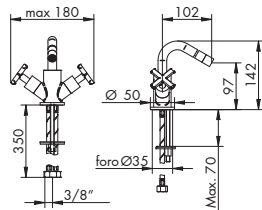

GRUPPO BIDET MONOFORO BOCCA GIREVOLE

- > vitone ceramico 90°
- > interasse bocca 102
- > bocca girevole 360°
- > aeratore snodato
- > flessibili di alimentazione
- > senza scarico

- 0136/U cromato € p. 40
- 055001 € p. 151 - list. ricambi
- 054031 cromato € p. 140 - list. ricambi

CROMATO	
01-5607/2/S	€

ALTRE FINITURE	
XX-5607/2/S	€

>> LISTINO PREZZI PRESSO RIVENDITORI AUTORIZZATI

5607/S

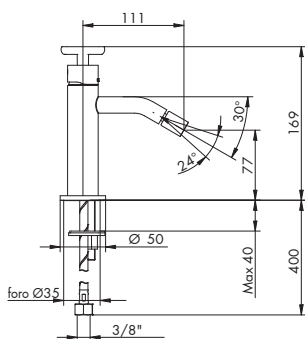

MISCELATORE BIDET MONOFORO

- > cartuccia tradizionale
- > interasse bocca 111
- > aeratore snodato
- > limitatore di portata 5 l/min 3 Bar
- > flessibili di alimentazione
- > senza scarico

- 0136/U cromato € p. 40
- 455039 € p. 150 - list. ricambi
- 454038 € p. 141 - list. ricambi

CROMATO	
01-5607/S	€

ALTRE FINITURE	
XX-5607/S	€

>> LISTINO PREZZI PRESSO RIVENDITORI AUTORIZZATI

464003

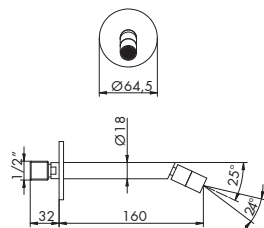

BOCCA BIDET DA PARETE

- > interasse bocca 160
- > aeratore snodato
- > attacco da 1/2"
- > rosone tondo

- 0136/U cromato € p. 40
- 014076 cromato € p. 140 - list. ricambi

CROMATO	
01-464003	€

ALTRE FINITURE	
XX-464003	€ x M*

>> LISTINO PREZZI PRESSO RIVENDITORI AUTORIZZATI

5600/3/E + 054059

[parte esterna] [parte incasso]

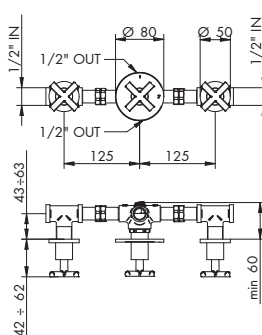

GRUPPO INCASSO C/DEVIATORE 2 USCITE

- > vitone ceramico 90°
- > deviatore a dischi ceramici 2 uscite senza chiusura
- > attacchi da 1/2"

- 055001 € p. 151 - list. ricambi
- 635010 € p. 131 - list. ricambi

PARTI ESTERNE - CROMATO	
01-5600/3/E	€

PARTI ESTERNE - ALTRE FINITURE	
XX-5600/3/E	€ x M*

PARTE INCASSO	
054059	€

PREZZO TOTALE	
	€

>> LISTINO PREZZI PRESSO RIVENDITORI AUTORIZZATI

5621/E + 104018

[parte esterna] [parte incasso]

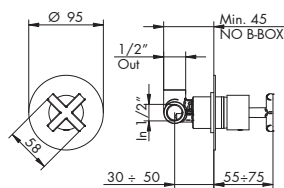

MISCELATORE INCASSO

- > cartuccia tradizionale
- > ingressi da 1/2"
- > uscita superiore
- > incasso con B-Box



025002
€
p. 149 - list. ricambi

PARTI ESTERNE - CROMATO

01-5621/E €

PARTI ESTERNE - ALTRE FINITURE

XX- 5621/E € x M*

PARTE INCASSO

01-104018 €

PREZZO TOTALE €

>> LISTINO PREZZI PRESSO RIVENDITORI AUTORIZZATI

5600/E + 104002

[parte esterna] [parte incasso]

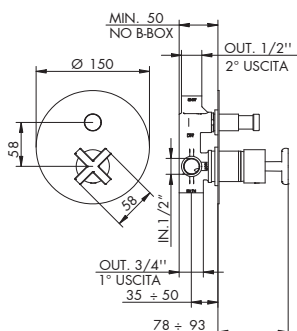

MISCELATORE INCASSO C/DEVIATORE 2 USCITE

- > cartuccia tradizionale
- > deviatore a pressione 2 uscite c/ritorno automatico e blocco meccanico basse pressioni
- > attacchi da 1/2"
- > uscita principale inferiore da 3/4"
- > incasso con B-Box



025002
€
p. 149 - list. ricambi



105029
€
p. 131 - list. ricambi

PARTI ESTERNE - CROMATO

01-5600/E €

PARTI ESTERNE - ALTRE FINITURE

XX- 5600/E € x M*

PARTE INCASSO

01-104002 €

PREZZO TOTALE €

>> LISTINO PREZZI PRESSO RIVENDITORI AUTORIZZATI

5603/2/1/E + 914016

[parte esterna] [parte incasso]

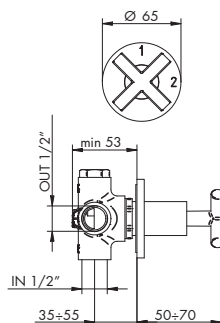

DEVIATORE INCASSO 2 USCITE

- > deviatore a dischi ceramici 2 uscite senza chiusura
- > attacchi da 1/2"



635010
€
p. 131 - list. ricambi

PARTI ESTERNE - CROMATO

01-5603/2/1/E €

PARTI ESTERNE - ALTRE FINITURE

XX- 5603/2/1/E € x M*

PARTE INCASSO

914016 €

PREZZO TOTALE €

>> LISTINO PREZZI PRESSO RIVENDITORI AUTORIZZATI

5603/3/1/E + 034127

[parte esterna] [parte incasso]

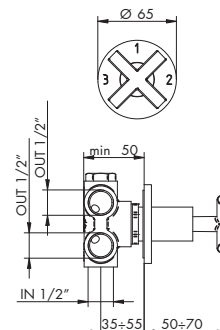

DEVIATORE INCASSO 3 USCITE

- > deviatore a dischi ceramici 3 uscite senza chiusura
- > attacchi da 1/2"



635011
€
p. 131 - list. ricambi

PARTI ESTERNE - CROMATO

01-5603/3/1/E €

PARTI ESTERNE - ALTRE FINITURE

XX- 5603/3/1/E € x M*

PARTE INCASSO

034127 €

PREZZO TOTALE €

>> LISTINO PREZZI PRESSO RIVENDITORI AUTORIZZATI



CARTUCCIA DEVIATRICE



DEVIATORE



CARTUCCIA

5603/4/1/E + 034128

[parte esterna] [parte incasso]

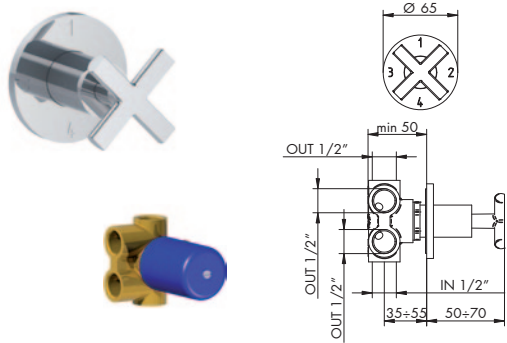

DEVIATORE INCASSO 4 USCITE

> deviatore a dischi ceramici 4 uscite senza chiusura
> attacchi da 1/2"

635012
€
p. 131 - list. ricambi

PARTI ESTERNE - CROMATO		PARTI ESTERNE - ALTRE FINITURE	
01-5603/4/1/E	€	XX- 5603/4/1/E	€ x M*
PARTE INCASSO			
034128	€		
PREZZO TOTALE	€		

>> LISTINO PREZZI PRESSO RIVENDITORI AUTORIZZATI

5612/P/E + 484020

[parte esterna] [parte incasso]

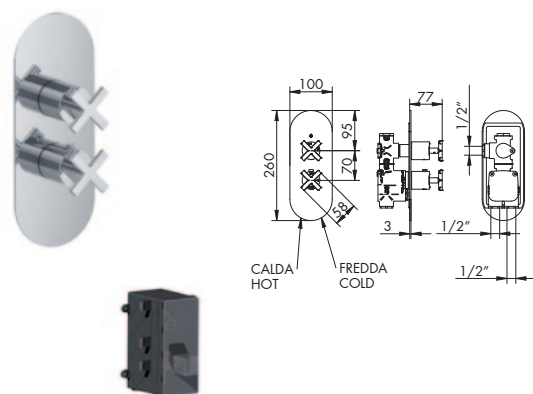

MISCELATORE TERMOSTATICO INCASSO 1 USCITA

> cartuccia termostatica
> vitone ceramico 90°
> apertura con rotazione antioraria
> interasse 70 mm
> ingressi inferiori da 1/2" > uscita laterale destra da 1/2"
> incasso con B-Box > incasso regolabile min 76
> posizionabile orizzontalmente > piastra unica
> 2 maniglie

775007
€
p. 220 - list. ricambi

055134
€
p. 220 - list. ricambi

PARTI ESTERNE - CROMATO		PARTI ESTERNE - ALTRE FINITURE	
01-5612/P/E	€	XX- 5612/P/E	€ x M*
PARTE INCASSO			
484020	€		
PREZZO TOTALE	€		

>> LISTINO PREZZI PRESSO RIVENDITORI AUTORIZZATI

5612/2/P/E + 484021

[parte esterna] [parte incasso]

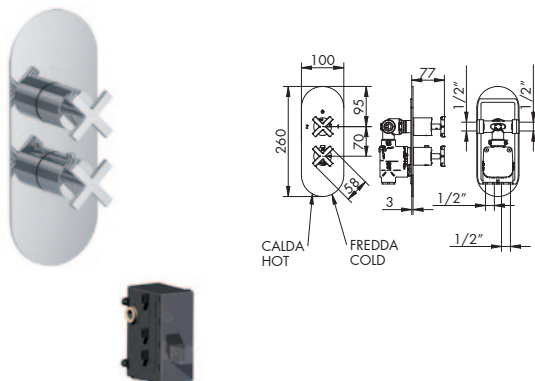

MISCELATORE TERMOSTATICO INCASSO C/DEVIATORE 2 USCITE

> cartuccia termostatica
> deviatore a dischi ceramici 2 uscite c/chiusura
> interasse 70 mm
> ingressi inferiori da 1/2" > uscite laterali da 1/2"
> incasso con B-Box > incasso regolabile min 76
> piastra unica
> 2 maniglie

775007
€
p. 220 - list. ricambi

035346
€
p. 212 - list. ricambi

PARTI ESTERNE - CROMATO		PARTI ESTERNE - ALTRE FINITURE	
01-5612/2/P/E	€	XX- 5612/2/P/E	€ x M*
PARTE INCASSO			
484021	€		
PREZZO TOTALE	€		

>> LISTINO PREZZI PRESSO RIVENDITORI AUTORIZZATI

5612/3/P/E + 484022

[parte esterna] [parte incasso]

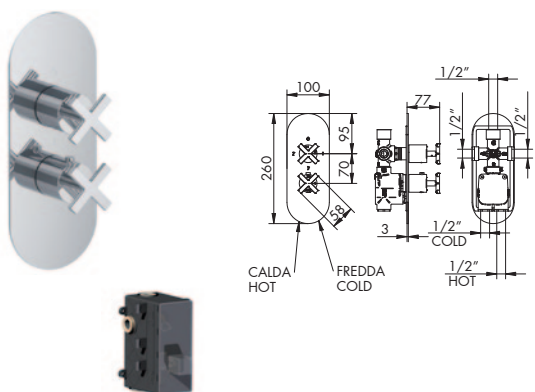

MISCELATORE TERMOSTATICO INCASSO C/DEVIATORE 3 USCITE

> cartuccia termostatica
> deviatore a dischi ceramici 3 uscite c/chiusura
> interasse 70 mm
> ingressi inferiori da 1/2" > uscite laterali e superiore da 1/2"
> incasso con B-Box > incasso regolabile min 76
> piastra unica > 2 maniglie

775007
€
p. 220 - list. ricambi

035345
€
p. 212 - list. ricambi

PARTI ESTERNE - CROMATO		PARTI ESTERNE - ALTRE FINITURE	
01-5612/3/P/E	€	XX- 5612/3/P/E	€ x M*
PARTE INCASSO			
484022	€		
PREZZO TOTALE	€		

>> LISTINO PREZZI PRESSO RIVENDITORI AUTORIZZATI

RICAMBI IMMEDIATI

- CARTUCCIA TERMOSTATICA
- CARTUCCIA DEVIATRICE
- VITONE CERAMICO

XX = CODICE FINITURA RICHIESTA: per identificare codice corretto vedi pag. 22
M* = MOLTIPLICATORE: per calcolare il prezzo delle altre finiture vedi tabella pag. 22

5612/4/P/E + 484023

[parte esterna]

[parte incasso]

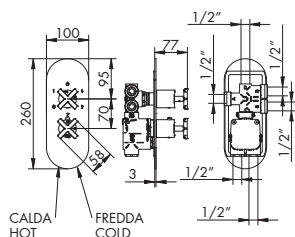

MISCELATORE TERMOSTATICO INCASSO C/DEVIATORE 4 USCITE

- > cartuccia termostatica
- > deviatore a dischi ceramici 4 uscite c/doppia chiusura
- > interasse 70 mm
- > ingressi inferiori da 1/2"
- > uscite laterali e superiore da 1/2"
- > incasso in ottone con B-Box
- > piastra unica

775007
€
p. 220 - list. ricambi

035344
€
p. 212 - list. ricambi

PARTI ESTERNE - CROMATO

01-5612/4/P/E €

PARTI ESTERNE - ALTRE FINITURE

XX- 5612/4/P/E € x M*

PARTE INCASSO

484023 €

PREZZO TOTALE €

>> LISTINO PREZZI PRESSO RIVENDITORI AUTORIZZATI

PER COMANDI TERMOSTATICI ALTA PORTATA, CONSULTARE
LISTINO REVIVRE DA PAG. 187.

FOR HIGH FLOW RATE THERMOSTATIC MIXER, LOOK AT THE
"REVIVRE" PRICE LIST FROM PAGE 187.

8812/H/P/E
+ 7740358812/2H/P/E
+ 7740368812/3H/P/E
+ 7740338812/4H/P/E
+ 7740348812/H/E
+ 8840368812/2H/E
+ 8840378812/3H/E
+ 8840388812/4H/E
+ 884039

4403/1/A

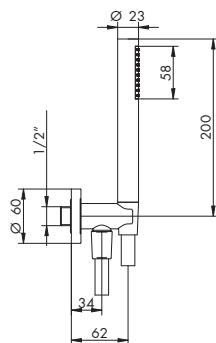

SUPPORTO DOCCIA COMPLETO

- > flessibile in PVC 150 cm
- > presa acqua con supporto fisso
- > attacchi da 1/2"
- > doccetta monogetto cilindrica in abs c/anticalcare
- > per finiture diverse da cromo doccetta in metallo

CROMATO

01-4403/1/A €

ALTRE FINITURE

XX-4403/1/A € x M*

>> LISTINO PREZZI PRESSO RIVENDITORI AUTORIZZATI

4630

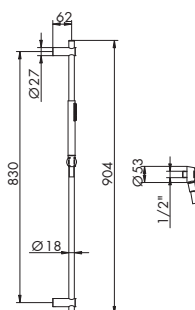

SALISCENDI COMPLETO C/PRESA D'ACQUA

- > flessibile in PVC 150 cm
- > supporto doccetta scorrevole orientabile
- > presa acqua da 1/2"
- > doccetta monogetto cilindrica in ABS c/anticalcare, per finiture diverse da cromo doccetta in metallo

CROMATO

01-4630 €

ALTRE FINITURE

XX-4630 € x M*

>> LISTINO PREZZI PRESSO RIVENDITORI AUTORIZZATI

4630/1

ASTA SALISCENDI

> supporto doccetta scorrevole orientabile

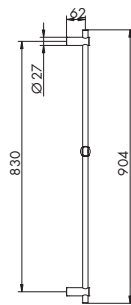

CROMATO

01-4630/1

€

ALTRE FINITURE

XX-4630/1

€

x M*

>> LISTINO PREZZI PRESSO RIVENDITORI AUTORIZZATI

PER SOLUZIONI ALTERNATIVE, CONSULTARE LISTINO REVIVRE DA PAG. 119, SEZIONE COMPLETA DOCCIA COMPLEMENTI.

FOR ALTERNATIVE SOLUTIONS, SEE THE REVIVRE PRICE LIST FROM PAGE 119, TO LOOK AT THE COMPLETE "DOCCIA COMPLEMENTI" COLLECTION.

PER COMPOSIZIONI DOCCIA CONSULTARE LISTINO REVIVRE.

FOR SHOWER TYPESETTING LOOK AT "REVIVRE" PRICE LIST.

5609/1

GRUPPO DOCCIA ESTERNO

> vitone ceramico 90°
> senza set doccia
> attacchi da 1/2"



055001

€

p. 151 - list. ricambi

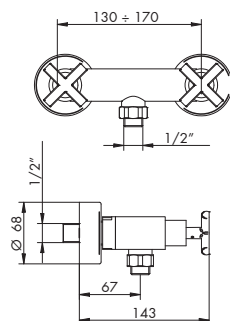

CROMATO

01-5609/1

€

ALTRE FINITURE

XX-5609/1

€

>> LISTINO PREZZI PRESSO RIVENDITORI AUTORIZZATI

5609/4

GRUPPO DOCCIA ESTERNO C/STELO

> vitone ceramico 90°
> stelo regolabile
> stelo regolabile
> soffione Ø200 in ABS con anticalcare, per finiture diverse da cromo soffione in metallo
> attacchi da 1/2"



055001

€

p. 151 - list. ricambi

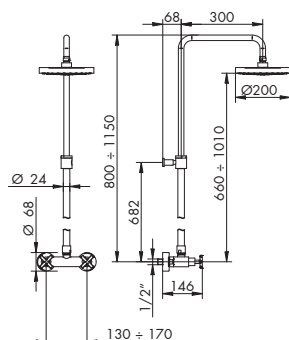

CROMATO

01-5609/4

€

ALTRE FINITURE

XX-5609/4

€

>> LISTINO PREZZI PRESSO RIVENDITORI AUTORIZZATI

RICAMBI IMMEDIATI

VITONE
CERAMICO

XX = CODICE FINITURA RICHIESTA: per identificare codice corretto vedi pag. 22
M* = MOLTIPLICATORE: per calcolare il prezzo delle altre finiture vedi tabella pag. 22

5609/5/1

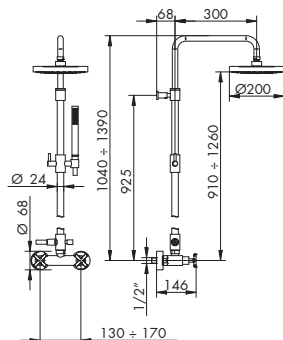

GRUPPO DOCCIA ESTERNO C/STELO COMPLETO

- > vitone ceramico 90°
- > stelo regolabile
- > deviatore a trazione c/ritorno automatico e blocco meccanico bassa pressione
- > soffione orientabile Ø200 in ABS c/anticalcare
- > flessibile in PVC 150 cm
- > supporto doccetta scorrevole
- > attacchi da 1/2"
- > doccetta monogetto cilindrica in ABS c/anticalcare
- > per finiture diverse da cromo doccetta e soffione in metallo

 **055001**
€
p. 151 - list. ricambi

 **045073**
cromato €
p. 131 - list. ricambi

CROMATO

01-5609/5/1

€

ALTRE FINITURE

XX-5609/5/1

€

>> LISTINO PREZZI PRESSO RIVENDITORI AUTORIZZATI

5601/A

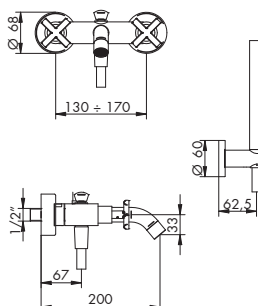

GRUPPO VASCA ESTERNO

- > vitone ceramico 90°
- > interasse bocca 200
- > deviatore a trazione c/ritorno automatico e blocco meccanico per basse pressioni
- > flessibile in PVC 150 cm
- > supporto fisso
- > attacchi da 1/2"
- > doccetta monogetto cilindrica in ABS c/anticalcare, per finiture diverse da cromo doccetta in metallo

 **055001**
€
p. 151 - list. ricambi

 **014072**
cromato €
p. 130 - list. ricambi

CROMATO

01-5601/A

€

ALTRE FINITURE

XX-5601/A

€

>> LISTINO PREZZI PRESSO RIVENDITORI AUTORIZZATI

5601/2/A

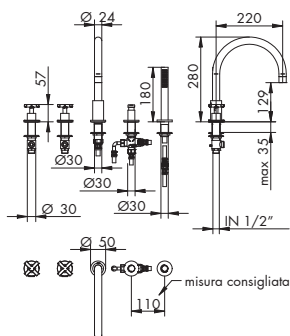

BATTERIA PER BORDO VASCA

- > vitone ceramico 90°
- > interasse bocca 220
- > deviatore a pressione c/ritorno automatico e blocco meccanico per basse pressioni
- > flessibile in PVC 150 cm
- > senza flessibili di alimentazione
- > senza scarico
- > doccetta monogetto cilindrica in ABS c/anticalcare, per finiture diverse da cromo doccetta in metallo
- > PREDISPOSIZIONI per bordo vasca, art. 012/5, 012/6 e 012/7, vedi pag. 615 - listino Rubinetteria

 **055001**
€
p. 151 - list. ricambi

 **724030**
€
p. 132 - list. ricambi

 **014074**
cromato €
p. 140 - list. ricambi

CROMATO

01-5601/2/A

€

ALTRE FINITURE

XX-5601/2/A

€

>> LISTINO PREZZI PRESSO RIVENDITORI AUTORIZZATI

4603

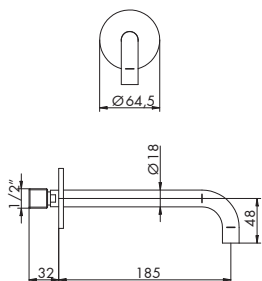

BOCCA VASCA DA PARETE

- > interasse bocca 185
- > attacchi da 1/2"

 **254003**
€
p. 141 - list. ricambi

CROMATO

01-4603

€

ALTRE FINITURE

XX-4603

€

x M*

>> LISTINO PREZZI PRESSO RIVENDITORI AUTORIZZATI

5608/E + 054025

[parte esterna] [parte incasso]

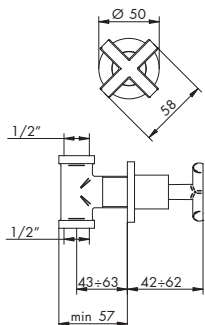

RUBINETTO D'ARRESTO 1/2"

> vitone ceramico 90°
> ingressi da 1/2"

 055001
€ 2

p. 151 - list. ricambi

PARTI ESTERNE - CROMATO

01-5608/E €

PARTI ESTERNE - ALTRE FINITURE

XX- 5608/E € x M*

PARTE INCASSO

054025 €

PREZZO TOTALE €

>> LISTINO PREZZI PRESSO RIVENDITORI AUTORIZZATI

5608/E + 054027

[parte esterna] [parte incasso]

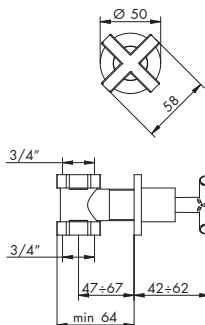

RUBINETTO D'ARRESTO 3/4"

> vitone ceramico 90°
> ingressi da 3/4"

 055001
€ 2

p. 151 - list. ricambi

PARTI ESTERNE - CROMATO

01-5608/E €

PARTI ESTERNE - ALTRE FINITURE

XX- 5608/E € x M*

PARTE INCASSO

054027 €

PREZZO TOTALE €

>> LISTINO PREZZI PRESSO RIVENDITORI AUTORIZZATI

5640/E + 654099

[parte esterna] [parte incasso]

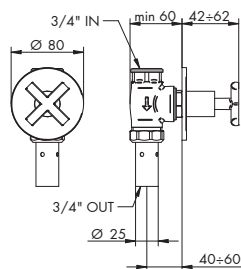

PASSO RAPIDO 3/4"

> vitone tradizionale
> abbinare a saracinesca
> ingressi da 3/4"

 654067
€ .

p. 151 - list. ricambi

PARTI ESTERNE - CROMATO

01-5640/E €

PARTI ESTERNE - ALTRE FINITURE

XX- 5640/E € x M*

PARTE INCASSO

654099 €

PREZZO TOTALE €

>> LISTINO PREZZI PRESSO RIVENDITORI AUTORIZZATI

5640/E + 654100

[parte esterna] [parte incasso]

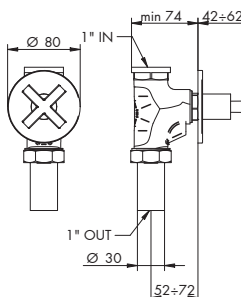

PASSO RAPIDO 1"

> vitone tradizionale
> abbinare a saracinesca
> ingressi da 1"

 654067
€ .

p. 151 - list. ricambi

PARTI ESTERNE - CROMATO

01-5640/E €

PARTI ESTERNE - ALTRE FINITURE

XX- 5640/E € x M*

PARTE INCASSO

654100 €

PREZZO TOTALE €

>> LISTINO PREZZI PRESSO RIVENDITORI AUTORIZZATI

RICAMBI IMMEDIATI



XX = CODICE FINITURA RICHIESTA: per identificare codice corretto vedi pag. 22
M* = MOLTIPLICATORE: per calcolare il prezzo delle altre finiture vedi tabella pag. 22

5632/2/E + 035212

[parte esterna] [parte incasso]

SARACINESCA

> attacchi da 3/4"

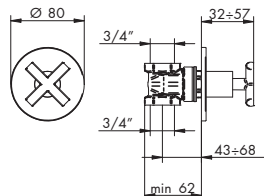

PARTI ESTERNE - CROMATO	
01-5632/2/E	€
PARTE INCASSO	
035212	€
PREZZO TOTALE	
	€

PARTI ESTERNE - ALTRE FINITURE	
XX- 5632/2/E	€ x M*

>> LISTINO PREZZI PRESSO RIVENDITORI AUTORIZZATI

0133/L

SIFONE LAVABO A BOTTIGLIA HI TECH 1"1/4

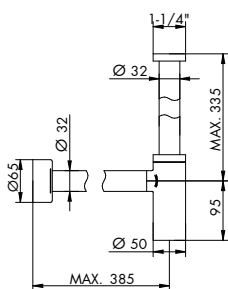

CROMATO	
01-0133/L	€

ALTRE FINITURE	
XX-0133/L	€ x M*

>> LISTINO PREZZI PRESSO RIVENDITORI AUTORIZZATI

0136/U

SCARICO UNIVERSALE TONDO STOP&GO 1"1/4

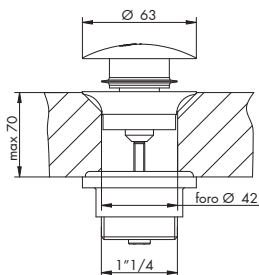

CROMATO	
01-0136/U	€

ALTRE FINITURE	
XX-0136/U	€ x M*

>> LISTINO PREZZI PRESSO RIVENDITORI AUTORIZZATI

020

RUBINETTO SOTTOLAVABO CON FILTRO

> attacco a parete da 1/2"
 > per collegamento flessibili 3/8" o tubetti Ø10
 > filtro interno per raccolta macro impurità

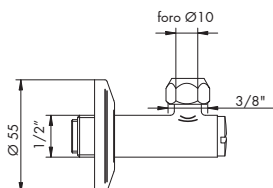

CROMATO	
01-020	€

ALTRE FINITURE	
XX-020	€ x M*

>> LISTINO PREZZI PRESSO RIVENDITORI AUTORIZZATI

029

TUBETTO CON CALOTTA 1/2" F

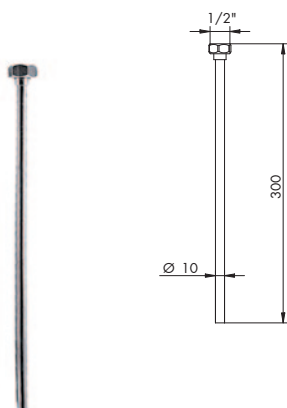

CROMATO		ALTRE FINITURE	
01-029	€	XX-029	€ x M*

>> LISTINO PREZZI PRESSO RIVENDITORI AUTORIZZATI

PER SOLUZIONI ALTERNATIVE, CONSULTARE LISTINO RUBINETTERIA DA PAG. 707, SEZIONE COMPLETA ACCESSORI RUBINETTERIA.

FOR ALTERNATIVE SOLUTIONS, SEE THE "RUBINETTERIA" PRICE LIST FROM PAGE 707, TO LOOK AT THE COMPLETE "ACCESSORI RUBINETTERIA" COLLECTION.

PROGETTO SU MISURA: RICHIESTE SPECIALI

I tecnici di Bellosta Rubinetterie sono, inoltre, a disposizione di architetti e designers, per offrire un servizio esclusivo: personalizzazioni di elementi in funzione di specifiche richieste estetiche o problematiche legate a vincoli progettuali, verifica della fattibilità attraverso opportuni studi CAD e sviluppo del disegno tecnico del prodotto speciale richiesto.

Per informazioni e richieste PROGETTI SU MISURA:
ufficiotecnico@bellostarubinetterie.com

PROGETTO SU MISURA: SPECIAL REQUESTS

Engineers Bellosta Rubinetterie are also available to architects and designers, to offer an exclusive service: customizations of items according to specific aesthetic requirements or issues related to design constraints, verification of the feasibility studies and development through appropriate CAD technical design the required special product. For information and requests "SU MISURA" PROJECTS:
ufficiotecnico@bellostarubinetterie.com

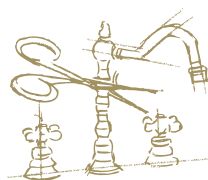

progetto
"sumisura."

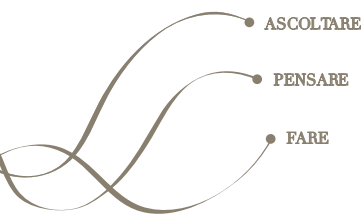

ASCOLTARE, PENSARE, FARE è la formula che abbiamo scelto per descrivere l'attenzione con cui interpretiamo i desideri del cliente, elaboriamo soluzioni ed esprimiamo proposte che ne soddisfino i gusti e le esigenze. Con lo stesso spirito, con lo stesso entusiasmo, oggi come oltre cinquantotto anni fa.

LISTEN, THINK, ACT is the philosophy that we use to describe the attention by which we interpret the wishing of the client, we find solution and make proposal for meet the taste and exigent. With the same mind and passion, today like more than fifty-eight years ago.

© 2020 Bellosta Rubinetterie. Tutti i diritti riservati.

GRAPHIC:
Roberta Teruggi

CONCEPT:
aCB

BELLOSTA CARLO & C. RUBINETTERIE Srl
Via S. Botticelli, 12/14 | 28024 Briga Novarese (No) Italia
Ingresso showroom: Largo Carlo Bellosta | Briga Novarese (No) Italia
Atelier Milano: Via Montenapoleone, 22
Atelier Roma: Piazza di Spagna, ingresso Via Gregoriana 23

T +39 0322 956 425 | 0322 912 330 | 0322 946 84
F +39 0322 955 368 | info@bellostarubinetterie.com
Export department: estero@bellostarubinetterie.com

Follow us on facebook, youTube, linked in, twitter, pinterest, instagram, houzz

Visit our website on bellostarubinetterie.com

SPECIAL THANKS TO:
Florim | www.florim.com