

listino prezzi fabrique



tabella prezzi finiture	pag. 26
info tecniche	pag. 26
indice / index	pag. 28
lavabo	pag. 32
bidet	pag. 36
doccia incasso	pag. 36
deviatori incasso	pag. 37
doccia incasso termostatico	pag. 38
doccia complementi	pag. 39
doccia esterno	pag. 40
vasca	pag. 40
bagno complementi	pag. 41
accessori rubinetteria	pag. 42

PREZZO FINITURE

Calcola il prezzo di listino (IVA esclusa) delle finiture diverse dal cromato, consultando la seguente tabella.

Moltiplicare il **PREZZO LISTINO** per il **COEFFICIENTE MOLTIPLICATORE** della finitura scelta, arrotondando per difetto il prezzo ottenuto (eliminare i centesimi).
ESEMPIO per ordinare art. 4705/S in finitura dorato con maniglia nero opaco: codice **04-4705/S + 67-476001**

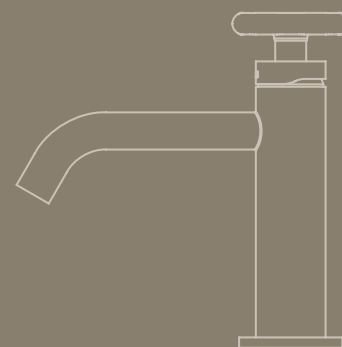
€ 194,00 (PREZZO LISTINO MIX) x 2,15 (MOLTIPLICATORE)	= € 417,10 417,00
€ 58,00 (PREZZO LISTINO MANIGLIA) x 1,45 (MOLTIPLICATORE)	= € 84,10 84,00
€ 417,00 + € 84,00 = € 501,00 PREZZO TOTALE	

PRICE FINISHES

Include the list price (excluding VAT) of different finishes from chrome, consulting the following table. Multiply the **PRICE LIST MULTIPLIER COEFFICIENT** of the chosen finish, reducing the price obtained by deleting the centesim. **EXAMPLE** to order art. 4705/S gold finish with matt black handle: code **04-4705/S + 67-476001**

€ 194,00 (MIX PRICE LIST) x 2,15 (MULTIPLIER)	= € 417,10 417,00
€ 58,00 (HANDLE PRICE LIST) x 1,45 (MULTIPLIER)	= € 84,10 84,00
€ 417,00 + € 84,00 = € 501,00 TOTAL PRICE	

COMPOSIZIONE CODICE PER ORDINARE ARTICOLO IN FINITURA



FINITURE DI SERIE / STANDARD FINISHES

COD. CODE	DESCRIZIONE FINITURA FINISH DESCRIPTION	MOLTIPLICATORE MULTIPLIER
01-	cromato / chrome	PREZZO LISTINO°

FINITURE A RICHIESTA / ON REQUEST FINISHES

COD. CODE	DESCRIZIONE FINITURA FINISH DESCRIPTION	1° GRUPPO	2° GRUPPO	3° GRUPPO
02-	cromo/oro / chrome/gold	x 1,50	x 1,50	x 1,50
03-	oro/argento / gold/silver	x 1,65	x 1,75	x 1,75
04-	dorato / gold	x 2,15	x 2,20	x 2,25
05-	bronzo satinato / satin bronze	x 1,65	x 1,75	x 1,70
06-	rame vecchio / old copper	x 1,65	x 1,75	x 1,70
07-	vecchio argento / old silver	x 1,65	x 1,75	x 1,70
08-	canna di fucile / gun barrel	x 2,15	x 2,20	x 2,25
10-	verderame / verdigris	x 2,15	x 2,20	x 2,30
11-	nero antracite / anthracite black	x 2,15	x 2,20	x 2,25
12-	ottone lucido / polished brass	x 1,50	x 1,50	x 1,45
13-	ottone naturale / natural brass	x 1,30	x 1,30	x 1,20
14-	bianco / white	x 1,45	x 1,45	x 1,40
19-	nero / black	x 1,45	x 1,45	x 1,45
28-	nickel satinato / satin nickel	x 1,65	x 1,75	x 1,75
30-	nickel lucido / polished nickel	x 1,65	x 1,75	x 1,75
33-	cromo satinato / satin chrome	x 1,65	x 1,75	x 1,70
34-	cromo spazzolato / brushing chrome	x 1,70	x 1,80	x 1,80
35-	nickel spazzolato / brushing nickel	x 1,65	x 1,75	x 1,70
56-	avorio / ivory	x 1,65	x 1,75	x 1,75
57-	azzurro / light blue	x 1,65	x 1,75	x 1,75

FINITURE A RICHIESTA / ON REQUEST FINISHES

COD. CODE	DESCRIZIONE FINITURA FINISH DESCRIPTION	1° GRUPPO	2° GRUPPO	3° GRUPPO
58-	verdino / light green	x 1,65	x 1,75	x 1,75
59-	marrone / brown	x 1,65	x 1,75	x 1,75
60-	arancio / orange	x 1,65	x 1,75	x 1,75
61-	rosso / red	x 1,65	x 1,75	x 1,75
66-	bianco opaco / mat white	x 1,45	x 1,45	x 1,40
67-	nero opaco / matt black	x 1,45	x 1,45	x 1,40
68-	rame opaco / matt copper	x 1,65	x 1,75	x 1,75
69-	argento opaco / matt silver	x 1,65	x 1,75	x 1,70
71-	oro opaco / matt gold	x 2,15	x 2,20	x 2,25
72-	bronzo opaco / matt bronze	x 1,65	x 1,75	x 1,75
75-	dorato spazzolato / brushing gold	x 2,30	x 2,40	x 2,40
87-	oro rosa / pink gold	x 2,30	x 2,40	x 2,45
88-	ottone sisal / sisal brass	x 1,50	x 1,50	x 1,50
89-	industrial	x 2,15	x 2,20	x 2,30
92-	pomice opaco / matt pumice	x 1,85	x 1,90	x 1,90
93-	arenaria opaco / matt sandstone	x 1,85	x 1,90	x 1,90
94-	tuscany spazzolato / brushing tuscany	x 1,85	x 1,90	x 1,90
95-	rame acidato / etched copper	x 2,15	x 2,20	x 2,30
96-	cemento opaco / matt cement	x 1,85	x 1,90	x 1,90
A1-	brina opaco / matt frost	x 1,85	x 1,90	x 1,90
A2-	tuscany cerato / oilskin tuscany	x 1,85	x 1,90	x 1,90
A3-	ottone acidato / etched brass	x 2,15	x 2,20	x 2,30
A4-	basalto opaco / matt basalt	x 1,85	x 1,90	x 1,90
B1-	rosso "fabrique" / "fabrique" red	x 1,45	x 1,45	x 1,45

°PREZZO DI LISTINO / PRICE LIST

ATTENZIONE! 13-OTTONE NATURALE e 88-OTTONE SISAL: finiture non protette che antichizzano naturalmente ossidando a contatto con l'umidità atmosferica.
WARNING! 13-NATURAL BRASS and 88-SISAL BRASS: unprotected finishes that naturally oxidise in contact with atmospheric humidity.

(!) PER LE FINITURE E I RELATIVI MOLTIPLICATORI DEI CODICI RICAMBI CONSULTARE IL LISTINO RICAMBI O CONTATTARE IL REFERENTE COMMERCIALE.
 (!) FOR THE FINISHES AND RELATIVE MULTIPLIERS OF SPARE PARTS CODES, CONSULT THE SPARE PARTS PRICE LIST OR CONTACT THE SALE REFERENT.

ELENCO ARTICOLI SUDDIVISI PER CATEGORIA MOLTIPLICATORI FINITURE:

1° GRUPPO

- 4705/S
- 4705/P/S
- 444014
- 444015
- 444016
- 4705/1
- 4705/4/BS
- 4705/3/BE
- 4705/3/CE
- 4705/3/2E
- 4705/3/3E
- 4705/6/E
- 4705/6/1E
- 4705/R/A
- 4705/R/BE
- 464008
- 464014
- 4705/1/B

2° GRUPPO

- 4403/1/A
- 0530N
- 0530/1N

3° GRUPPO

- 0133/L
- 0136/U
- 020
- 029

RISPARMIO IDRICO

Per il risparmio idrico, tutte le bocche lavabo e bidet hanno aeratori con portata del flusso a 5 lt/min, sostituibili con aeratori di portata superiore qualora la bocca di erogazione venga utilizzata per il riempimento vasca.

SAVING WATER

For the saving water, all the basin and bidet spout have aerator with flow rate at 5lt/min, interchangeable with more flow rate aerator, in the case of using spout for fill up the bath.

CONSIGLIO TECNICO

Tutti i miscelatori della collezione FABRIQUE vengono collaudati nel loro funzionamento al momento dell'assemblaggio. Per garantire la durata delle cartucce nel tempo, si consiglia di spurgare bene l'impianto idraulico prima del montaggio (per rimuovere eventuali detriti) e di installare rubinetti sottolavabo con filtro (art. 020)

N.B.: Qualora il piano lavabo avesse uno spessore superiore a 4 cm specificare la misura al momento dell'ordine.

TECHNICAL ADVICE

All mixers of the FABRIQUE collection are perfectly tested. To guarantee the perfect functionality of the cartridge for a long time, we advise to clean the sanitary plant before installing the mixer. Moreover we advise to install angle valve with filter (art. 020).

Attention: If the lavatory top is more than cm 4 thick, please point it out when placing the order.

FORATURA DEI PIANI SANITARI

I miscelatori lavabo/bidet monoforo prevedono un foro di diametro 35 mm nel piano sanitario. Le batterie lavabo 3 fori sono dotate di vitone ceramico destro con apertura a 1/4 di giro (90°); l'interasse consigliato è di 110 mm e foratura come da schema.

DRILLING PLANS HEALTH

The sink / hole bidet mixers provide a hole diameter of 35 mm in the health plan. The sink batteries 3 holes are equipped with ceramic cartridge Right-open 1/4 turn (90°); the recommended distance is 110 mm, drilling as per the diagram.

MONOFORO >>
ONE HOLE >>

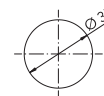

3 FORI >>
3 HOLES >>

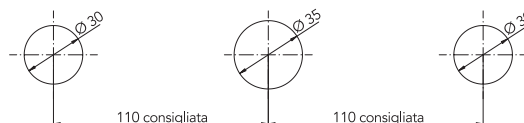

SCHEMA DI FUNZIONAMENTO MANIGLIA MISCELATORE DA PIANO E INCASSO
SCHEME ABOUT WORKING WAY HANDLE FOR STANDING AND BUILT-IN MIXER

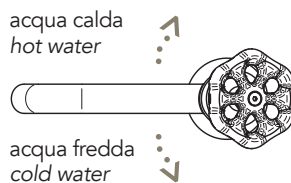
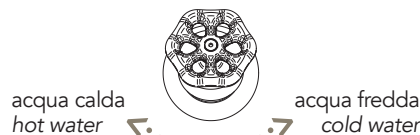
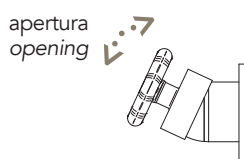
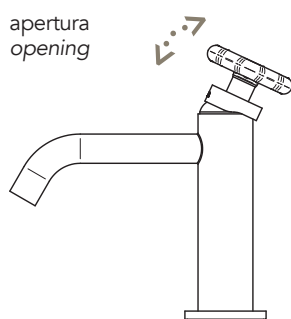

SCHEMA FUNZIONAMENTO DEVIATORI INCASSO 2/3/4 USCITE

Questi deviatori non hanno funzione di chiusura. Ruotando verso destra o sinistra si attivano le uscite. Tra 2 uscite adiacenti durante la rotazione diminuisce la portata dell'uscita iniziale ed incrementa quella della successiva. In posizione intermedia sono entrambe attive a pari portata.

SCHEME OPERATION SWITCHES FLUSH OUTPUT 2/3/4

These diverters have not closing function. By turning to the right or left activates the outputs. Between two adjacent outputs during the rotation decreases the initial output flow and increases that of the next. In position intermediate are both active at the same flow rate.

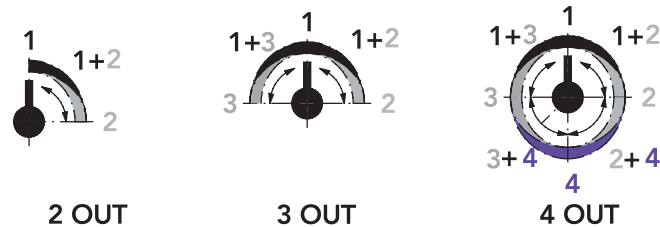

Le finiture d'autore Bellosta sono il risultato dell'artigianalità della produzione italiana della nostra azienda: eventuali differenze di tonalità non sono da considerarsi difetto, ma caratteristica di unicità del prodotto.

Bellosta color finishes are the resulted of an handcrafted italian production of our firm: any eventual difference of shade, are not to consider like a defect, but like a unique featuring of the product.

GARANZIA FINITURE

Si ricorda che la Garanzia sulle finiture DECADE nel momento in cui manutenzione e pulizia NON vengano effettuate in modo adeguato e continuativo.

FINISHINGS WARRANTY

Please note that the Warranty on finishes DECAY when maintenance and cleaning NOT be made adequately and continuously.

MANUTENZIONE E PULIZIA

Asciugare sempre con un panno morbido immediatamente dopo l'uso. Non utilizzare mai detersivi, agenti chimici, spugne abrasive, pagliette metalliche, alcool, che danneggerebbero irrimediabilmente le superfici del prodotto. Pulire esclusivamente con sapone neutro, abbondante acqua asciugare con panno morbido.

MANTENAINCE AND CLEANING

Always dry with a soft cloth immediately after use. Never use detergents, chemicals, abrasive sponges, scouring pads, alcohol, which could cause irreparable damage to the product surfaces. Clean only with natural/fresh soap, plenty of water and dry with a soft cloth.

LEGENDA SIMBOLI

**ACCESSORI
ACCESSORIES**



SCARICO C/TAPPO A PRESSIONE

WASTE WITH PRESSURE CAP

**RICAMBI IMMEDIATI
IMMEDIATE PARTS**



CARTUCCIA CARTRIDGE



CARTUCCIA DEVIATRICE DIVERTER CARTRIDGE



CARTUCCIA TERMOSTATICA THERMOSTATIC CARTRIDGE



DEVIATORE DIVERTER



VITONE CERAMICO CERAMIC VALVE



AERATORE TONDO ROUND AERATOR



VITONE TRADIZIONALE TRADITIONAL VALVE

LAVABO



4705/4/BS + 476001 pag. 32
BATTERIA LAVABO TRE FORI BOCCA GIREVOLE
3 HOLE BASIN SWINGING SPOUT



4705/S + 476001 pag. 32
MISCELATORE LAVABO MONOFORO
BASIN MIXER



4705/P/S + 476001 pag. 32
MISCELATORE LAVABO MONOFORO BOCCA
PROLUNGATA
BASIN MIXER EXTENDED SPOUT

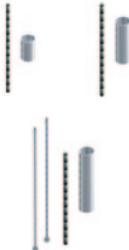

474015, 474016, 474017 pag. 32
PROLUNGHE MISCELATORE LAVABO
EXTENSIONS FOR BASIN

altezza mm 50 / high 50 mm: 474015
 altezza mm 100 / high 100 mm: 474016
 altezza mm 150 / high 150 mm: 474017



4705/1 + 476001 pag. 33
MISCELATORE LAVABO MONOFORO ALTO BOCCA
PROLUNGATA
HIGHER BASIN MIXER EXTENDED SPOUT



4705/6/E + 476001 + 054061 pag. 33
GRUPPO LAVABO A PARETE
WALL BASIN MOUNTED GROUP



parti esterne / external parts: 4705/6/E
 maniglia / handle: 476001 x 2 pz
 parte incasso / built-in part: 054061



4705/6/1E + 476001 + 054061 pag. 33
GRUPPO LAVABO A PARETE BOCCA PROLUNGATA
WALL BASIN MOUNTED GROUP EXTENDED SPOUT



parti esterne / external parts: 4705/6/1E
 maniglia / handle: 476001 x 2 pz
 parte incasso / built-in part: 054061



4705/3/BE + 476001 + 894001 pag. 33
MISCELATORE LAVABO DA PARETE BOCCA
PROLUNGATA
WALL BASIN EXTENDED SPOUT MIXER



parti esterne / external parts: 4705/3/BE
 maniglia / handle: 476001
 parte incasso / built-in part: 894001



4705/3/CE + 476001 + 894001 pag. 34
MISCELATORE LAVABO DA PARETE BOCCA EXTRA
PROLUNGATA
WALL BASIN EXTRA EXTENDED SPOUT MIXER



parti esterne / external parts: 4705/3/CE
 maniglia / handle: 476001
 parte incasso / built-in part: 894001

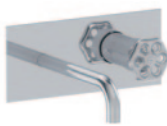

4705/3/2E + 476001 + 894001 pag. 34
MISCELATORE LAVABO DA PARETE SU PIASTRA
BOCCA PROLUNGATA
WALL BASIN MIXER EXTENDED SPOUT ON PLATE



parti esterne / external parts: 4705/3/2E
 maniglia / handle: 476001
 parte incasso / built-in part: 894001



4705/3/3E + 476001 + 894001 pag. 34
MISCELATORE LAVABO DA PARETE SU PIASTRA
BOCCA EXTRA PROLUNGATA
WALL BASIN MIXER EXTRA EXTENDED SPOUT ON
PLATE



parti esterne / external parts: 4705/3/3E
 maniglia / handle: 476001
 parte incasso / built-in part: 894001



4705/R/A + 476001 pag. 34
MISCELATORE REMOTO
REMOTE MIXER



4705/R/BE + 476001 + 104033 pag. 35
MISCELATORE INCASSO REMOTO
BUILT-IN REMOTE MIXER



parti esterne / external parts: 4705/R/BE
 maniglia / handle: 476001
 parte incasso / built-in part: 104033



464008 pag. 35
BOCCA LAVABO DA PARETE L 185
WALL WASH SPOUT L 185



464014 pag. 35
BOCCA LAVABO DA PARETE L 215
WALL WASH SPOUT L 215



4705/1/B pag. 35
BOCCA MONOFORO GIREVOLE
SWINGING WASH SPOUT

BIDET



4707/4/S + 476001 pag. 36

BATTERIA BIDET TRE FORI BOCCA GIREVOLE
3 HOLE BIDET SWINGING SPOUT



4707/S + 476001 pag. 36

MISCELATORE BIDET MONOFORO
BIDET MIXER



464003 pag. 36

BOCCA BIDET DA PARETE
WALL BIDET SPOUT

DOCCIA INCASSO



4721/E + 476001 + 104018 pag. 36

MISCELATORE INCASSO
BUILT-IN MIXER



parti esterne / external parts: 4721/E
maniglia / handle: 476001
parte incasso / built-in part: 104018



4700/E + 476001 + 104002 pag. 37

MISCELATORE INCASSO C/DEVIATORE 2 USCITE
BUILT-IN MIXER WITH DIVERTER 2 OUT



parti esterne / external parts: 4700/E
maniglia / handle: 476001
parte incasso / built-in part: 104002

DEVIATORI INCASSO



4703/2/1E + 476001 + 914016 pag. 37

DEVIATORE INCASSO 2 USCITE
BUILT-IN DIVERTER 2 OUT



parti esterne / external parts: 4703/2/1E
maniglia / handle: 476001
parte incasso / built-in part: 914016



4703/3/1E + 476001 + 034127 pag. 37

DEVIATORE INCASSO 3 USCITE
BUILT-IN DIVERTER 3 OUT



parti esterne / external parts: 4703/3/1E
maniglia / handle: 476001
parte incasso / built-in part: 034127



4703/4/1E + 476001 + 034128 pag. 37

DEVIATORE INCASSO 4 USCITE
BUILT-IN DIVERTER 4 OUT



parti esterne / external parts: 4703/4/1E
maniglia / handle: 476001
parte incasso / built-in part: 034128

DOCCIA INCASSO TERMOSTATICO



4712/PE + 476001 + 484020 pag. 38

MISCELATORE TERMOSTATICO INCASSO 1 USCITA
BUILT-IN THERMOSTATIC MIXER 1 OUT



parti esterne / external parts: 4712/PE
maniglia / handle: 476001
parte incasso / built-in part: 484020



4712/2/PE + 476001 + 484021 pag. 38

MISCELATORE TERMOSTATICO INCASSO
C/DEVIATORE 2 USCITE
BUILT-IN THERMOSTATIC MIXER WITH DIVERTER 2 OUT



parti esterne / external parts: 4712/2/PE
maniglia / handle: 476001
parte incasso / built-in part: 484021

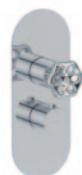

4712/3/PE + 476001 + 484022 pag. 38

MISCELATORE TERMOSTATICO INCASSO
C/DEVIATORE 3 USCITE
BUILT-IN THERMOSTATIC MIXER WITH DIVERTER
3 OUT



parti esterne / external parts: 4712/3/PE
maniglia / handle: 476001
parte incasso / built-in part: 484022



4712/4/PE + 476001 + 484023 pag. 38

MISCELATORE TERMOSTATICO INCASSO
C/DEVIATORE 4 USCITE
BUILT-IN THERMOSTATIC MIXER WITH DIVERTER
4 OUT



parti esterne / external parts: 4712/4/PE
maniglia / handle: 476001
parte incasso / built-in part: 484023

DOCCIA COMPLEMENTI



4403/1/A pag. 39

SUPPORTO DOCCIA COMPLETO
FULL SHOWER SUPPORT



0530N pag. 39

SALISCENDI COMPLETO C/PRESA D'ACQUA
COMPLETE WALL PIPE WITH WATER CONNECTION

DOCCIA COMPLEMENTI



0530/1N pag. **39**

ASTA SALISCENDI
WALL PIPE

DOCCIA ESTERNO



4709/1 + 476001 pag. **40**

MISCELATORE DOCCIA ESTERNO
EXTERNAL SHOWER MIXER

VASCA



4701/A + 476001 pag. **40**

MISCELATORE VASCA ESTERNO
EXTERNAL BATH MIXER



4603 pag. **40**

BOCCA VASCA DA PARETE
WALL BATH SPOUT

BAGNO COMPLEMENTI



4708/E + 476001 + 054025 pag. **41**

RUBINETTO D'ARRESTO 1/2"
BUILT-IN STOP COCK 1/2"

parti esterne / external parts: 4708/E
maniglia / handle: 476001
parte incasso / built-in part: 054025



4708/E + 476001 + 054027 pag. **41**

RUBINETTO D'ARRESTO 3/4"
BUILT-IN STOP COCK 3/4"

parti esterne / external parts: 4708/E
maniglia / handle: 476001
built-in part: 054027



4740/E + 476001 + 654099 pag. **41**

PASSO RAPIDO 3/4"
BUILT-IN RAPID FLOW COCK 3/4"

parti esterne / external parts: 4740/E
maniglia / handle: 476001
parte incasso / built-in part: 654099



4740/E + 476001 + 654100 pag. **41**

PASSO RAPIDO 1"
BUILT-IN RAPID FLOW COCK 1"

parti esterne / external parts: 4740/E
maniglia / handle: 476001
parte incasso / built-in part: 654100



4732/2/E + 476001 + 035212 pag. **42**

SARACINESCA
GATE VALVE

parti esterne / external parts: 4732/2/E
maniglia / handle: 476001
parte incasso / built-in part: 035212



ACCESSORI RUBINETTERIA



0133/L pag. **42**

SIFONE LAVABO A BOTTIGLIA HI TECH 1"1/4
ONE WAY BOTTLE "HI TECH" SIPHON TRAP FOR
WASHBASIN 1"1/4



0136/U pag. **42**

SCARICO UNIVERSALE TONDO STOP&GO 1"1/4
ALL-PURPOSE ROUND POP-UP WASTE 1"1/4



020 pag. **42**

RUBINETTO SOTTOLAVABO CON FILTRO
ANGLE VALVE WITH FILTER



029 pag. **43**

TUBETTO CON CALOTTA 1/2"F
PIPE WITH NUT 1/2"F

4705/4/BS + 476001

[batteria]

[maniglia]

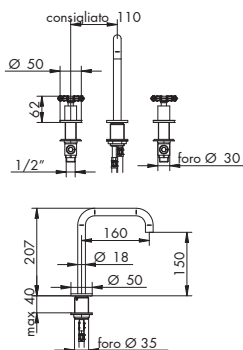

rosso B1

BATTERIA LAVABO 3 FORI BOCCA ALTA GIREVOLE

- > vitone ceramico 90°
- > interasse bocca 160
- > bocca girevole 360°
- > limitatore di portata 5 l/min 3bar
- > senza flessibili di alimentazione
- > senza scarico
- > cod. B1 = rosso fabrique

	0136/U cromato € 58,00 p. 41
	605007 € 20,00 p. 151 - list. ricambi
	454038 € 10,00 p. 141 - list. ricambi

CROMATO / MAN. CROMATO o ROSSO B1

01-4705/4/BS	€ 340,00
01-476001 o B1-476001	€ 2 x 58,00

PREZZO TOTALE € 456,00**CROMATO / MANIGLIA IN ALTRA FINITURA**

01-4705/4/BS	€ 340,00
XX-476001	€ 2 x 58,00 x M*

ALTRE FINITURE

XX-4705/4/BS	€ 340,00 x M*
XX-476001	€ 2 x 58,00 x M*

4705/S + 476001

[mix]

[maniglia]

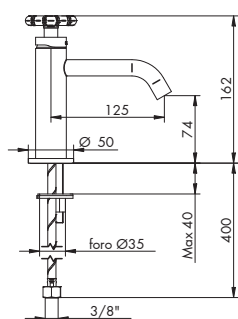

rosso B1

MISCELATORE LAVABO MONOFORO

- > cartuccia tradizionale
- > interasse bocca 125
- > limitatore di portata 5 l/min 3bar
- > flessibili di alimentazione
- > senza scarico
- > cod. B1 = rosso fabrique

	0136/U cromato € 58,00 p. 41
	455039 € 47,00 p. 150 - list. ricambi
	454038 € 10,00 p. 141 - list. ricambi

CROMATO / MAN. CROMATO o ROSSO B1

01-4705/S	€ 194,00
01-476001 o B1-476001	€ 58,00

PREZZO TOTALE € 252,00**CROMATO / MANIGLIA IN ALTRA FINITURA**

01-4705/S	€ 194,00
XX-476001	€ 58,00 x M*

ALTRE FINITURE

XX-4705/S	€ 194,00 x M*
XX-476001	€ 58,00 x M*

4705/P/S + 476001

[mix]

[maniglia]

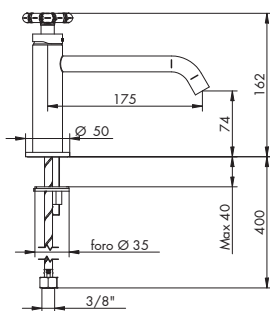

rosso B1

MISCELATORE LAVABO MONOFORO BOCCA PROLUNGATA

- > cartuccia tradizionale
- > interasse bocca 175
- > limitatore di portata 5 l/min 3bar
- > flessibili di alimentazione
- > senza scarico
- > cod. B1 = rosso fabrique

	0136/U cromato € 58,00 p. 41
	455039 € 47,00 p. 150 - list. ricambi
	454038 € 10,00 p. 141 - list. ricambi

CROMATO / MAN. CROMATO o ROSSO B1

01-4705/P/S	€ 204,00
01-476001 o B1-476001	€ 58,00

PREZZO TOTALE € 262,00**CROMATO / MANIGLIA IN ALTRA FINITURA**

01-4705/P/S	€ 204,00
XX-476001	€ 58,00 x M*

ALTRE FINITURE

XX-4705/P/S	€ 204,00 x M*
XX-476001	€ 58,00 x M*

474015 | 474016 | 474017**PROLUNGHE MISCELATORE LAVABO**

- > diametro 34 mm
- > altezza 50 mm, 100 mm, 150 mm

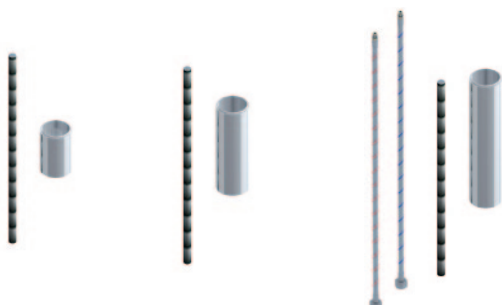
**CROMATO**

01-474015	50 mm	€ 52,00
01-474016	100 mm	€ 67,00
01-474017	150 mm	€ 111,00

ALTRE FINITURE

XX-474015	50 mm	€ 52,00 x M*
XX-474016	100 mm	€ 67,00 x M*
XX-474017	150 mm	€ 111,00 x M*



4705/1 + 476001

[mix] [maniglia]



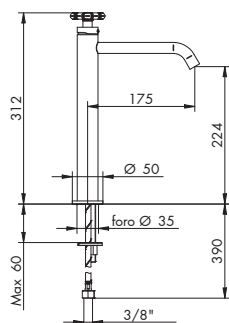

rosso B1



MISCELATORE LAVABO MONOFORO ALTO BOCCA PROLUNGATA

- > cartuccia tradizionale
- > interasse bocca 175
- > limitatore di portata 5 l/min 3bar
- > flessibili di alimentazione
- > senza scarico
- > cod. B1 = rosso fabrique

	0136/U cromato € 58,00 p. 41
	455039 € 47,00 p. 150 - list. ricambi
	454038 € 10,00 p. 141 - list. ricambi

CROMATO / MAN. CROMATO o ROSSO B1	
01-4705/1	€ 299,00
01-476001 o B1-476001	€ 58,00
PREZZO TOTALE	€ 357,00

CROMATO / MANIGLIA IN ALTRA FINITURA	
01-4705/1	€ 299,00
XX-476001	€ 58,00 x M*

ALTRE FINITURE	
XX-4705/1	€ 299,00 x M*
XX-476001	€ 58,00 x M*

4705/6/E + 476001 + 054061

[parte esterna] [maniglia] [parte incasso]



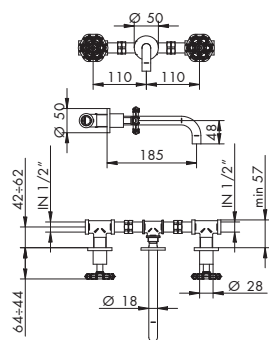

rosso B1



GRUPPO LAVABO DA PARETE

- > vitone ceramico 90°
- > interasse bocca 185
- > limitatore di portata 5 l/min 3bar
- > ingressi da 1/2"
- > senza scarico
- > cod. B1 = rosso fabrique

	0136/U cromato € 58,00 p. 41
	055001 € 20,00 p. 151 - list. ricambi
	454038 € 10,00 p. 141 - list. ricambi

P. EST. - CROMATO / MAN. CROMATO o ROSSO B1	
01-4705/6/E	€ 190,00
01-476001 o B1-476001	€ 2 x 58,00

P. EST. - CROMATO / MAN. IN ALTRA FINITURA	
01-4705/6/E	€ 190,00
XX-476001	€ 2 x 58,00 x M*

PARTE INCASSO	
054061	€ 116,00
PREZZO TOTALE	€ 422,00

PARTI ESTERNE - ALTRE FINITURE	
XX-4705/6/E	€ 190,00 x M*
XX-476001	€ 2 x 58,00 x M*

4705/6/1E + 476001 + 054061

[parte esterna] [maniglia] [parte incasso]



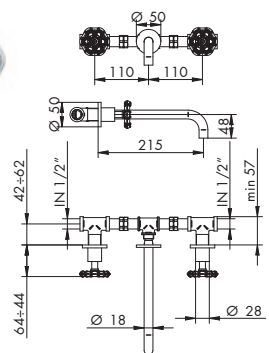

rosso B1



GRUPPO LAVABO DA PARETE BOCCA PROLUNGATA

- > vitone ceramico 90°
- > interasse bocca 215
- > limitatore di portata 5 l/min 3bar
- > ingressi da 1/2"
- > senza scarico
- > cod. B1 = rosso fabrique

	0136/U cromato € 58,00 p. 41
	055001 € 20,00 p. 151 - list. ricambi
	454038 € 10,00 p. 141 - list. ricambi

P. EST. - CROMATO / MAN. CROMATO o ROSSO B1	
01-4705/6/1E	€ 203,00
01-476001 o B1-476001	€ 2 x 58,00

P. EST. - CROMATO / MAN. IN ALTRA FINITURA	
01-4705/6/1E	€ 203,00
XX-476001	€ 2 x 58,00 x M*

PARTE INCASSO	
054061	€ 116,00
PREZZO TOTALE	€ 435,00

PARTI ESTERNE - ALTRE FINITURE	
XX-4705/6/1E	€ 203,00 x M*
XX-476001	€ 2 x 58,00 x M*

4705/3/BE + 476001 + 894001

[parte esterna] [maniglia] [parte incasso]



rosso B1

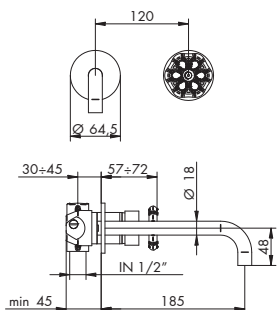

MISCELATORE LAVABO DA PARETE BOCCA PROLUNGATA

- > cartuccia tradizionale
- > interasse bocca 185
- > limitatore di portata 5 l/min 3bar
- > ingressi da 1/2"
- > senza scarico
- > rosoni separati
- > cod. B1 = rosso fabrique

	0136/U cromato € 58,00 p. 41
	025002 € 30,00 p. 149 - list. ricambi
	454038 € 10,00 p. 141 - list. ricambi

P. EST. - CROMATO / MAN. CROMATO o ROSSO B1	
01-4705/3/BE	€ 150,00
01-476001 o B1-476001	€ 58,00

P. EST. - CROMATO / MAN. IN ALTRA FINITURA	
01-4705/3/BE	€ 150,00
XX-476001	€ 58,00 x M*

PARTE INCASSO	
01-894001	€ 105,00
PREZZO TOTALE	€ 313,00

PARTI ESTERNE - ALTRE FINITURE	
XX-4705/3/BE	€ 150,00 x M*
XX-476001	€ 58,00 x M*

4705/3/CE + 476001 + 894001

[parte esterna] [maniglia] [parte incasso]

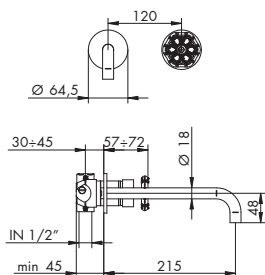

rosso B1

MISCELATORE LAVABO DA PARETE BOCCA EXTRA PROLUNGATA

- > cartuccia tradizionale
- > interasse bocca 215
- > limitatore di portata 5l/min 3bar
- > ingressi da 1/2"
- > senza scarico
- > rosoni separati
- > cod. B1 = rosso fabrique



P. EST. - CROMATO / MAN. CROMATO o ROSSO B1	
01-4705/3/CE	€ 163,00
01-476001 o B1-476001	€ 58,00
PARTE INCASSO	
01-894001	€ 105,00
PREZZO TOTALE	€ 326,00

P. EST. - CROMATO / MAN. IN ALTRA FINITURA	
01-4705/3/CE	€ 163,00
XX-476001	€ 58,00 x M*
PARTI ESTERNE - ALTRE FINITURE	
XX-4705/3/CE	€ 163,00 x M*
XX-476001	€ 58,00 x M*

4705/3/2E + 476001 + 894001

[parte esterna] [maniglia] [parte incasso]

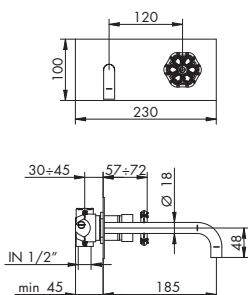

rosso B1

MISCELATORE LAVABO DA PARETE BOCCA PROLUNGATA SU PIASTRA

- > cartuccia tradizionale
- > interasse bocca 185
- > limitatore di portata 5l/min 3bar
- > ingressi da 1/2"
- > senza scarico
- > piastra unica rettangolare
- > cod. B1 = rosso fabrique



P. EST. - CROMATO / MAN. CROMATO o ROSSO B1	
01-4705/3/2E	€ 224,00
01-476001 o B1-476001	€ 58,00
PARTE INCASSO	
01-894001	€ 105,00
PREZZO TOTALE	€ 387,00

P. EST. - CROMATO / MAN. IN ALTRA FINITURA	
01-4705/3/2E	€ 224,00
XX-476001	€ 58,00 x M*
PARTI ESTERNE - ALTRE FINITURE	
XX-4705/3/2E	€ 224,00 x M*
XX-476001	€ 58,00 x M*

4705/3/3E + 476001 + 894001

[parte esterna] [maniglia] [parte incasso]

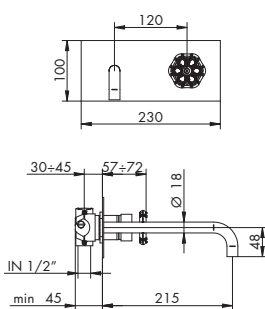

rosso B1

MISCELATORE LAVABO DA PARETE BOCCA EXTRA PROLUNGATA SU PIASTRA

- > cartuccia tradizionale
- > interasse bocca 215
- > limitatore di portata 5l/min 3bar
- > ingressi da 1/2"
- > senza scarico
- > piastra unica rettangolare
- > cod. B1 = rosso fabrique



P. EST. - CROMATO / MAN. CROMATO o ROSSO B1	
01-4705/3/3E	€ 237,00
01-476001 o B1-476001	€ 58,00
PARTE INCASSO	
01-894001	€ 105,00
PREZZO TOTALE	€ 400,00

P. EST. - CROMATO / MAN. IN ALTRA FINITURA	
01-4705/3/3E	€ 237,00
XX-476001	€ 58,00 x M*
PARTI ESTERNE - ALTRE FINITURE	
XX-4705/3/3E	€ 237,00 x M*
XX-476001	€ 58,00 x M*

4705/R/A + 476001

[mix] [maniglia]

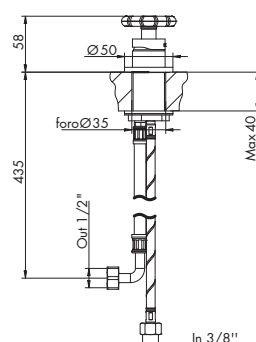

rosso B1

MISCELATORE REMOTO

- > cartuccia tradizionale
- > flessibili di alimentazione
- > senza scarico
- > cod. B1 = rosso fabrique

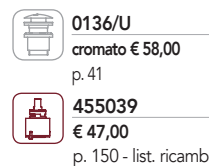

CROMATO / MAN. CROMATO o ROSSO B1	
01-4705/R/A	€ 225,00
01-476001 o B1-476001	€ 58,00
PREZZO TOTALE	€ 283,00

CROMATO / MANIGLIA IN ALTRA FINITURA	
01-4705/R/A	€ 225,00
XX-476001	€ 58,00 x M*
ALTRE FINITURE	
XX-4705/R/A	€ 225,00 x M*
XX-476001	€ 58,00 x M*

4705/R/BE + 476001 + 104033

[parte esterna] [maniglia] [parte incasso]

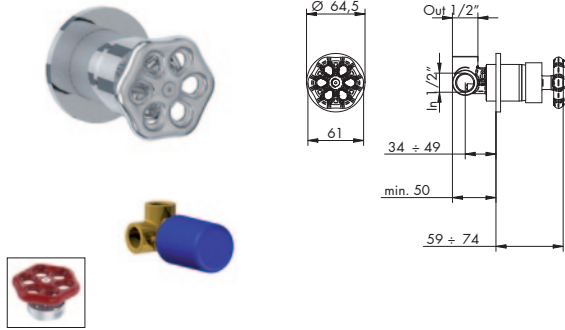

rosso B1

MISCELATORE INCASSO REMOTO

- > cartuccia tradizionale
- > ingressi da 1/2"
- > uscita superiore
- > senza scarico
- > cod. B1 = rosso fabrique

 **0136/U**
cromato € 58,00
p. 41

 **025002**
€ 30,00
p. 149 - list. ricambi

P. EST. - CROMATO / MAN. CROMATO o ROSSO B1	
01-4705/R/BE	€ 90,00
01-476001 o B1-476001	€ 58,00
PARTE INCASSO	
01-104033	€ 113,00
PREZZO TOTALE	€ 261,00

P. EST. - CROMATO / MAN. IN ALTRA FINITURA	
01-4705/R/BE	€ 90,00
XX-476001	€ 58,00 x M*

PARTI ESTERNE - ALTRE FINITURE	
XX-4705/R/BE	€ 90,00 x M*
XX-476001	€ 58,00 x M*

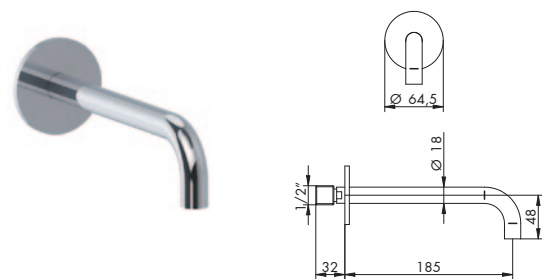
464008**BOCCA LAVABO DA PARETE**

- > interasse bocca 185
- > limitatore di portata 5 l/min 3 bar
- > attacco da 1/2"
- > rosone tondo

 **0136/U**
cromato € 58,00
p. 41

 **454038**
€ 10,00
p. 141 - list. ricambi

CROMATO	
01-464008	€ 90,00

ALTRE FINITURE	
XX-464008	€ 90,00 x M*

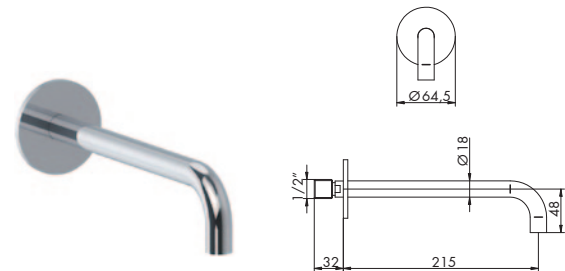
464014**BOCCA LAVABO DA PARETE**

- > interasse bocca 215
- > limitatore di portata 5 l/min 3 bar
- > attacco da 1/2"
- > rosone tondo

 **0136/U**
cromato € 58,00
p. 41

 **454038**
€ 10,00
p. 141 - list. ricambi

CROMATO	
01-464014	€ 106,00

ALTRE FINITURE	
XX-464014	€ 106,00 x M*

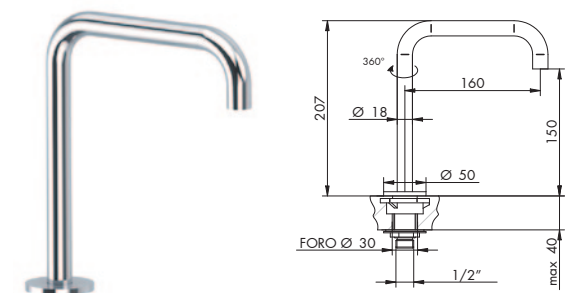
4705/1/B**BOCCA MONOFORO GIREVOLE**

- > interasse bocca 160
- > bocca girevole 360°
- > limitatore di portata 5 l/min 3bar
- > attacco da 1/2"

 **0136/U**
cromato € 58,00
p. 41

 **454038**
€ 10,00
p. 141 - list. ricambi

CROMATO	
01-4705/1/B	€ 198,00

ALTRE FINITURE	
XX-4705/1/B	€ 198,00 x M*

4707/4/S + 476001

[batteria] [maniglia]



rosso B1

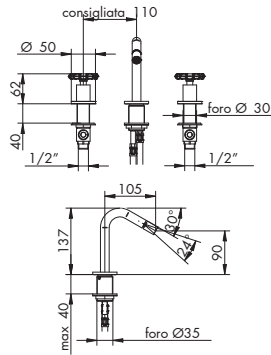

BATTERIA BIDET 3 FORI BOCCA GIREVOLE

- > vitone ceramico 90°
- > interasse bocca 105
- > bocca girevole 360°
- > limitatore di portata 5 l/min 3 Bar
- > aeratore snodato
- > senza flessibili di alimentazione
- > senza scarico
- > cod. B1 = rosso fabrique

CROMATO / MAN. CROMATO o ROSSO B1	
01-4707/4/S	€ 340,00
01-476001 o B1-476001	€ 2 x 58,00

PREZZO TOTALE € 456,00

CROMATO / MANIGLIA IN ALTRA FINITURA	
01-4707/4/S	€ 340,00
XX-476001	€ 2 x 58,00 x M*

ALTRE FINITURE	
XX-4707/4/S	€ 340,00 x M*
XX-476001	€ 2 x 58,00 x M*

- 0136/U cromato € 58,00 p. 41
- 605007 € 20,00 p. 151 - list. ricambi
- 454038 € 10,00 p. 141 - list. ricambi

4707/S + 476001

[mix] [maniglia]



rosso B1

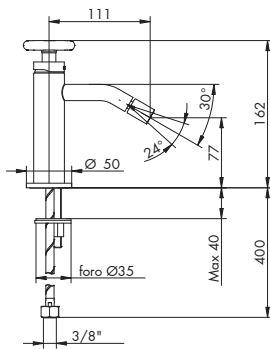

MISCELATORE BIDET MONOFORO

- > cartuccia tradizionale
- > interasse bocca 111
- > aeratore snodato
- > limitatore di portata 5 l/min 3 Bar
- > flessibili di alimentazione
- > senza scarico
- > cod. B1 = rosso fabrique

CROMATO / MAN. CROMATO o ROSSO B1	
01-4707/S	€ 194,00
01-476001 o B1-476001	€ 58,00

PREZZO TOTALE € 252,00

CROMATO / MANIGLIA IN ALTRA FINITURA	
01-4707/S	€ 194,00
XX-476001	€ 58,00 x M*

ALTRE FINITURE	
XX-4707/S	€ 194,00 x M*
XX-476001	€ 58,00 x M*

- 0136/U cromato € 58,00 p. 41
- 455039 € 47,00 p. 150 - list. ricambi
- 454038 € 10,00 p. 141 - list. ricambi

464003

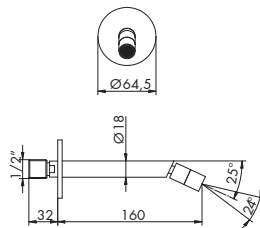

BOCCA BIDET DA PARETE

- > interasse bocca 160
- > aeratore snodato
- > attacco da 1/2"
- > rosone tondo

CROMATO	
01-464003	€ 129,00

ALTRE FINITURE	
XX-464003	€ 129,00 x M*

- 0136/U cromato € 58,00 p. 41
- 014076 cromato € 24,00 rosso B1 € 36,00 p. 140 - list. ricambi

4721/E + 476001 + 104018

[parte esterna] [maniglia] [parte incasso]



rosso B1

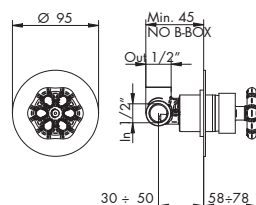

MISCELATORE INCASSO

- > cartuccia tradizionale
- > ingressi da 1/2"
- > uscita superiore
- > incasso c/b-box
- > cod. B1 = rosso fabrique

P. EST. - CROMATO / MAN. CROMATO o ROSSO B1	
01-4721/E	€ 87,00
01-476001 o B1-476001	€ 58,00

PARTE INCASSO	
01-104018	€ 113,00
PREZZO TOTALE	€ 258,00

P. EST. - CROMATO / MAN. IN ALTRA FINITURA	
01-4721/E	€ 87,00
XX-476001	€ 58,00 x M*

PARTI ESTERNE - ALTRE FINITURE	
XX-4721/E	€ 87,00 x M*
XX-476001	€ 58,00 x M*

- 025002 € 30,00 p. 149 - list. ricambi

4700/E + 476001 + 104002

[parte esterna] [maniglia] [parte incasso]

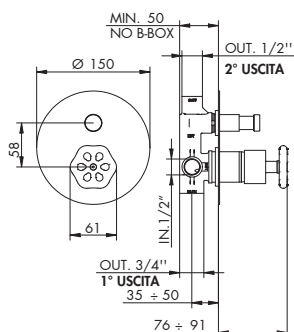
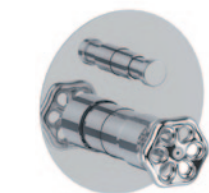

rosso B1



MISCELATORE INCASSO C/DEVIATORE 2 USCITE

- > cartuccia tradizionale
- > deviatore a pressione 2 uscite c/ritorno automatico e blocco meccanico basse pressioni
- > attacchi da 1/2"
- > uscita principale inferiore da 3/4"
- > incasso c/b-box
- > cod. B1 = rosso fabrique



025002

€ 30,00

p. 149 - list. ricambi



105029

€ 38,00

p. 131 - list. ricambi

P. EST. - CROMATO / MAN. CROMATO o ROSSO B1

01-4700/E € 103,00

01-476001 o B1-476001 € 58,00

P. EST. - CROMATO / MAN. IN ALTRA FINITURA

01-4700/E € 103,00

XX-476001 € 58,00 x M*

PARTE INCASSO

01-104002 € 231,00

PREZZO TOTALE € 392,00

PARTI ESTERNE - ALTRE FINITURE

XX-4700/E € 103,00 x M*

XX-476001 € 58,00 x M*

4703/2/1E + 476001 + 914016

[parte esterna] [maniglia] [parte incasso]

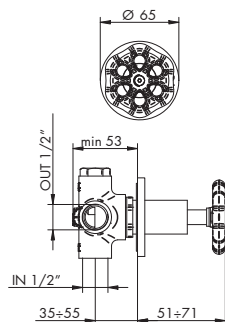
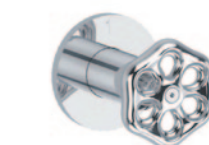

rosso B1

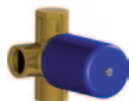

DEVIATORE INCASSO 2 USCITE

- > deviatore a dischi ceramici 2 uscite senza chiusura
- > attacchi da 1/2"
- > cod. B1 = rosso fabrique



635010

€ 49,00

p. 131 - list. ricambi

P. EST. - CROMATO / MAN. CROMATO o ROSSO B1

01-4703/2/1E € 113,00

01-476001 o B1-476001 € 58,00

P. EST. - CROMATO / MAN. IN ALTRA FINITURA

01-4703/2/1E € 113,00

XX-476001 € 58,00 x M*

PARTE INCASSO

914016 € 85,00

PREZZO TOTALE € 256,00

PARTI ESTERNE - ALTRE FINITURE

XX-4703/2/1E € 113,00 x M*

XX-476001 € 58,00 x M*

4703/3/1E + 476001 + 034127

[parte esterna] [maniglia] [parte incasso]

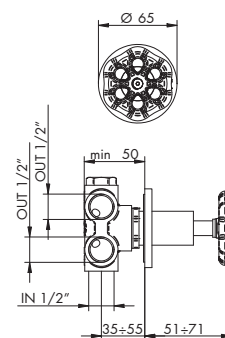
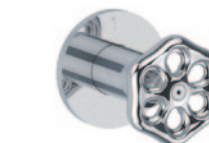

rosso B1

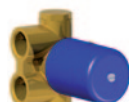

DEVIATORE INCASSO 3 USCITE

- > deviatore a dischi ceramici 3 uscite senza chiusura
- > attacchi da 1/2"
- > cod. B1 = rosso fabrique



635011

€ 49,00

p. 131 - list. ricambi

P. EST. - CROMATO / MAN. CROMATO o ROSSO B1

01-4703/3/1E € 113,00

01-476001 o B1-476001 € 58,00

P. EST. - CROMATO / MAN. IN ALTRA FINITURA

01-4703/3/1E € 113,00

XX-476001 € 58,00 x M*

PARTE INCASSO

034127 € 118,00

PREZZO TOTALE € 289,00

PARTI ESTERNE - ALTRE FINITURE

XX-4703/3/1E € 113,00 x M*

XX-476001 € 58,00 x M*

4703/4/1E + 476001 + 034128

[parte esterna] [maniglia] [parte incasso]

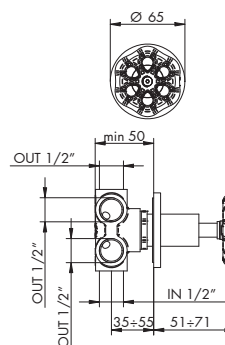

rosso B1



DEVIATORE INCASSO 4 USCITE

- > deviatore a dischi ceramici 4 uscite senza chiusura
- > attacchi da 1/2"
- > cod. B1 = rosso fabrique



635012

€ 49,00

p. 131 - list. ricambi

P. EST. - CROMATO / MAN. CROMATO o ROSSO B1

01-4703/4/1E € 113,00

01-476001 o B1-476001 € 58,00

P. EST. - CROMATO / MAN. IN ALTRA FINITURA

01-4703/4/1E € 113,00

XX-476001 € 58,00 x M*

PARTE INCASSO

034128 € 131,00

PREZZO TOTALE € 302,00

PARTI ESTERNE - ALTRE FINITURE

XX-4703/4/1E € 113,00 x M*

XX-476001 € 58,00 x M*

RICAMBI IMMEDIATI



CARTUCCIA



CARTUCCIA DEVIATRICE



DEVIATORE

XX = CODICE FINITURA RICHIESTA: per identificare codice corretto vedi pag. 26
 M* = MOLTIPLICATORE: per calcolare il prezzo delle altre finiture vedi tabella pag. 26

4712/PE + 476001 + 484020

[parte esterna] [maniglia] [parte incasso]



rosso B1

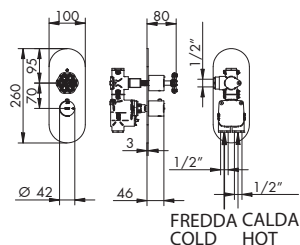

MISCELATORE TERMOSTATICO INCASSO 1 USCITA

- > cartuccia termostatica
- > vitone ceramico 90°
- > apertura con rotazione antioraria
- > interasse 70 mm
- > ingressi inferiori da 1/2"
- > incasso con B-Box
- > posizionabile orizzontalmente
- > 2 maniglie
- > cod. B1 = rosso fabrique
- > uscita laterale destra da 1/2"
- > incasso regolabile min 76
- > piastra unica

	775007 € 61,00 p. 220 - list. ricambi
	055134 € 68,00 p. 220 - list. ricambi

P. EST. - CROMATO / MAN. CROMATO o ROSSO B1	P. EST. - CROMATO / MAN. IN ALTRA FINITURA
01-4712/PE € 332,00	01-4712/PE € 332,00
01-476001 o B1-476001 € 58,00	XX-476001 € 58,00 x M*
PARTE INCASSO	PARTI ESTERNE - ALTRE FINITURE
484020 € 452,00	XX-4712/PE € 332,00 x M*
PREZZO TOTALE € 842,00	XX-476001 € 58,00 x M*

4712/2/PE + 476001 + 484021

[parte esterna] [maniglia] [parte incasso]



rosso B1

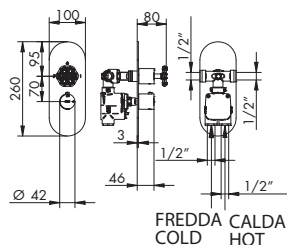

MISCELATORE TERMOSTATICO INCASSO C/DEVIATORE 2 USCITE

- > cartuccia termostatica
- > deviatore a dischi ceramici 2 uscite c/chiusura
- > interasse 70 mm
- > ingressi inferiori da 1/2"
- > incasso con B-Box
- > piastra unica
- > 2 maniglie
- > cod. B1 = rosso fabrique
- > uscite laterali da 1/2"
- > incasso regolabile min 76

	775007 € 61,00 p. 220 - list. ricambi
	035346 € 49,00 p. 212 - list. ricambi

P. EST. - CROMATO / MAN. CROMATO o ROSSO B1	P. EST. - CROMATO / MAN. IN ALTRA FINITURA
01-4712/2/PE € 332,00	01-4712/2/PE € 332,00
01-476001 o B1-476001 € 58,00	XX-476001 € 58,00 x M*
PARTE INCASSO	PARTI ESTERNE - ALTRE FINITURE
484021 € 478,00	XX-4712/2/PE € 332,00 x M*
PREZZO TOTALE € 868,00	XX-476001 € 58,00 x M*

4712/3/PE + 476001 + 484022

[parte esterna] [maniglia] [parte incasso]



rosso B1

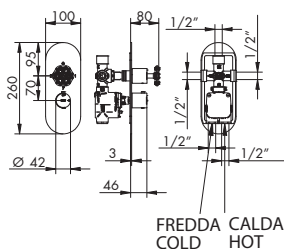

MISCELATORE TERMOSTATICO INCASSO C/DEVIATORE 3 USCITE

- > cartuccia termostatica
- > deviatore a dischi ceramici 3 uscite c/chiusura
- > interasse 70 mm
- > ingressi inferiori da 1/2"
- > uscite laterali e superiore da 1/2"
- > incasso con B-Box
- > piastra unica
- > cod. B1 = rosso fabrique
- > incasso regolabile min 76
- > 2 maniglie

	775007 € 61,00 p. 220 - list. ricambi
	035345 € 49,00 p. 212 - list. ricambi

P. EST. - CROMATO / MAN. CROMATO o ROSSO B1	P. EST. - CROMATO / MAN. IN ALTRA FINITURA
01-4712/3/PE € 332,00	01-4712/3/PE € 332,00
01-476001 o B1-476001 € 58,00	XX-476001 € 58,00 x M*
PARTE INCASSO	PARTI ESTERNE - ALTRE FINITURE
484022 € 531,00	XX-4712/3/PE € 332,00 x M*
PREZZO TOTALE € 921,00	XX-476001 € 58,00 x M*

4712/4/PE + 476001 + 484023

[parte esterna] [maniglia] [parte incasso]



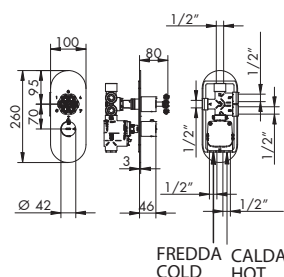

rosso B1



MISCELATORE TERMOSTATICO INCASSO C/DEVIATORE 4 USCITE

- > cartuccia termostatica
- > deviatore a dischi ceramici 4 uscite c/doppia chiusura
- > interasse 70 mm
- > ingressi inferiori da 1/2"
- > uscite laterali e superiore da 1/2"
- > incasso in ottone con B-Box
- > piastra unica
- > cod. B1 = rosso fabrique
- > incasso regolabile min 76
- > 2 maniglie

	775007 € 61,00 p. 220 - list. ricambi
	035344 € 49,00 p. 212 - list. ricambi

P. EST. - CROMATO / MAN. CROMATO o ROSSO B1	P. EST. - CROMATO / MAN. IN ALTRA FINITURA
01-4712/4/PE € 332,00	01-4712/4/PE € 332,00
01-476001 o B1-476001 € 58,00	XX-476001 € 58,00 x M*
PARTE INCASSO	PARTI ESTERNE - ALTRE FINITURE
484023 € 585,00	XX-4712/4/PE € 332,00 x M*
PREZZO TOTALE € 975,00	XX-476001 € 58,00 x M*



PER COMANDI TERMOSTATICI ALTA PORTATA, CONSULTARE LISTINO REVIVRE DA PAG. 187.

FOR HIGH FLOW RATE THERMOSTATIC MIXER, LOOK AT THE "REVIVRE" PRICE LIST FROM PAGE 187.



8812/H/P/E
+ 774035



8812/2H/P/E
+ 774036



8812/3H/P/E
+ 774033



8812/4H/P/E
+ 774034



8812/H/E
+ 884036



8812/2H/E
+ 884037



8812/3H/E
+ 884038



8812/4H/E
+ 884039

4403/1/A

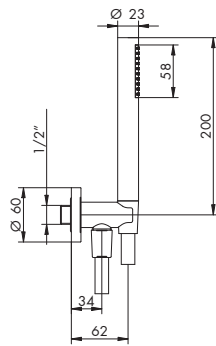

SUPPORTO DOCCIA COMPLETO

- > flessibile in PVC 150 cm
- > presa acqua con supporto fisso
- > attacchi da 1/2"
- > doccetta monogetto cilindrica in abs c/anticalcare
- > per finiture diverse da cromo doccetta in metallo

CROMATO

01-4403/1/A

€ 130,00

ALTRE FINITURE

XX-4403/1/A

€ 130,00 x M*

0530N

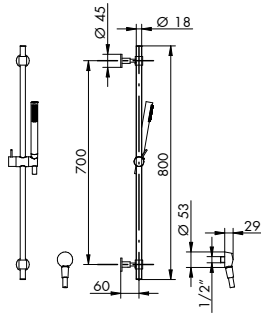

SALISCENDI COMPLETO C/PRESA D'ACQUA

- > flessibile in PVC 150 cm
- > supporto doccetta scorrevole orientabile
- > presa acqua da 1/2"
- > doccetta monogetto cilindrica in ABS c/anticalcare, per finiture diverse da cromo doccetta in metallo

CROMATO

01-0530N

€ 352,00

ALTRE FINITURE

XX-0530N

€ 352,00 x M*

0530/1N

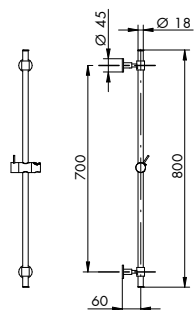

ASTA SALISCENDI

- > supporto doccetta scorrevole orientabile

CROMATO

01-0530/1N

€ 230,00

ALTRE FINITURE

XX-0530/1N

€ 230,00 x M*

PER SOLUZIONI ALTERNATIVE, CONSULTARE LISTINO REVIVRE DA PAG. 119, SEZIONE COMPLETA DOCCIA COMPLEMENTI.

FOR ALTERNATIVE SOLUTIONS, SEE THE REVIVRE PRICE LIST FROM PAGE 119, TO LOOK AT THE COMPLETE "DOCCIA COMPLEMENTI" COLLECTION.

PER COMPOSIZIONI DOCCIA CONSULTARE LISTINO REVIVRE.

FOR SHOWER TYPESETTING LOOK AT "REVIVRE" PRICE LIST.

4709/1 + 476001

[mix] [maniglia]

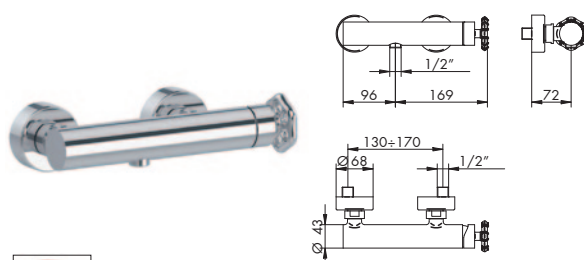

rosso B1

MISCELATORE DOCCIA ESTERNO

- > cartuccia tradizionale
- > senza set doccia
- > attacchi da 1/2"
- > cod. B1 = rosso fabrique



025002
€ 30,00
p. 149 - list. ricambi

CROMATO / MAN. CROMATO o ROSSO B1

01-4709/1	€ 333,00
01-476001 o B1-476001	€ 58,00

PREZZO TOTALE € 391,00

CROMATO / MANIGLIA IN ALTRA FINITURA

01-4709/1	€ 333,00
XX-476001	€ 58,00 x M*

ALTRE FINITURE

XX-4709/1	€ 333,00 x M*
XX-476001	€ 58,00 x M*

4701/A + 476001

[mix] [maniglia]

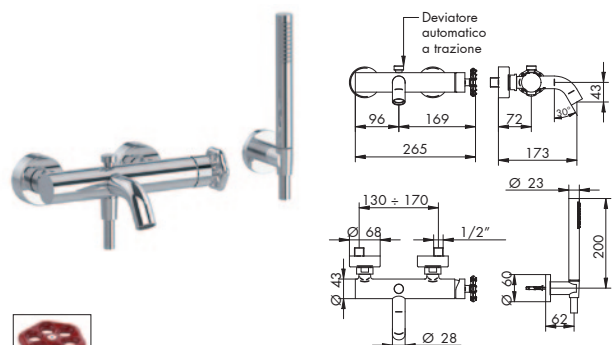

rosso B1

MISCELATORE VASCA ESTERNO

- > cartuccia tradizionale
- > interasse bocca 173
- > deviatore a trazione con ritorno automatico e blocco per basse pressioni
- > flessibile in PVC 150 cm
- > supporto a parete fisso > attacchi da 1/2"
- > doccetta monogetto cilindrica in ABS c/anticalcare
- > per finiture diverse da cromo doccetta in metallo
- > cod. B1 = rosso fabrique



025002
€ 30,00
p. 149 - list. ricambi



045057
cromato € 27,00
rosso B1 € 40,00
p. 131 - list. ricambi

CROMATO / MAN. CROMATO o ROSSO B1

01-4701/A	€ 414,00
01-476001 o B1-476001	€ 58,00

PREZZO TOTALE € 472,00

CROMATO / MANIGLIA IN ALTRA FINITURA

01-4701/A	€ 414,00
XX-476001	€ 58,00 x M*

ALTRE FINITURE

XX-4701/A	€ 414,00 x M*
XX-476001	€ 58,00 x M*

4603

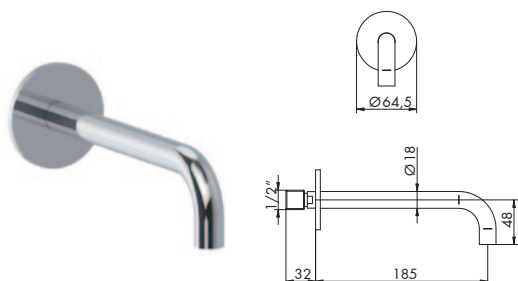

BOCCA VASCA DA PARETE

- > interasse bocca 185
- > attacchi da 1/2"



254003
€ 8,00
p. 141 - list. ricambi

CROMATO

01-4603	€ 85,00
---------	---------

ALTRE FINITURE

XX-4603	€ 85,00 x M*
---------	--------------



4708/E + 476001 + 054025

[parte esterna] [maniglia] [parte incasso]

RUBINETTO D'ARRESTO 1/2"

> vitone ceramico 90°
> ingressi da 1/2"
> cod. B1 = rosso fabrique

 055001
€ 20,00
p. 151 - list. ricambi

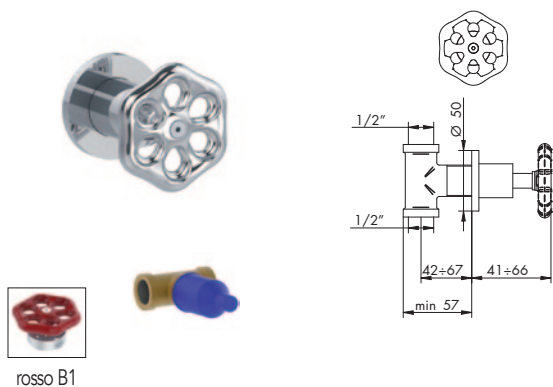

rosso B1

P. EST. - CROMATO / MAN. CROMATO o ROSSO B1	
01-4708/E	€ 60,00
01-476001 o B1-476001	€ 58,00
PARTE INCASSO	
054025	€ 45,00
PREZZO TOTALE	€ 163,00

P. EST. - CROMATO / MAN. IN ALTRA FINITURA	
01-4708/E	€ 60,00
XX-476001	€ 58,00 x M*
PARTI ESTERNE - ALTRE FINITURE	
XX-4708/E	€ 60,00 x M*
XX-476001	€ 58,00 x M*

4708/E + 476001 + 054027

[parte esterna] [maniglia] [parte incasso]

RUBINETTO D'ARRESTO 3/4"

> vitone ceramico 90°
> ingressi da 3/4"
> cod. B1 = rosso fabrique

 055001
€ 20,00
p. 151 - list. ricambi

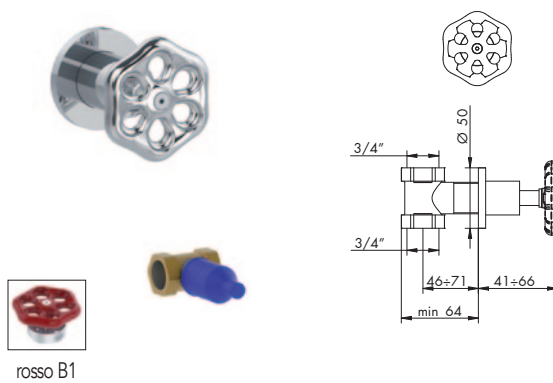

rosso B1

P. EST. - CROMATO / MAN. CROMATO o ROSSO B1	
01-4708/E	€ 60,00
01-476001 o B1-476001	€ 58,00
PARTE INCASSO	
054027	€ 67,00
PREZZO TOTALE	€ 185,00

P. EST. - CROMATO / MAN. IN ALTRA FINITURA	
01-4708/E	€ 60,00
XX-476001	€ 58,00 x M*
PARTI ESTERNE - ALTRE FINITURE	
XX-4708/E	€ 60,00 x M*
XX-476001	€ 58,00 x M*

4740/E + 476001 + 654099

[parte esterna] [maniglia] [parte incasso]

PASSO RAPIDO 3/4"

> vitone tradizionale
> abbinare a saracinesca
> ingressi da 3/4"
> cod. B1 = rosso fabrique

 654067
€ 43,00
p. 151 - list. ricambi

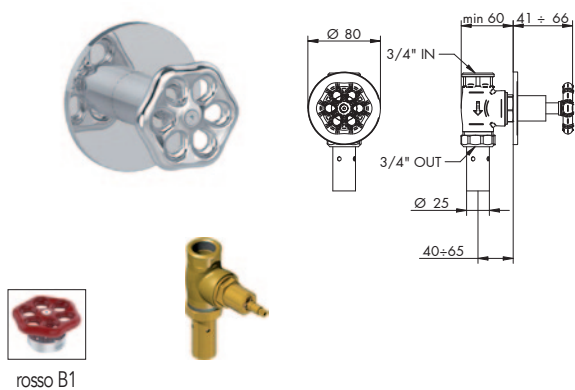

rosso B1

P. EST. - CROMATO / MAN. CROMATO o ROSSO B1	
01-4740/E	€ 85,00
01-476001 o B1-476001	€ 58,00
PARTE INCASSO	
654099	€ 114,00
PREZZO TOTALE	€ 257,00

P. EST. - CROMATO / MAN. IN ALTRA FINITURA	
01-4740/E	€ 85,00
XX-476001	€ 58,00 x M*
PARTI ESTERNE - ALTRE FINITURE	
XX-4740/E	€ 85,00 x M*
XX-476001	€ 58,00 x M*

4740/E + 476001 + 654100

[parte esterna] [maniglia] [parte incasso]

PASSO RAPIDO 1"

> vitone tradizionale
> abbinare a saracinesca
> ingressi da 1"
> cod. B1 = rosso fabrique

 654067
€ 43,00
p. 151 - list. ricambi

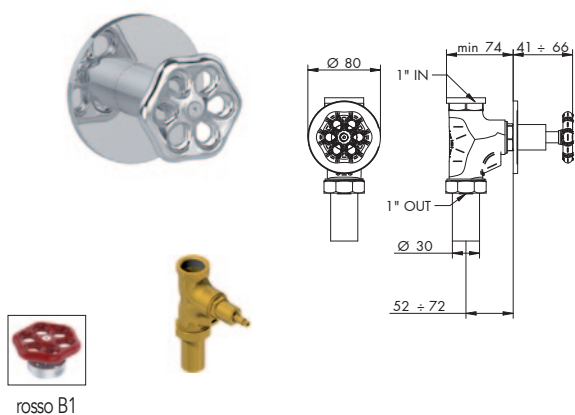

rosso B1

P. EST. - CROMATO / MAN. CROMATO o ROSSO B1	
01-4740/E	€ 85,00
01-476001 o B1-476001	€ 58,00
PARTE INCASSO	
654100	€ 114,00
PREZZO TOTALE	€ 257,00

P. EST. - CROMATO / MAN. IN ALTRA FINITURA	
01-4740/E	€ 85,00
XX-476001	€ 58,00 x M*
PARTI ESTERNE - ALTRE FINITURE	
XX-4740/E	€ 85,00 x M*
XX-476001	€ 58,00 x M*

RICAMBI IMMEDIATI



XX = CODICE FINITURA RICHIESTA: per identificare codice corretto vedi pag. 26
M* = MOLTIPLICATORE: per calcolare il prezzo delle altre finiture vedi tabella pag. 26

4732/2/E + 476001 + 035212

[parte esterna] [maniglia] [parte incasso]

SARACINESCA

> attacchi da 3/4"
> cod. B1 = rosso fabrique

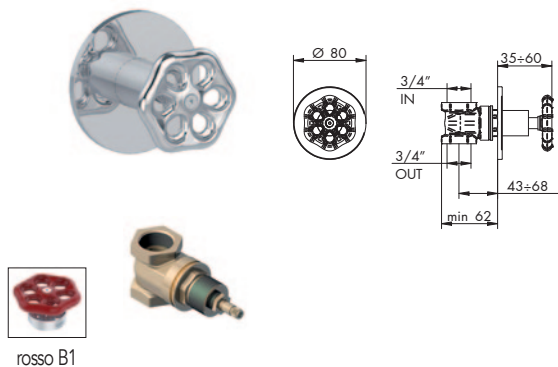

P. EST. - CROMATO / MAN. CROMATO o ROSSO B1		P. EST. - CROMATO / MAN. IN ALTRA FINITURA	
01-4732/2/E	€ 75,00	01-4732/2/E	€ 75,00
01-476001 o B1-476001	€ 58,00	XX-476001	€ 58,00 x M*
PARTE INCASSO		PARTI ESTERNE - ALTRE FINITURE	
035212	€ 48,00	XX-4732/2/E	€ 75,00 x M*
PREZZO TOTALE	€ 181,00	XX-476001	€ 58,00 x M*

0133/L

SIFONE LAVABO A BOTTIGLIA HI TECH 1"1/4

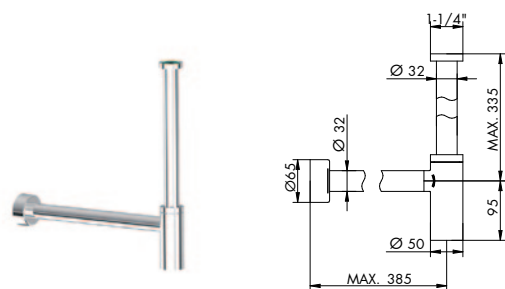

CROMATO		ALTRE FINITURE	
01-0133/L	€ 149,00	XX-0133/L	€ 149,00 x M*

0136/U

SCARICO UNIVERSALE TONDO STOP&GO 1"1/4

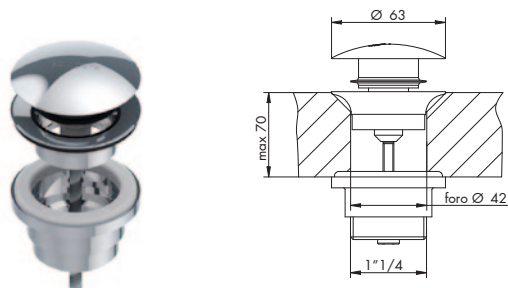

CROMATO		ALTRE FINITURE	
01-0136/U	€ 58,00	XX-0136/U	€ 58,00 x M*

020

RUBINETTO SOTTOLAVABO CON FILTRO

> attacco a parete da 1/2"
> per collegamento flessibili 3/8" o tubetti Ø10
> filtro interno per raccolta macro impurità

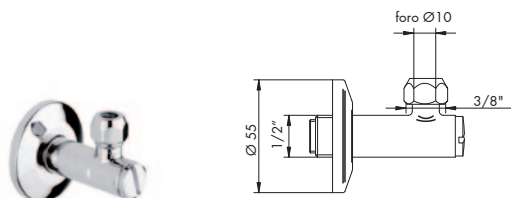

CROMATO		ALTRE FINITURE	
01-020	€ 20,00	XX-020	€ 20,00 x M*

029

TUBETTO CON CALOTTA 1/2" F

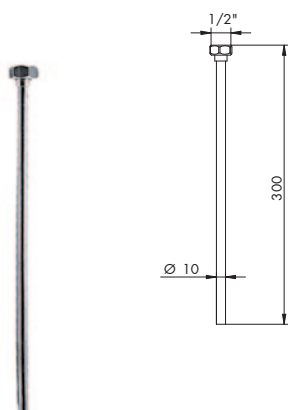

CROMATO		ALTRE FINITURE	
01-029	€ 11,00	XX-029	€ 11,00 x M*

PER SOLUZIONI ALTERNATIVE, CONSULTARE LISTINO RUBINETTERIA DA PAG. 707, SEZIONE COMPLETA ACCESSORI RUBINETTERIA.

FOR ALTERNATIVE SOLUTIONS, SEE THE "RUBINETTERIA" PRICE LIST FROM PAGE 707, TO LOOK AT THE COMPLETE "ACCESSORI RUBINETTERIA" COLLECTION.

PROGETTO SU MISURA: RICHIESTE SPECIALI

I tecnici di Bellosta Rubinetterie sono, inoltre, a disposizione di architetti e designers, per offrire un servizio esclusivo: personalizzazioni di elementi in funzione di specifiche richieste estetiche o problematiche legate a vincoli progettuali, verifica della fattibilità attraverso opportuni studi CAD e sviluppo del disegno tecnico del prodotto speciale richiesto.

Per informazioni e richieste PROGETTI SU MISURA:
ufficiotecnico@bellostarubinetterie.com

PROGETTO SU MISURA: SPECIAL REQUESTS

Engineers Bellosta Rubinetterie are also available to architects and designers, to offer an exclusive service: customizations of items according to specific aesthetic requirements or issues related to design constraints, verification of the feasibility studies and development through appropriate CAD technical design the required special product. For information and requests "SU MISURA" PROJECTS:
ufficiotecnico@bellostarubinetterie.com

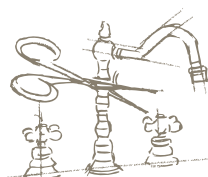

progetto
"sumisura."

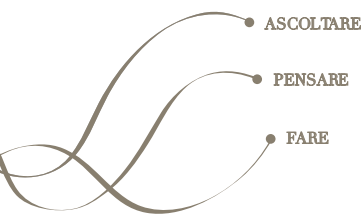

ASCOLTARE, PENSARE, FARE è la formula che abbiamo scelto per descrivere l'attenzione con cui interpretiamo i desideri del cliente, elaboriamo soluzioni ed esprimiamo proposte che ne soddisfino i gusti e le esigenze. Con lo stesso spirito, con lo stesso entusiasmo, oggi come oltre cinquantotto anni fa.

LISTEN, THINK, ACT is the philosophy that we use to describe the attention by which we interpret the wishing of the client, we find solution and make proposal for meet the taste and exigent. With the same mind and passion, today like more than fifty-eight years ago.

© 2020 Bellosta Rubinetterie. Tutti i diritti riservati.

GRAPHIC:
Roberta Teruggi

CONCEPT:
aCB

BELLOSTA CARLO & C. RUBINETTERIE Srl
Via S. Botticelli, 12/14 | 28024 Briga Novarese (No) Italia
Ingresso showroom: Largo Carlo Bellosta | Briga Novarese (No) Italia
Atelier Milano: Via Montenapoleone, 22
Atelier Roma: Piazza di Spagna, ingresso Via Gregoriana 23

T +39 0322 956 425 | 0322 912 330 | 0322 946 84
F +39 0322 955 368 | info@bellostarubinetterie.com
Export department: estero@bellostarubinetterie.com

Follow us on facebook, youTube, linked in, twitter, pinterest, instagram, houzz

Visit our website on bellostarubinetterie.com

SPECIAL THANKS TO:
Florim | www.florim.com

