

COLLEZIONI  
D' A U T O R E

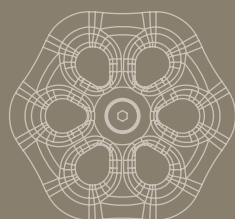

FABRIQUE  
EQB DESIGN

 **BELLOSTA**<sup>®</sup>  
rubinetterie  
rubinetti d'autore made in Italy



# index

progetto su misura	2
finiture d'autore	4
fotografico Fabrique	8
fotografico Fabrique tradizionale	18
listino prezzi	25

COLLEZIONI D'AUTORE



manifattura completamente italiana

# progetto su misura

## prodotto

Ad architetti e progettisti si vuole offrire l'opportunità di un servizio esclusivo, PROGETTO SU MISURA, personalizzando gli elementi in funzione di specifiche richieste estetiche o problematiche legate a vincoli progettuali. Oltre trenta linee, sviluppate su scala industriale si prestano ad essere modificate nelle dimensioni, nei componenti e nelle finiture per diventare la soluzione ideale in tutte le situazioni in cui è necessario uscire dagli standard.

Per informazioni e richieste PROGETTI SU MISURA: [ufficiotecnico3@bellostarubinetterie.com](mailto:ufficiotecnico3@bellostarubinetterie.com)

## product

To any architects or designers we would offer an exclusive service, the PROGETTO SU MISURA, by customizing the elements in relationship at specific aesthetic request or about projection duty. The size, components and finishings of over thirty industrial scale lines can be modified to perfectly fit all those situations that demand non-standard solutions.

For informations and PROJECTS "SU MISURA" requests:  
[ufficiotecnico3@bellostarubinetterie.com](mailto:ufficiotecnico3@bellostarubinetterie.com)

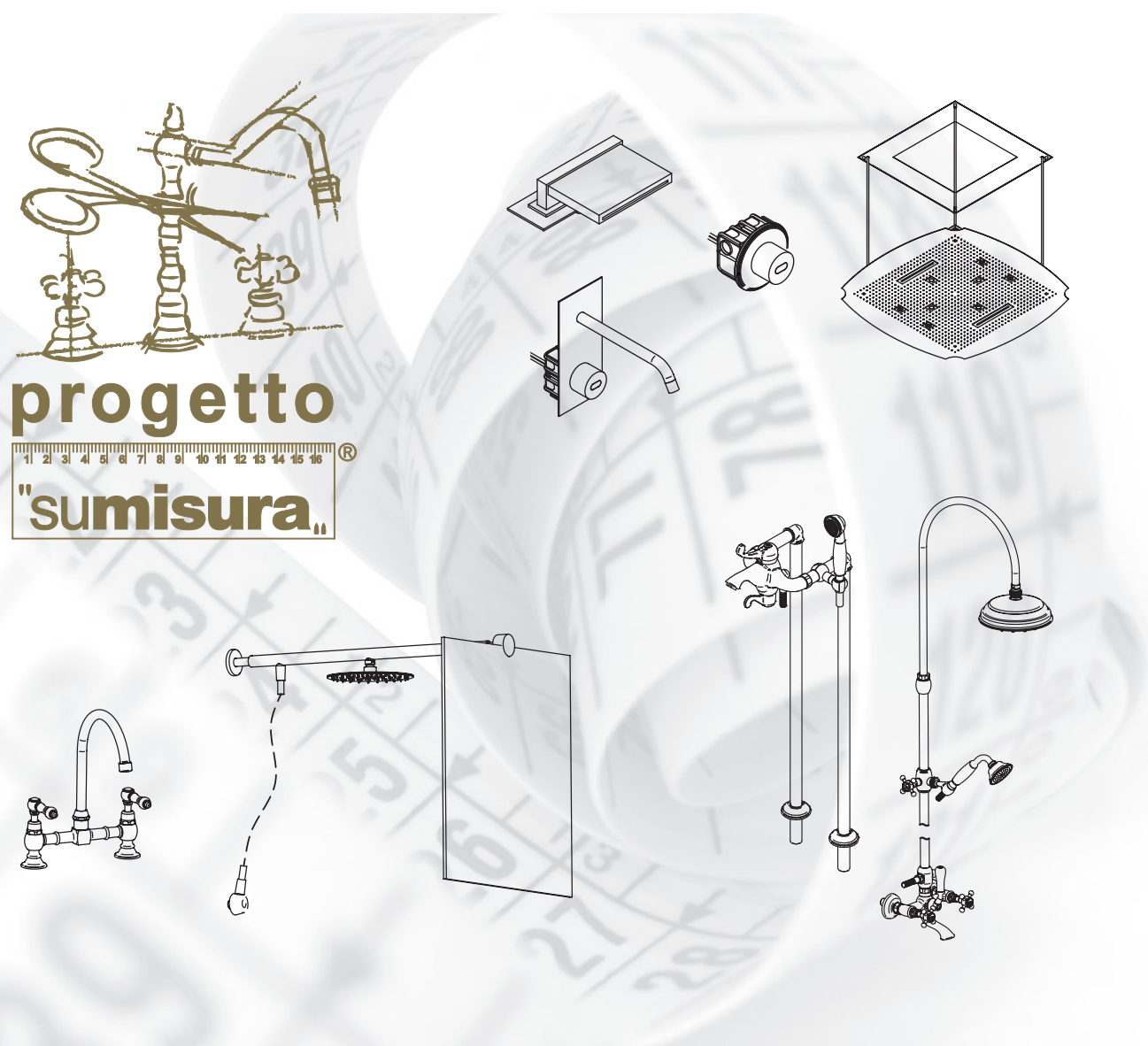

# customizing project

## colore

Il servizio PROGETTO SU MISURA non si limita alla personalizzazione a 360° delle componenti dimensionali del prodotto.

La cura del dettaglio nell'ambiente bagno è importante: la scelta della finitura a volte ricade sul cromato perchè è difficile trovare nei complementi di arredo la stessa tonalità.

Grazie a SU MISURA COLORS è possibile ottenere lo stesso colore sia sugli articoli presenti a listino sia sui componenti non prodotti da Bellosta Rubinetterie: maniglie, cerniere wc, piedini vasca, applique, profili doccia sono solo alcuni degli elementi realizzabili nella finitura scelta.

E' possibile inviare all'ufficio tecnico i complementi che si desidera ritrattare, per poterne valutare la fattibilità.

## color

The PROGETTO SU MISURA service is not limited to the 360° customization of the dimensional components of the product.

The care of detail in the bathroom environment is important: the choice of finish sometimes point on the chrome because it is difficult to find the same tonality in the furnishing complements.

Thanks to SU MISURA COLORS, it is possible to obtain the same color on both the faucet collection and the components not produced by Bellosta Rubinetterie: handles, hinges, bathtub legs, applique, shower profiles are just some of the elements that the company can turn into the finishing choice.

It is possible to send to the technical office the complements that you would like to retract, in order to evaluate the feasibility.

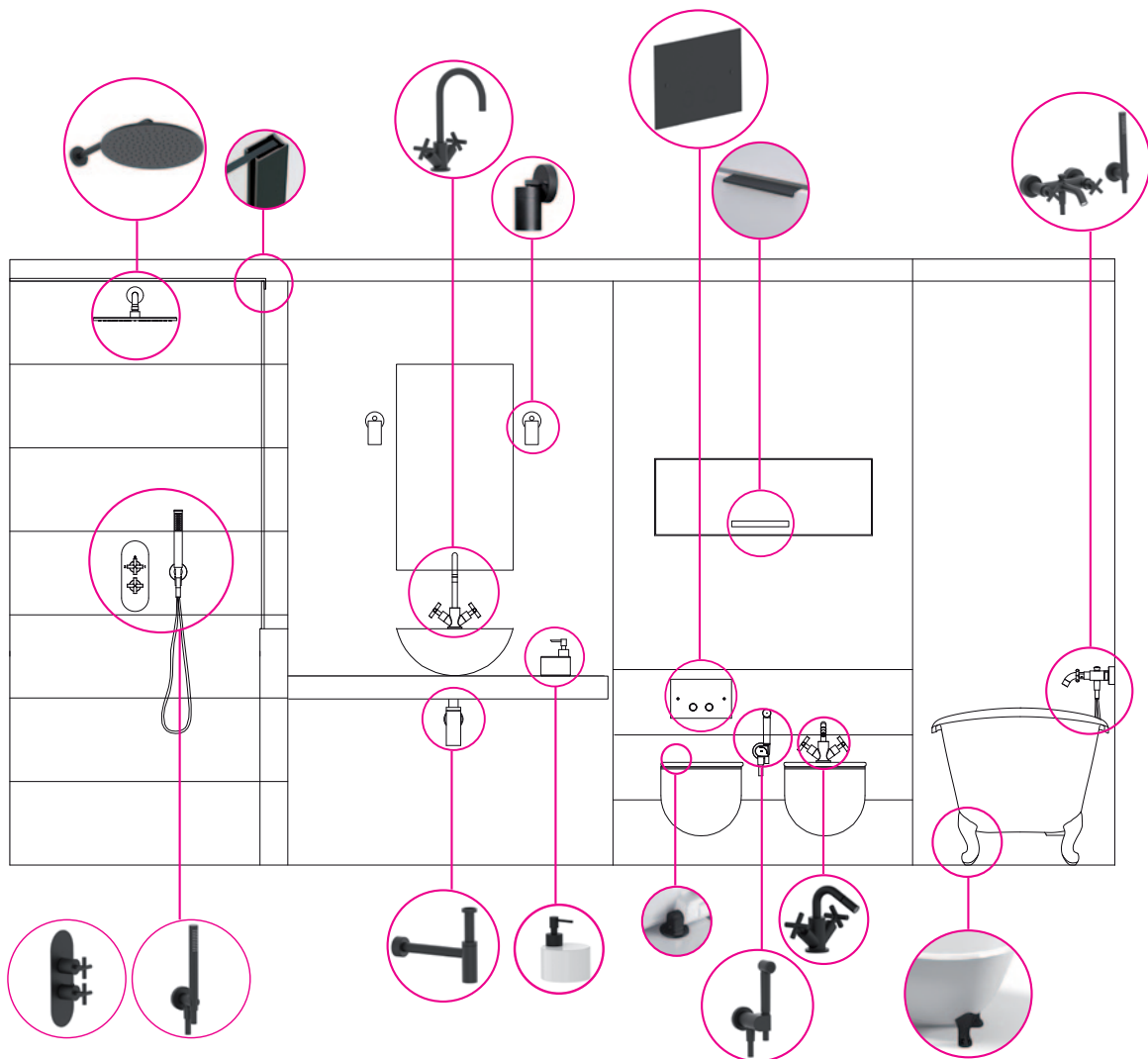

# finiture d'autore

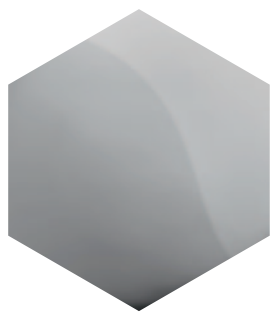

**01**

**CROMATO  
CHROME**

- > GALVANICO
- > PROTEZIONE: NO
- > INDOOR

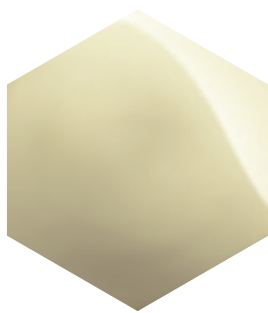

**03**

**ORO/ARGENTO  
GOLD/SILVER**

- > GALVANICO
- > PROTEZIONE: SI
- > INDOOR



**04**

**DORATO  
GOLD**

- > GALVANICO
- > PROTEZIONE: SI
- > INDOOR

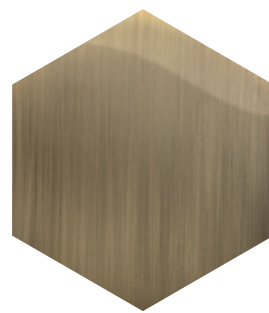

**05**

**BRONZO SATINATO  
SATIN BRONZE**

- > GALVANICO
- > SPAZZOLATURA
- > PROTEZIONE: SI
- > INDOOR

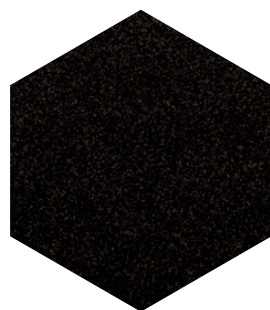

**11**

**NERO ANTRACITE  
ANTHRACITE BLACK**

- > VERNICIATURA
- > PROTEZIONE: NO
- > INDOOR

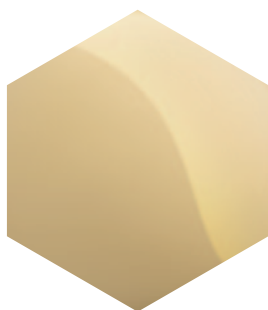

**12**

**OTTONE LUCIDO  
POLISHED BRASS**

- > SOLO LUCIDATURA
- > PROTEZIONE: SI
- > INDOOR

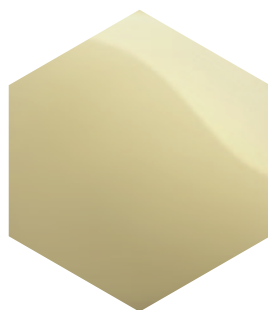

**13**

**OTTONE NATURALE\*  
NATURAL BRASS\***

- > SOLO LUCIDATURA
- > PROTEZIONE: NO
- > INDOOR / OUTDOOR



**14**

**BIANCO  
POLISHED WHITE**

- > VERNICIATURA
- > PROTEZIONE: NO
- > INDOOR

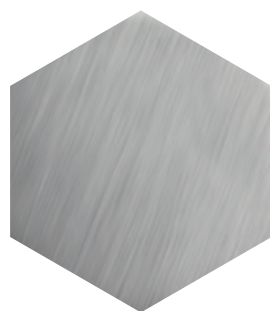

**34**

**CROMO SPAZZOLATO  
BRUSHING CHROME**

- > GALVANICO
- > SPAZZOLATURA
- > PROTEZIONE: SI
- > INDOOR

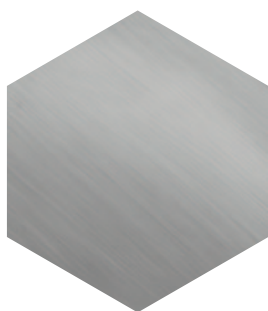

**35**

**NICKEL SPAZZOLATO  
BRUSHING NICKEL**

- > GALVANICO
- > SPAZZOLATURA
- > PROTEZIONE: SI
- > INDOOR



**56**

**AVORIO  
IVORY**

- > VERNICIATURA
- > PROTEZIONE: NO
- > INDOOR

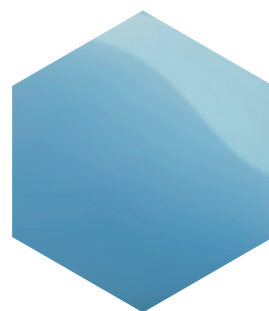

**57**

**AZZURRO  
LIGHT BLUE**

- > VERNICIATURA
- > PROTEZIONE: NO
- > INDOOR

\* ATTENZIONE! 13-OTTONE NATURALE e 88-OTTONE SISAL: finiture non protette che antichizzano naturalmente ossidando a contatto con l'umidità atmosferica.

# artist finishes



**06**

**RAME VECCHIO**  
OLD COPPER

- > GALVANICO
- > SPAZZOLATURA
- > PROTEZIONE: SI
- > INDOOR

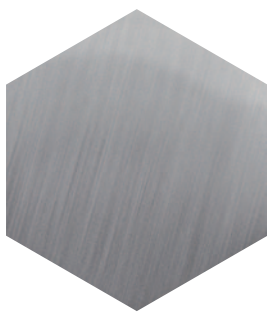

**07**

**VECCHIO ARGENTO**  
OLD SILVER

- > GALVANICO
- > SPAZZOLATURA
- > PROTEZIONE: SI
- > INDOOR

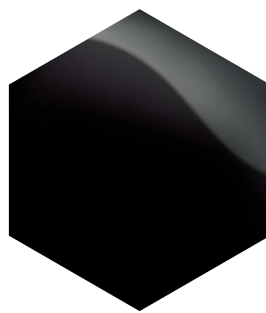

**08**

**CANNA DI FUCILE**  
GUN BARREL

- > GALVANICO
- > PROTEZIONE: SI
- > INDOOR

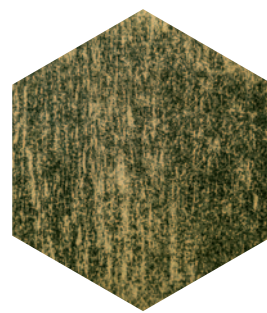

**10**

**VERDERAME**  
VERDIGRIS

- > VERNICIATURA
- > PROTEZIONE: NO
- > INDOOR

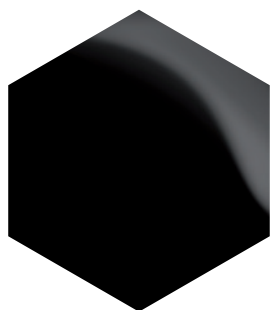

**19**

**NERO**  
POLISHED BLACK

- > VERNICIATURA
- > PROTEZIONE: NO
- > INDOOR

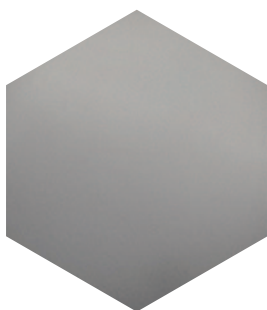

**28**

**NICKEL SATINATO**  
SATIN NICKEL

- > GALVANICO
- > PROTEZIONE: NO
- > INDOOR

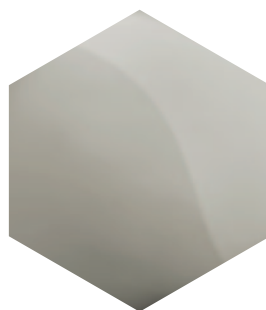

**30**

**NICKEL LUCIDO**  
POLISHED NICKEL

- > GALVANICO
- > PROTEZIONE: SI
- > INDOOR

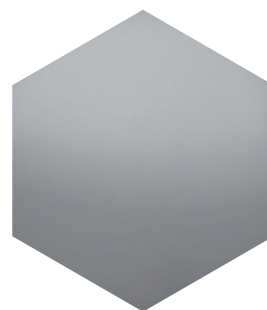

**33**

**CROMO SATINATO**  
SATIN CHROME

- > GALVANICO
- > PROTEZIONE: NO
- > INDOOR



**58**

**VERDINO**  
LIGHT GREEN

- > VERNICIATURA
- > PROTEZIONE: NO
- > INDOOR

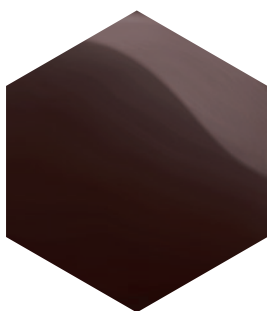

**59**

**MARRONE**  
BROWN

- > VERNICIATURA
- > PROTEZIONE: NO
- > INDOOR



**60**

**ARANCIO**  
ORANGE

- > VERNICIATURA
- > PROTEZIONE: NO
- > INDOOR

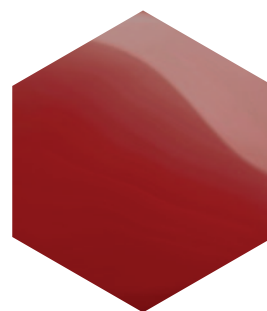

**61**

**ROSSO**  
RED

- > VERNICIATURA
- > PROTEZIONE: NO
- > INDOOR

\* WARNING! 13-NATURAL BRASS and 88-SISAL BRASS: unprotected finishes that naturally oxidise in contact with atmospheric humidity.

# finiture d'autore



**66**

**BIANCO OPACO  
MATT WHITE**

- > VERNICIATURA
- > PROTEZIONE: NO
- > INDOOR

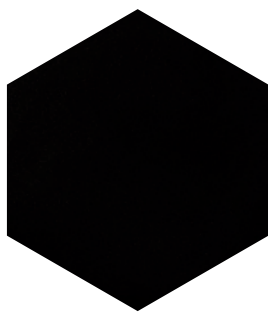

**67**

**NERO OPACO  
MATT BLACK**

- > VERNICIATURA
- > PROTEZIONE: NO
- > INDOOR

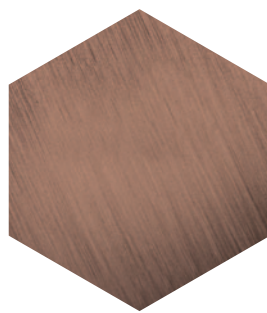

**68**

**RAME OPACO  
MATT COPPER**

- > GALVANICO
- > SPAZZOLATURA
- > PROTEZIONE: SI OPACA
- > INDOOR

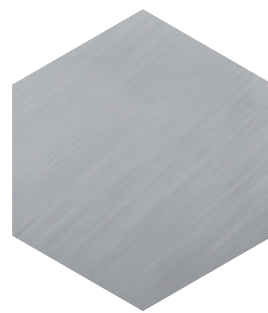

**69**

**ARGENTO OPACO  
MATT SILVER**

- > GALVANICO
- > SPAZZOLATURA
- > PROTEZIONE: SI OPACA
- > INDOOR

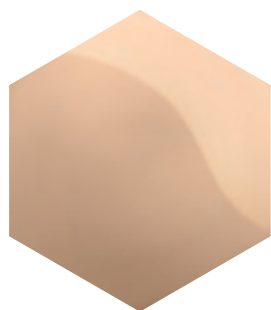

**87**

**ORO ROSA  
PINK GOLD**

- > GALVANICO
- > PROTEZIONE: NO
- > INDOOR



**88**

**OTTONE SISAL\*  
SISAL BRASS\***

- > SOLO LUCIDATURA
- > SPAZZOLATURA SISAL
- > PROTEZIONE: NO
- > INDOOR / OUTDOOR

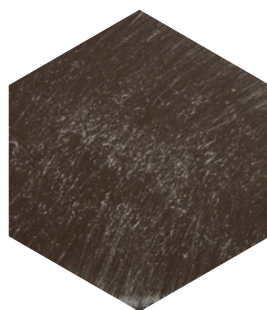

**89**

**INDUSTRIAL  
INDUSTRIAL**

- > VERNICIATURA
- > PENNELLATURA
- > PROTEZIONE : SI OPACA
- > INDOOR



**92**

**POMICE OPACO  
MATT PUMICE**

- > VERNICIATURA
- > PROTEZIONE :NO
- > INDOOR

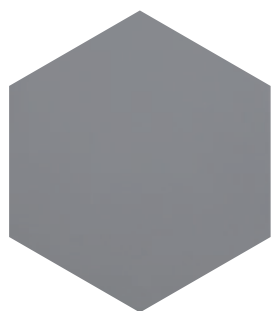

**A1**

**BRINA OPACO  
MATT FROST**

- > VERNICIATURA
- > PROTEZIONE :NO
- > INDOOR

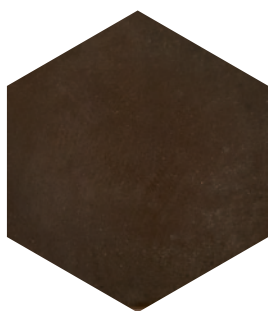

**A2**

**TUSCANY CERATO  
OILSKIN TUSCANY**

- > GALVANICO
- > SPAZZOLATURA
- > CERATURA

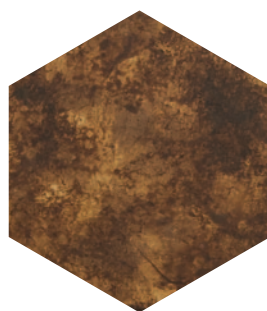

**A3**

**OTTONE ACIDATO  
ETCHED BRASS**

- > GALVANICO
- > SPAZZOLATURA
- > PROTEZIONE : SI OPACA



**A4**

**BASALTO OPACO  
MATT BASALT**

- > VERNICIATURA
- > PROTEZIONE :NO
- > INDOOR



# artist finishes

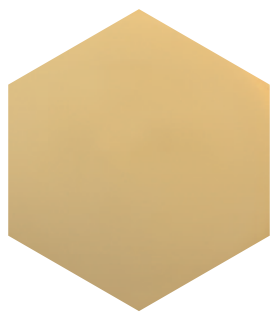

**71**

**ORO OPACO**  
**MATT GOLD**

- > GALVANICO
- > PROTEZIONE: SI OPACA
- > INDOOR

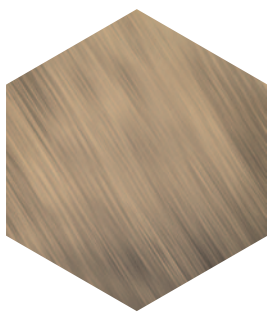

**72**

**BRONZO OPACO**  
**MATT BRONZE**

- > GALVANICO
- > SPAZZOLATURA
- > PROTEZIONE: SI OPACA
- > INDOOR



**75**

**DORATO SPAZZOLATO**  
**BRUSHING GOLD**

- > GALVANICO
- > SPAZZOLATURA
- > PROTEZIONE: SI
- > INDOOR

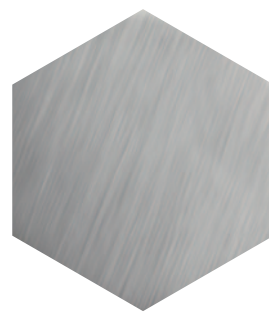

**77**

**INOX AISI 316L SPAZZOLATO**  
**BRUSHING STAINLESS AISI 316L**

- > SPAZZOLATURA
- > PROTEZIONE: NO
- > INDOOR / OUTDOOR



**93**

**ARENARIA OPACO**  
**MATT SANDSTONE**

- > VERNICIATURA
- > PROTEZIONE :NO
- > INDOOR



**94**

**TUSCANY SPAZZOLATO**  
**BRUSHING TUSCANY**

- > GALVANICO
- > SPAZZOLATURA
- > PROTEZIONE : SI OPACA

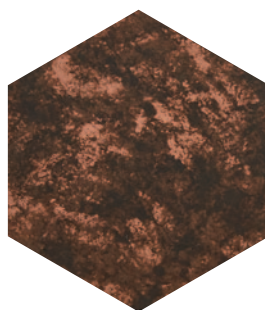

**95**

**RAME ACIDATO**  
**ETCHED COPPER**

- > GALVANICO
- > SPAZZOLATURA
- > PROTEZIONE : SI OPACA

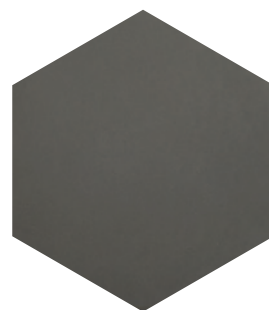

**96**

**CEMENTO OPACO**  
**MATT CEMENT**

- > VERNICIATURA
- > PROTEZIONE :NO
- > INDOOR

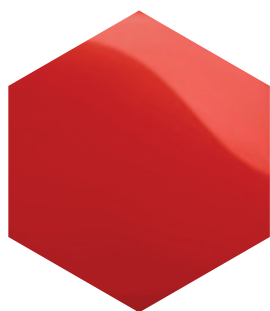

**B1**

**ROSSO FABRIQUE**  
**FABRIQUE RED**

- > VERNICIATURA
- > PROTEZIONE: NO
- > INDOOR

## English translations

galvanico: galvanic  
spazzolatura: brushing  
protezione si opaca: protector yes opaque  
protezione no: no protector

verniciatura: lacquering  
solo lucidatura: only polishing  
pennellatura: brushstrokes  
protezione si: yes protector

*Bellosta*

FINITURE D'AUTORE

Le finiture d'autore Bellosta Rubinetterie sono il risultato dell'artigianalità della produzione italiana della nostra azienda: eventuali differenze di tonalità non sono da considerarsi difetto, ma caratteristica di unicità del prodotto. Si ricorda che la Garanzia sulle finiture DECADE nel momento in cui manutenzione e pulizia NON vengano effettuate in modo adeguato e continuativo.

Bellosta Rubinetterie color finishes are the resulted of an handcrafted italian production of our firm: any eventual difference of shade, are not to consider like a defect, but like a unique featuring of the product. Please note that the Warranty on finishes DECAY when maintenance and cleaning NOT be made adequately and continuously.



# FABRIQUE

DESIGN EQB



89-4705/S + 89-476001 industrial  
industrial

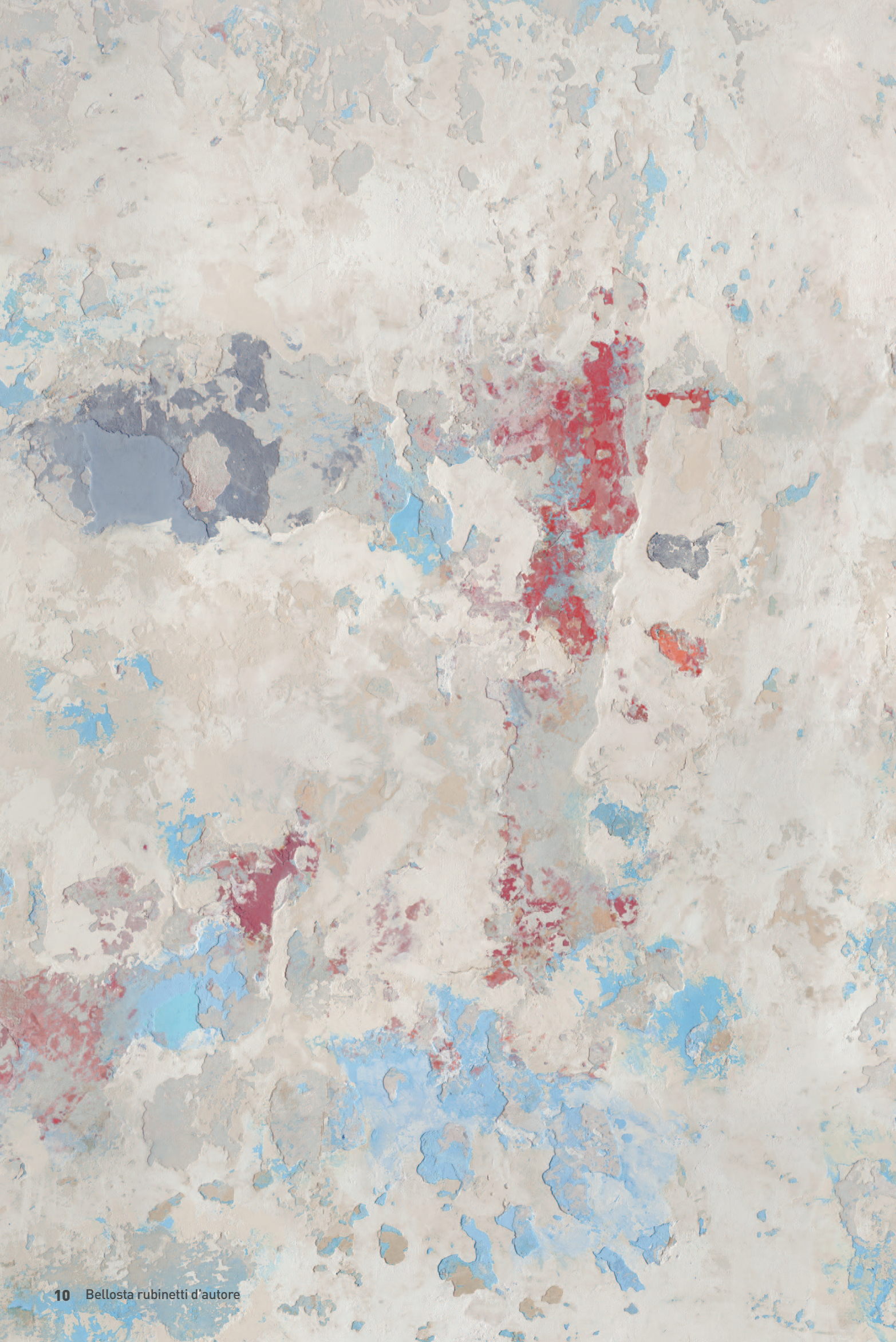



01-4705/1 + B1-476001



01-4705/1/B, 01-4705/R/A + B1-476001



01-4705/3/BE + B1-476001 + 01-894001



01-4705/S + B1-476001



**01-4705/R/BE + B1-476001 +  
01-104033**



**01-4705/R/A + B1-476001**

**01-894019**  
ref. Listino RUBINETTERIA  
STILLE



01-464003, 01-4705/R/BE + B1-476001 + 01-104033



01-4707/S + B1-476001



01-4701/A + B1-476001



01-4712/2/PE + B1-476001 + 484021  
01-4403/1/A





**01-4700/E + B1-476001 + 01-104002**

**01-884055**  
ref. Listino REVIVRE BRACCI

**01-045174**  
ref. Listino REVIVRE SOFFIONE  
STANDARD  
**01-4403/1/A**



01-4705/S + 01-476001



A1-4705/S + B1-476001



94-4705/S + 94-476001



01-4705/3/BE + 01-476001 + 01-894001



67-4705/3/BE + 67-476001 + 01-894001



72-4705/1 + 72-476001



87-4705/S + 87-476001



68-4707/S + 68-476001



# FABRIQUE

tradizionale

DESIGN EQB



01-4705/4/BS + B1-476001 cromato / rosso "fabrique"  
chrome / "fabrique" red





75-4705/4/BS + 67-476001



01-4705/4/BS + 01-476001



04-4707/4/S + 04-476001



01-4705/6/E + 92-476001 + 054061



01-4707/4/S + 19-476001





01-4712/PE + B1-476001 +  
484020



01-4721/E + B1-476001 +  
01-104018

01-0530N





# listino prezzi fabrique



tabella prezzi finiture	pag. 26
info tecniche	pag. 26
indice / index	pag. 28
lavabo	pag. 32
bidet	pag. 36
doccia incasso	pag. 36
deviatori incasso	pag. 37
doccia incasso termostatico	pag. 38
doccia complementi	pag. 39
doccia esterno	pag. 40
vasca	pag. 40
bagno complementi	pag. 41
accessori rubinetteria	pag. 42

**PREZZO FINITURE**

Calcola il prezzo di listino (IVA esclusa) delle finiture diverse dal cromato, consultando la seguente tabella.

Moltiplicare il **PREZZO LISTINO** per il **COEFFICIENTE MOLTIPLICATORE** della finitura scelta, arrotondando per difetto il prezzo ottenuto (eliminare i centesimi).  
**ESEMPIO** per ordinare art. 4705/S in finitura dorato con maniglia nero opaco: codice **04-4705/S + 67-476001**

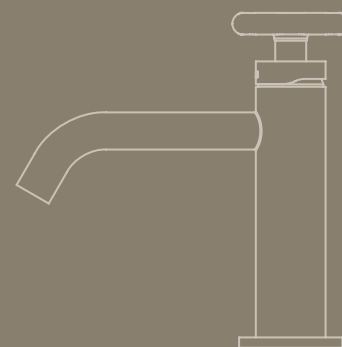
€ 194,00 (PREZZO LISTINO MIX) x 2,15 (MOLTIPLICATORE) = € ~~417,10~~ 417,00  
 € 58,00 (PREZZO LISTINO MANIGLIA) x 1,45 (MOLTIPLICATORE) = € ~~84,10~~ 84,00  
 € 417,00 + € 84,00 = € 501,00 **PREZZO TOTALE**

**PRICE FINISHES**

Include the list price (excluding VAT) of different finishes from chrome, consulting the following table. Multiply the **PRICE LIST MULTIPLIER COEFFICIENT** of the chosen finish, reducing the price obtained by deleting the centesim. **EXAMPLE** to order art. 4705/S gold finish with matt black handle: code **04-4705/S + 67-476001**

€ 194,00 (MIX PRICE LIST) x 2,15 (MULTIPLIER) = € ~~417,10~~ 417,00  
 € 58,00 (HANDLE PRICE LIST) x 1,45 (MULTIPLIER) = € ~~84,10~~ 84,00  
 € 417,00 + € 84,00 = € 501,00 **TOTAL PRICE**

**COMPOSIZIONE CODICE PER ORDINARE ARTICOLO IN FINITURA**

**XX** - **4705/S**

CODICE FINITURA FINISH CODE      CODICE ARTICOLO ITEM NUMBER      +

**XX** - **476001**

CODICE FINITURA FINISH CODE      CODICE MANIGLIA HANDLE NUMBER

**FINITURE DI SERIE / STANDARD FINISHES**

COD. CODE	DESCRIZIONE FINITURA FINISH DESCRIPTION	MOLTIPLICATORE MULTIPLIER
01-	cromato / chrome	PREZZO LISTINO°

**FINITURE A RICHIESTA / ON REQUEST FINISHES**

COD. CODE	DESCRIZIONE FINITURA FINISH DESCRIPTION	1° GRUPPO	2° GRUPPO	3° GRUPPO
02-	cromo/oro / chrome/gold	x 1,50	x 1,50	x 1,50
03-	oro/argento / gold/silver	x 1,65	x 1,75	x 1,75
04-	dorato / gold	x 2,15	x 2,20	x 2,25
05-	bronzo satinato / satin bronze	x 1,65	x 1,75	x 1,70
06-	rame vecchio / old copper	x 1,65	x 1,75	x 1,70
07-	vecchio argento / old silver	x 1,65	x 1,75	x 1,70
08-	canna di fucile / gun barrel	x 2,15	x 2,20	x 2,25
10-	verderame / verdigris	x 2,15	x 2,20	x 2,30
11-	nero antracite / anthracite black	x 2,15	x 2,20	x 2,25
12-	ottone lucido / polished brass	x 1,50	x 1,50	x 1,45
13-	ottone naturale / natural brass	x 1,30	x 1,30	x 1,20
14-	bianco / white	x 1,45	x 1,45	x 1,40
19-	nero / black	x 1,45	x 1,45	x 1,45
28-	nickel satinato / satin nickel	x 1,65	x 1,75	x 1,75
30-	nickel lucido / polished nickel	x 1,65	x 1,75	x 1,75
33-	cromo satinato / satin chrome	x 1,65	x 1,75	x 1,70
34-	cromo spazzolato / brushing chrome	x 1,70	x 1,80	x 1,80
35-	nickel spazzolato / brushing nickel	x 1,65	x 1,75	x 1,70
56-	avorio / ivory	x 1,65	x 1,75	x 1,75
57-	azzurro / light blue	x 1,65	x 1,75	x 1,75

**FINITURE A RICHIESTA / ON REQUEST FINISHES**

COD. CODE	DESCRIZIONE FINITURA FINISH DESCRIPTION	1° GRUPPO	2° GRUPPO	3° GRUPPO
58-	verdino / light green	x 1,65	x 1,75	x 1,75
59-	marrone / brown	x 1,65	x 1,75	x 1,75
60-	arancio / orange	x 1,65	x 1,75	x 1,75
61-	rosso / red	x 1,65	x 1,75	x 1,75
66-	bianco opaco / mat white	x 1,45	x 1,45	x 1,40
67-	nero opaco / matt black	x 1,45	x 1,45	x 1,40
68-	rame opaco / matt copper	x 1,65	x 1,75	x 1,75
69-	argento opaco / matt silver	x 1,65	x 1,75	x 1,70
71-	oro opaco / matt gold	x 2,15	x 2,20	x 2,25
72-	bronzo opaco / matt bronze	x 1,65	x 1,75	x 1,75
75-	dorato spazzolato / brushing gold	x 2,30	x 2,40	x 2,40
87-	oro rosa / pink gold	x 2,30	x 2,40	x 2,45
88-	ottone sisal / sisal brass	x 1,50	x 1,50	x 1,50
89-	industrial	x 2,15	x 2,20	x 2,30
92-	pomice opaco / matt pumice	x 1,85	x 1,90	x 1,90
93-	arenaria opaco / matt sandstone	x 1,85	x 1,90	x 1,90
94-	tuscany spazzolato / brushing tuscany	x 1,85	x 1,90	x 1,90
95-	rame acidato / etched copper	x 2,15	x 2,20	x 2,30
96-	cemento opaco / matt cement	x 1,85	x 1,90	x 1,90
A1-	brina opaco / matt frost	x 1,85	x 1,90	x 1,90
A2-	tuscany cerato / oilskin tuscany	x 1,85	x 1,90	x 1,90
A3-	ottone acidato / etched brass	x 2,15	x 2,20	x 2,30
A4-	basalto opaco / matt basalt	x 1,85	x 1,90	x 1,90
B1-	rosso "fabrique" / "fabrique" red	x 1,45	x 1,45	x 1,45

°PREZZO DI LISTINO / PRICE LIST

**ATTENZIONE! 13-OTTONE NATURALE e 88-OTTONE SISAL:** finiture non protette che antichizzano naturalmente ossidando a contatto con l'umidità atmosferica.  
**WARNING! 13-NATURAL BRASS and 88-SISAL BRASS:** unprotected finishes that naturally oxidise in contact with atmospheric humidity.

(!) PER LE FINITURE E I RELATIVI MOLTIPLICATORI DEI CODICI RICAMBI CONSULTARE IL LISTINO RICAMBI O CONTATTARE IL REFERENTE COMMERCIALE.  
 (!) FOR THE FINISHES AND RELATIVE MULTIPLIERS OF SPARE PARTS CODES, CONSULT THE SPARE PARTS PRICE LIST OR CONTACT THE SALE REFERENT.

ELENCO ARTICOLI SUDDIVISI PER CATEGORIA MOLTIPLICATORI FINITURE:

1° GRUPPO

- 4705/S
- 4705/P/S
- 444014
- 444015
- 444016
- 4705/1
- 4705/4/BS
- 4705/3/BE
- 4705/3/CE
- 4705/3/2E
- 4705/3/3E
- 4705/6/E
- 4705/6/1E
- 4705/R/A
- 4705/R/BE
- 464008
- 464014
- 4705/1/B

- 4707/S
- 4707/4/S
- 464003
- 4721/E
- 4700/E
- 4703/2/1E
- 4703/3/1E
- 4703/4/1E
- 4712/P/E
- 4712/2/PE
- 4712/3/PE
- 4712/4/PE
- 4709/1
- 4701/A
- 4603
- 4708/E
- 4740/E
- 4732/2/E

2° GRUPPO

- 4403/1/A
- 0530N
- 0530/1N

3° GRUPPO

- 0133/L
- 0136/U
- 020
- 029

RISPARMIO IDRICO

Per il risparmio idrico, tutte le bocche lavabo e bidet hanno aeratori con portata del flusso a 5 lt/min, sostituibili con aeratori di portata superiore qualora la bocca di erogazione venga utilizzata per il riempimento vasca.

SAVING WATER

For the saving water, all the basin and bidet spout have aerator with flow rate at 5lt/ min, interchangeable with more flow rate aerator, in the case of using spout for fill up the bath.

CONSIGLIO TECNICO

Tutti i miscelatori della collezione FABRIQUE vengono collaudati nel loro funzionamento al momento dell'assemblaggio. Per garantire la durata delle cartucce nel tempo, si consiglia di spurgare bene l'impianto idraulico prima del montaggio (per rimuovere eventuali detriti) e di installare rubinetti sottolavabo con filtro (art. 020)

N.B.: Qualora il piano lavabo avesse uno spessore superiore a 4 cm specificare la misura al momento dell'ordine.

TECHNICAL ADVICE

All mixers of the FABRIQUE collection are perfectly tested. To guarantee the perfect functionality of the cartridge for a long time, we advise to clean the sanitary plant before installing the mixer. Moreover we advise to install angle valve with filter (art. 020).

Attention: If the lavatory top is more than cm 4 thick, please point it out when placing the order.

FORATURA DEI PIANI SANITARI

I miscelatori lavabo/bidet monoforo prevedono un foro di diametro 35 mm nel piano sanitario. Le batterie lavabo 3 fori sono dotate di vitone ceramico destro con apertura a 1/4 di giro (90°); l'interasse consigliato è di 110 mm e foratura come da schema.

DRILLING PLANS HEALTH

The sink / hole bidet mixers provide a hole diameter of 35 mm in the health plan. The sink batteries 3 holes are equipped with ceramic cartridge Right-open 1/4 turn (90°); the recommended distance is 110 mm, drilling as per the diagram.

MONOFORO >>  
ONE HOLE >>

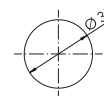

3 FORI >>  
3 HOLES >>

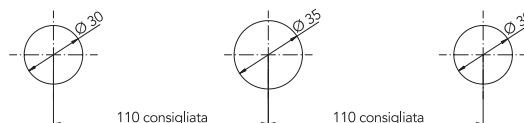

SCHEMA DI FUNZIONAMENTO MANIGLIA MISCELATORE DA PIANO E INCASSO  
SCHEME ABOUT WORKING WAY HANDLE FOR STANDING AND BUILT-IN MIXER

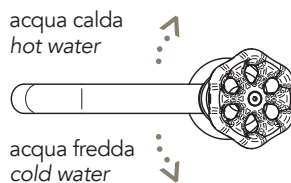
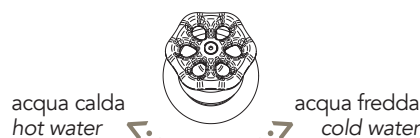
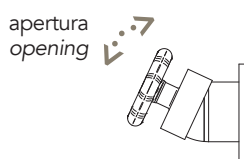
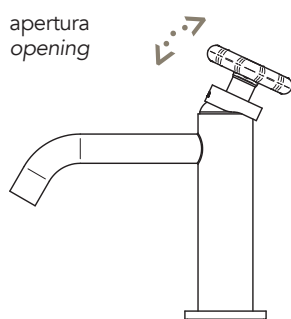

**SCHEMA FUNZIONAMENTO DEVIATORI INCASSO 2/3/4 USCITE**

Questi deviatori non hanno funzione di chiusura. Ruotando verso destra o sinistra si attivano le uscite. Tra 2 uscite adiacenti durante la rotazione diminuisce la portata dell'uscita iniziale ed incrementa quella della successiva. In posizione intermedia sono entrambe attive a pari portata.

**SCHEME OPERATION SWITCHES FLUSH OUTPUT 2/3/4**

These diverters have not closing function. By turning to the right or left activates the outputs. Between two adjacent outputs during the rotation decreases the initial output flow and increases that of the next. In position intermediate are both active at the same flow rate.

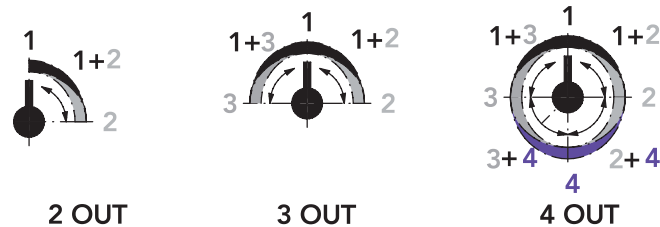

Le finiture d'autore Bellosta sono il risultato dell'artigianalità della produzione italiana della nostra azienda: eventuali differenze di tonalità non sono da considerarsi difetto, ma caratteristica di unicità del prodotto.

Bellosta color finishes are the resulted of an handcrafted italian production of our firm: any eventual difference of shade, are not to consider like a defect, but like a unique featuring of the product.

**GARANZIA FINITURE**

Si ricorda che la Garanzia sulle finiture DECADE nel momento in cui manutenzione e pulizia NON vengano effettuate in modo adeguato e continuativo.

**FINISHINGS WARRANTY**

Please note that the Warranty on finishes DECAY when maintenance and cleaning NOT be made adequately and continuously.

**MANUTENZIONE E PULIZIA**

Asciugare sempre con un panno morbido immediatamente dopo l'uso. Non utilizzare mai detersivi, agenti chimici, spugne abrasive, pagliette metalliche, alcool, che danneggerebbero irrimediabilmente le superfici del prodotto. Pulire esclusivamente con sapone neutro, abbondante acqua asciugare con panno morbido.

**MANTENAINCE AND CLEANING**

Always dry with a soft cloth immediately after use. Never use detergents, chemicals, abrasive sponges, scouring pads, alcohol, which could cause irreparable damage to the product surfaces. Clean only with natural/fresh soap, plenty of water and dry with a soft cloth.

**LEGENDA SIMBOLI**

**ACCESSORI  
ACCESSORIES**



SCARICO C/TAPPO A PRESSIONE

WASTE WITH PRESSURE CAP

**RICAMBI IMMEDIATI  
IMMEDIATE PARTS**



CARTUCCIA CARTRIDGE



CARTUCCIA DEVIATRICE DIVERTER CARTRIDGE



CARTUCCIA TERMOSTATICA THERMOSTATIC CARTRIDGE



DEVIATORE DIVERTER



VITONE CERAMICO CERAMIC VALVE



AERATORE TONDO ROUND AERATOR



VITONE TRADIZIONALE TRADITIONAL VALVE

LAVABO

**4705/4/BS + 476001** pag. 32



BATTERIA LAVABO TRE FORI BOCCA GIREVOLE  
3 HOLE BASIN SWINGING SPOUT

**4705/S + 476001** pag. 32



MISCELATORE LAVABO MONOFORO  
BASIN MIXER

**4705/P/S + 476001** pag. 32



MISCELATORE LAVABO MONOFORO BOCCA  
PROLUNGATA  
BASIN MIXER EXTENDED SPOUT

**474015, 474016, 474017** pag. 32

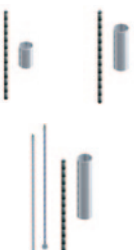

PROLUNGHE MISCELATORE LAVABO  
EXTENSIONS FOR BASIN

altezza mm 50 / high 50 mm: 474015  
altezza mm 100 / high 100 mm: 474016  
altezza mm 150 / high 150 mm: 474017

**4705/1 + 476001** pag. 33



MISCELATORE LAVABO MONOFORO ALTO BOCCA  
PROLUNGATA  
HIGHER BASIN MIXER EXTENDED SPOUT

**4705/6/E + 476001 + 054061** pag. 33



GRUPPO LAVABO A PARETE  
WALL BASIN MOUNTED GROUP



parti esterne / external parts: 4705/6/E  
maniglia / handle: 476001 x 2 pz  
parte incasso / built-in part: 054061

**4705/6/1E + 476001 + 054061** pag. 33



GRUPPO LAVABO A PARETE BOCCA PROLUNGATA  
WALL BASIN MOUNTED GROUP EXTENDED SPOUT



parti esterne / external parts: 4705/6/1E  
maniglia / handle: 476001 x 2 pz  
parte incasso / built-in part: 054061

**4705/3/BE + 476001 + 894001** pag. 33



MISCELATORE LAVABO DA PARETE BOCCA  
PROLUNGATA  
WALL BASIN EXTENDED SPOUT MIXER



parti esterne / external parts: 4705/3/BE  
maniglia / handle: 476001  
parte incasso / built-in part: 894001

**4705/3/CE + 476001 + 894001** pag. 34



MISCELATORE LAVABO DA PARETE BOCCA EXTRA  
PROLUNGATA  
WALL BASIN EXTRA EXTENDED SPOUT MIXER



parti esterne / external parts: 4705/3/CE  
maniglia / handle: 476001  
parte incasso / built-in part: 894001

**4705/3/2E + 476001 + 894001** pag. 34



MISCELATORE LAVABO DA PARETE SU PIASTRA  
BOCCA PROLUNGATA  
WALL BASIN MIXER EXTENDED SPOUT ON PLATE



parti esterne / external parts: 4705/3/2E  
maniglia / handle: 476001  
parte incasso / built-in part: 894001

**4705/3/3E + 476001 + 894001** pag. 34



MISCELATORE LAVABO DA PARETE SU PIASTRA  
BOCCA EXTRA PROLUNGATA  
WALL BASIN MIXER EXTRA EXTENDED SPOUT ON  
PLATE



parti esterne / external parts: 4705/3/3E  
maniglia / handle: 476001  
parte incasso / built-in part: 894001

**4705/R/A + 476001** pag. 34



MISCELATORE REMOTO  
REMOTE MIXER

**4705/R/BE + 476001 + 104033** pag. 35



MISCELATORE INCASSO REMOTO  
BUILT-IN REMOTE MIXER



parti esterne / external parts: 4705/R/BE  
maniglia / handle: 476001  
parte incasso / built-in part: 104033

**464008** pag. 35



BOCCA LAVABO DA PARETE L 185  
WALL WASH SPOUT L 185

**464014** pag. 35



BOCCA LAVABO DA PARETE L 215  
WALL WASH SPOUT L 215

**4705/1/B** pag. 35



BOCCA MONOFORO GIREVOLE  
SWINGING WASH SPOUT

**BIDET**

**4707/4/S + 476001** pag. 36

BATTERIA BIDET TRE FORI BOCCA GIREVOLE  
3 HOLE BIDET SWINGING SPOUT



**4707/S + 476001** pag. 36

MISCELATORE BIDET MONOFORO  
BIDET MIXER



**464003** pag. 36

BOCCA BIDET DA PARETE  
WALL BIDET SPOUT



**DOCCIA INCASSO**

**4721/E + 476001 + 104018** pag. 36

MISCELATORE INCASSO  
BUILT-IN MIXER



parti esterne / external parts: 4721/E  
maniglia / handle: 476001  
parte incasso / built-in part: 104018



**4700/E + 476001 + 104002** pag. 37

MISCELATORE INCASSO C/DEVIATORE 2 USCITE  
BUILT-IN MIXER WITH DIVERTER 2 OUT



parti esterne / external parts: 4700/E  
maniglia / handle: 476001  
parte incasso / built-in part: 104002



**DEVIATORI INCASSO**

**4703/2/1E + 476001 + 914016** pag. 37

DEVIATORE INCASSO 2 USCITE  
BUILT-IN DIVERTER 2 OUT



parti esterne / external parts: 4703/2/1E  
maniglia / handle: 476001  
parte incasso / built-in part: 914016



**4703/3/1E + 476001 + 034127** pag. 37

DEVIATORE INCASSO 3 USCITE  
BUILT-IN DIVERTER 3 OUT



parti esterne / external parts: 4703/3/1E  
maniglia / handle: 476001  
parte incasso / built-in part: 034127



**4703/4/1E + 476001 + 034128** pag. 37

DEVIATORE INCASSO 4 USCITE  
BUILT-IN DIVERTER 4 OUT



parti esterne / external parts: 4703/4/1E  
maniglia / handle: 476001  
parte incasso / built-in part: 034128



**DOCCIA INCASSO TERMOSTATICO**

**4712/PE + 476001 + 484020** pag. 38

MISCELATORE TERMOSTATICO INCASSO 1 USCITA  
BUILT-IN THERMOSTATIC MIXER 1 OUT



parti esterne / external parts: 4712/PE  
maniglia / handle: 476001  
parte incasso / built-in part: 484020



**4712/2/PE + 476001 + 484021** pag. 38

MISCELATORE TERMOSTATICO INCASSO C/DEVIATORE 2 USCITE  
BUILT-IN THERMOSTATIC MIXER WITH DIVERTER 2 OUT



parti esterne / external parts: 4712/2/PE  
maniglia / handle: 476001  
parte incasso / built-in part: 484021



**4712/3/PE + 476001 + 484022** pag. 38

MISCELATORE TERMOSTATICO INCASSO C/DEVIATORE 3 USCITE  
BUILT-IN THERMOSTATIC MIXER WITH DIVERTER 3 OUT



parti esterne / external parts: 4712/3/PE  
maniglia / handle: 476001  
parte incasso / built-in part: 484022



**4712/4/PE + 476001 + 484023** pag. 38

MISCELATORE TERMOSTATICO INCASSO C/DEVIATORE 4 USCITE  
BUILT-IN THERMOSTATIC MIXER WITH DIVERTER 4 OUT



parti esterne / external parts: 4712/4/PE  
maniglia / handle: 476001  
parte incasso / built-in part: 484023



**DOCCIA COMPLEMENTI**

**4403/1/A** pag. 39

SUPPORTO DOCCIA COMPLETO  
FULL SHOWER SUPPORT



**0530N** pag. 39

SALISCENDI COMPLETO C/PRESA D'ACQUA  
COMPLETE WALL PIPE WITH WATER CONNECTION





**DOCCIA COMPLEMENTI**



**0530/1N** pag. **39**

ASTA SALISCENDI  
WALL PIPE

**DOCCIA ESTERNO**

**4709/1 + 476001** pag. **40**



MISCELATORE DOCCIA ESTERNO  
EXTERNAL SHOWER MIXER

**VASCA**

**4701/A + 476001** pag. **40**



MISCELATORE VASCA ESTERNO  
EXTERNAL BATH MIXER

**4603** pag. **40**



BOCCA VASCA DA PARETE  
WALL BATH SPOUT

**BAGNO COMPLEMENTI**

**4708/E + 476001 + 054025** pag. **41**



RUBINETTO D'ARRESTO 1/2"  
BUILT-IN STOP COCK 1/2"



parti esterne / external parts: 4708/E  
maniglia / handle: 476001  
parte incasso / built-in part: 054025

**4708/E + 476001 + 054027** pag. **41**



RUBINETTO D'ARRESTO 3/4"  
BUILT-IN STOP COCK 3/4"



parti esterne / external parts: 4708/E  
maniglia / handle: 476001  
built-in part: 054027

**4740/E + 476001 + 654099** pag. **41**

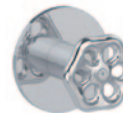

PASSO RAPIDO 3/4"  
BUILT-IN RAPID FLOW COCK 3/4"



parti esterne / external parts: 4740/E  
maniglia / handle: 476001  
parte incasso / built-in part: 654099

**4740/E + 476001 + 654100** pag. **41**



PASSO RAPIDO 1"  
BUILT-IN RAPID FLOW COCK 1"



parti esterne / external parts: 4740/E  
maniglia / handle: 476001  
parte incasso / built-in part: 654100

**4732/2/E + 476001 + 035212** pag. **42**



SARACINESCA  
GATE VALVE



parti esterne / external parts: 4732/2/E  
maniglia / handle: 476001  
parte incasso / built-in part: 035212

**ACCESSORI RUBINETTERIA**

**0133/L** pag. **42**



SIFONE LAVABO A BOTTIGLIA HI TECH 1"1/4  
ONE WAY BOTTLE "HI TECH" SIPHON TRAP FOR  
WASHBASIN 1"1/4

**0136/U** pag. **42**



SCARICO UNIVERSALE TONDO STOP&GO 1"1/4  
ALL-PURPOSE ROUND POP-UP WASTE 1"1/4

**020** pag. **42**



RUBINETTO SOTTOLAVABO CON FILTRO  
ANGLE VALVE WITH FILTER

**029** pag. **43**



TUBETTO CON CALOTTA 1/2"F  
PIPE WITH NUT 1/2"F

## 4705/4/BS + 476001

[batteria]

[maniglia]



rosso B1

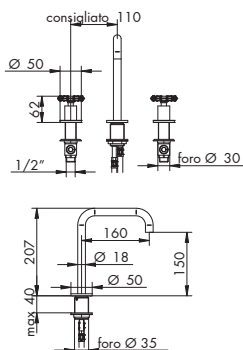

## BATTERIA LAVABO 3 FORI BOCCA ALTA GIREVOLE

- > vitone ceramico 90°
- > interasse bocca 160
- > bocca girevole 360°
- > limitatore di portata 5 l/min 3bar
- > senza flessibili di alimentazione
- > senza scarico
- > cod. B1 = rosso fabrique

	0136/U cromato € 58,00 p. 41
	605007 € 20,00 p. 151 - list. ricambi
	454038 € 10,00 p. 141 - list. ricambi

## CROMATO / MAN. CROMATO o ROSSO B1

01-4705/4/BS	€ 340,00
01-476001 o B1-476001	€ 2 x 58,00

PREZZO TOTALE € 456,00

## CROMATO / MANIGLIA IN ALTRA FINITURA

01-4705/4/BS	€ 340,00
XX-476001	€ 2 x 58,00 x M*

## ALTRE FINITURE

XX-4705/4/BS	€ 340,00 x M*
XX-476001	€ 2 x 58,00 x M*

## 4705/S + 476001

[mix]

[maniglia]



rosso B1

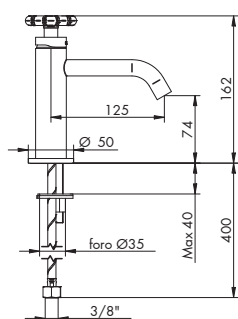

## MISCELATORE LAVABO MONOFORO

- > cartuccia tradizionale
- > interasse bocca 125
- > limitatore di portata 5 l/min 3bar
- > flessibili di alimentazione
- > senza scarico
- > cod. B1 = rosso fabrique

	0136/U cromato € 58,00 p. 41
	455039 € 47,00 p. 150 - list. ricambi
	454038 € 10,00 p. 141 - list. ricambi

## CROMATO / MAN. CROMATO o ROSSO B1

01-4705/S	€ 194,00
01-476001 o B1-476001	€ 58,00

PREZZO TOTALE € 252,00

## CROMATO / MANIGLIA IN ALTRA FINITURA

01-4705/S	€ 194,00
XX-476001	€ 58,00 x M*

## ALTRE FINITURE

XX-4705/S	€ 194,00 x M*
XX-476001	€ 58,00 x M*

## 4705/P/S + 476001

[mix]

[maniglia]



rosso B1

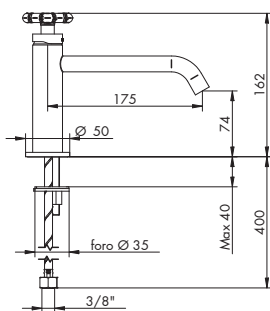

## MISCELATORE LAVABO MONOFORO BOCCA PROLUNGATA

- > cartuccia tradizionale
- > interasse bocca 175
- > limitatore di portata 5 l/min 3bar
- > flessibili di alimentazione
- > senza scarico
- > cod. B1 = rosso fabrique

	0136/U cromato € 58,00 p. 41
	455039 € 47,00 p. 150 - list. ricambi
	454038 € 10,00 p. 141 - list. ricambi

## CROMATO / MAN. CROMATO o ROSSO B1

01-4705/P/S	€ 204,00
01-476001 o B1-476001	€ 58,00

PREZZO TOTALE € 262,00

## CROMATO / MANIGLIA IN ALTRA FINITURA

01-4705/P/S	€ 204,00
XX-476001	€ 58,00 x M*

## ALTRE FINITURE

XX-4705/P/S	€ 204,00 x M*
XX-476001	€ 58,00 x M*

## 474015 | 474016 | 474017

## PROLUNGHE MISCELATORE LAVABO

- > diametro 34 mm
- > altezza 50 mm, 100 mm, 150 mm

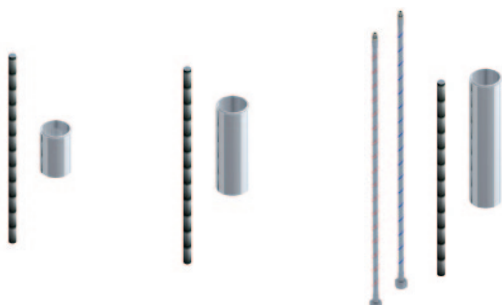

## CROMATO

01-474015	50 mm	€ 52,00
01-474016	100 mm	€ 67,00
01-474017	150 mm	€ 111,00

## ALTRE FINITURE

XX-474015	50 mm	€ 52,00 x M*
XX-474016	100 mm	€ 67,00 x M*
XX-474017	150 mm	€ 111,00 x M*

SCARICO C/TAPPO  
A PRESSIONE

CARTUCCIA

AERATORE  
TONDOVITONE  
CERAMICO

## 4705/1 + 476001

[mix] [maniglia]



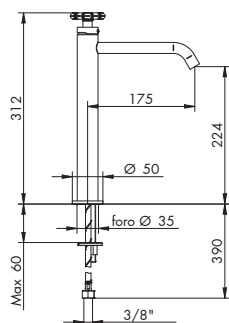

rosso B1



## MISCELATORE LAVABO MONOFORO ALTO BOCCA PROLUNGATA

- > cartuccia tradizionale
- > interasse bocca 175
- > limitatore di portata 5 l/min 3bar
- > flessibili di alimentazione
- > senza scarico
- > cod. B1 = rosso fabrique

	0136/U cromato € 58,00 p. 41
	455039 € 47,00 p. 150 - list. ricambi
	454038 € 10,00 p. 141 - list. ricambi

CROMATO / MAN. CROMATO o ROSSO B1	
01-4705/1	€ 299,00
01-476001 o B1-476001	€ 58,00
<b>PREZZO TOTALE</b>	<b>€ 357,00</b>

CROMATO / MANIGLIA IN ALTRA FINITURA	
01-4705/1	€ 299,00
XX-476001	€ 58,00 x M*

ALTRE FINITURE	
XX-4705/1	€ 299,00 x M*
XX-476001	€ 58,00 x M*

## 4705/6/E + 476001 + 054061

[parte esterna] [maniglia] [parte incasso]



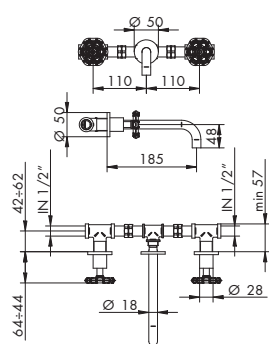

rosso B1



## GRUPPO LAVABO DA PARETE

- > vitone ceramico 90°
- > interasse bocca 185
- > limitatore di portata 5 l/min 3bar
- > ingressi da 1/2"
- > senza scarico
- > cod. B1 = rosso fabrique

	0136/U cromato € 58,00 p. 41
	055001 € 20,00 p. 151 - list. ricambi
	454038 € 10,00 p. 141 - list. ricambi

P. EST. - CROMATO / MAN. CROMATO o ROSSO B1	
01-4705/6/E	€ 190,00
01-476001 o B1-476001	€ 2 x 58,00

P. EST. - CROMATO / MAN. IN ALTRA FINITURA	
01-4705/6/E	€ 190,00
XX-476001	€ 2 x 58,00 x M*

PARTE INCASSO	
054061	€ 116,00
<b>PREZZO TOTALE</b>	<b>€ 422,00</b>

PARTI ESTERNE - ALTRE FINITURE	
XX-4705/6/E	€ 190,00 x M*
XX-476001	€ 2 x 58,00 x M*

## 4705/6/1E + 476001 + 054061

[parte esterna] [maniglia] [parte incasso]



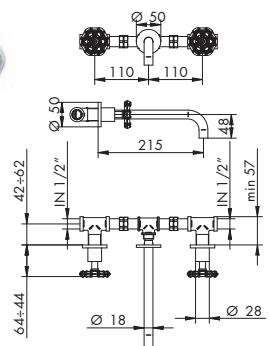

rosso B1



## GRUPPO LAVABO DA PARETE BOCCA PROLUNGATA

- > vitone ceramico 90°
- > interasse bocca 215
- > limitatore di portata 5 l/min 3bar
- > ingressi da 1/2"
- > senza scarico
- > cod. B1 = rosso fabrique

	0136/U cromato € 58,00 p. 41
	055001 € 20,00 p. 151 - list. ricambi
	454038 € 10,00 p. 141 - list. ricambi

P. EST. - CROMATO / MAN. CROMATO o ROSSO B1	
01-4705/6/1E	€ 203,00
01-476001 o B1-476001	€ 2 x 58,00

P. EST. - CROMATO / MAN. IN ALTRA FINITURA	
01-4705/6/1E	€ 203,00
XX-476001	€ 2 x 58,00 x M*

PARTE INCASSO	
054061	€ 116,00
<b>PREZZO TOTALE</b>	<b>€ 435,00</b>

PARTI ESTERNE - ALTRE FINITURE	
XX-4705/6/1E	€ 203,00 x M*
XX-476001	€ 2 x 58,00 x M*

## 4705/3/BE + 476001 + 894001

[parte esterna] [maniglia] [parte incasso]



rosso B1

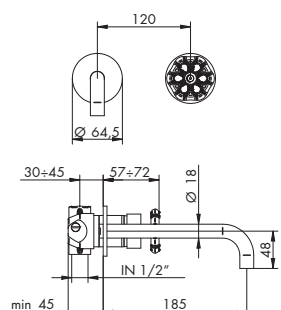

## MISCELATORE LAVABO DA PARETE BOCCA PROLUNGATA

- > cartuccia tradizionale
- > interasse bocca 185
- > limitatore di portata 5 l/min 3bar
- > ingressi da 1/2"
- > senza scarico
- > rosoni separati
- > cod. B1 = rosso fabrique

	0136/U cromato € 58,00 p. 41
	025002 € 30,00 p. 149 - list. ricambi
	454038 € 10,00 p. 141 - list. ricambi

P. EST. - CROMATO / MAN. CROMATO o ROSSO B1	
01-4705/3/BE	€ 150,00
01-476001 o B1-476001	€ 58,00

P. EST. - CROMATO / MAN. IN ALTRA FINITURA	
01-4705/3/BE	€ 150,00
XX-476001	€ 58,00 x M*

PARTE INCASSO	
01-894001	€ 105,00
<b>PREZZO TOTALE</b>	<b>€ 313,00</b>

PARTI ESTERNE - ALTRE FINITURE	
XX-4705/3/BE	€ 150,00 x M*
XX-476001	€ 58,00 x M*

**4705/3/CE + 476001 + 894001**

[parte esterna] [maniglia] [parte incasso]

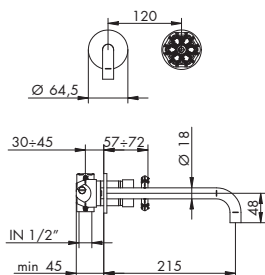

rosso B1

**MISCELATORE LAVABO DA PARETE BOCCA EXTRA PROLUNGATA**

- > cartuccia tradizionale
- > interasse bocca 215
- > limitatore di portata 5l/min 3bar
- > ingressi da 1/2"
- > senza scarico
- > rosoni separati
- > cod. B1 = rosso fabrique



P. EST. - CROMATO / MAN. CROMATO o ROSSO B1	
01-4705/3/CE	€ 163,00
01-476001 o B1-476001	€ 58,00
PARTE INCASSO	
01-894001	€ 105,00
<b>PREZZO TOTALE</b>	<b>€ 326,00</b>

P. EST. - CROMATO / MAN. IN ALTRA FINITURA	
01-4705/3/CE	€ 163,00
<b>XX-476001</b>	<b>€ 58,00 x M*</b>
PARTI ESTERNE - ALTRE FINITURE	
<b>XX-4705/3/CE</b>	<b>€ 163,00 x M*</b>
<b>XX-476001</b>	<b>€ 58,00 x M*</b>

**4705/3/2E + 476001 + 894001**

[parte esterna] [maniglia] [parte incasso]

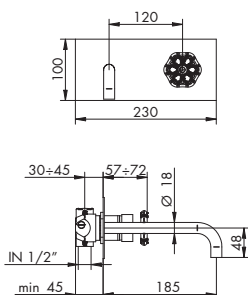

rosso B1

**MISCELATORE LAVABO DA PARETE BOCCA PROLUNGATA SU PIASTRA**

- > cartuccia tradizionale
- > interasse bocca 185
- > limitatore di portata 5l/min 3bar
- > ingressi da 1/2"
- > senza scarico
- > piastra unica rettangolare
- > cod. B1 = rosso fabrique



P. EST. - CROMATO / MAN. CROMATO o ROSSO B1	
01-4705/3/2E	€ 224,00
01-476001 o B1-476001	€ 58,00
PARTE INCASSO	
01-894001	€ 105,00
<b>PREZZO TOTALE</b>	<b>€ 387,00</b>

P. EST. - CROMATO / MAN. IN ALTRA FINITURA	
01-4705/3/2E	€ 224,00
<b>XX-476001</b>	<b>€ 58,00 x M*</b>
PARTI ESTERNE - ALTRE FINITURE	
<b>XX-4705/3/2E</b>	<b>€ 224,00 x M*</b>
<b>XX-476001</b>	<b>€ 58,00 x M*</b>

**4705/3/3E + 476001 + 894001**

[parte esterna] [maniglia] [parte incasso]

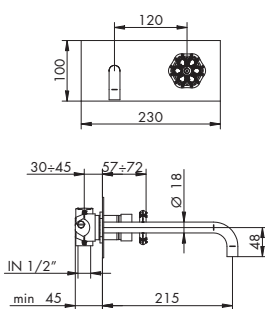

rosso B1

**MISCELATORE LAVABO DA PARETE BOCCA EXTRA PROLUNGATA SU PIASTRA**

- > cartuccia tradizionale
- > interasse bocca 215
- > limitatore di portata 5l/min 3bar
- > ingressi da 1/2"
- > senza scarico
- > piastra unica rettangolare
- > cod. B1 = rosso fabrique



P. EST. - CROMATO / MAN. CROMATO o ROSSO B1	
01-4705/3/3E	€ 237,00
01-476001 o B1-476001	€ 58,00
PARTE INCASSO	
01-894001	€ 105,00
<b>PREZZO TOTALE</b>	<b>€ 400,00</b>

P. EST. - CROMATO / MAN. IN ALTRA FINITURA	
01-4705/3/3E	€ 237,00
<b>XX-476001</b>	<b>€ 58,00 x M*</b>
PARTI ESTERNE - ALTRE FINITURE	
<b>XX-4705/3/3E</b>	<b>€ 237,00 x M*</b>
<b>XX-476001</b>	<b>€ 58,00 x M*</b>

**4705/R/A + 476001**

[mix] [maniglia]

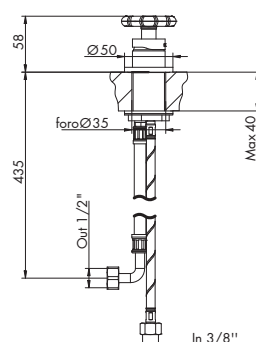

rosso B1

**MISCELATORE REMOTO**

- > cartuccia tradizionale
- > flessibili di alimentazione
- > senza scarico
- > cod. B1 = rosso fabrique

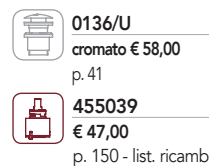

CROMATO / MAN. CROMATO o ROSSO B1	
01-4705/R/A	€ 225,00
01-476001 o B1-476001	€ 58,00
<b>PREZZO TOTALE</b>	<b>€ 283,00</b>

CROMATO / MANIGLIA IN ALTRA FINITURA	
01-4705/R/A	€ 225,00
<b>XX-476001</b>	<b>€ 58,00 x M*</b>
ALTRE FINITURE	
<b>XX-4705/R/A</b>	<b>€ 225,00 x M*</b>
<b>XX-476001</b>	<b>€ 58,00 x M*</b>

**4705/R/BE + 476001 + 104033**

[parte esterna] [maniglia] [parte incasso]

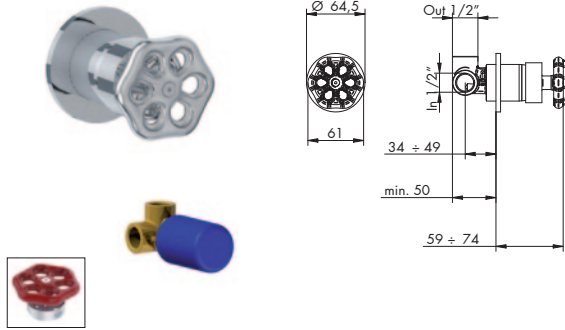

rosso B1

**MISCELATORE INCASSO REMOTO**

- > cartuccia tradizionale
- > ingressi da 1/2"
- > uscita superiore
- > senza scarico
- > cod. B1 = rosso fabrique

 **0136/U**  
cromato € 58,00  
p. 41

 **025002**  
€ 30,00  
p. 149 - list. ricambi

P. EST. - CROMATO / MAN. CROMATO o ROSSO B1	
01-4705/R/BE	€ 90,00
01-476001 o B1-476001	€ 58,00
PARTE INCASSO	
01-104033	€ 113,00
<b>PREZZO TOTALE</b>	<b>€ 261,00</b>

P. EST. - CROMATO / MAN. IN ALTRA FINITURA	
01-4705/R/BE	€ 90,00
<b>XX-476001</b>	<b>€ 58,00 x M*</b>

PARTI ESTERNE - ALTRE FINITURE	
<b>XX-4705/R/BE</b>	<b>€ 90,00 x M*</b>
<b>XX-476001</b>	<b>€ 58,00 x M*</b>

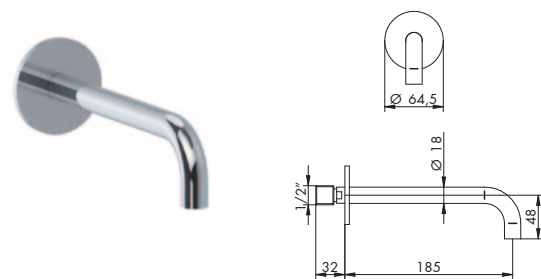
**464008****BOCCA LAVABO DA PARETE**

- > interasse bocca 185
- > limitatore di portata 5 l/min 3 bar
- > attacco da 1/2"
- > rosone tondo

 **0136/U**  
cromato € 58,00  
p. 41

 **454038**  
€ 10,00  
p. 141 - list. ricambi

CROMATO	
01-464008	€ 90,00

ALTRE FINITURE	
<b>XX-464008</b>	<b>€ 90,00 x M*</b>

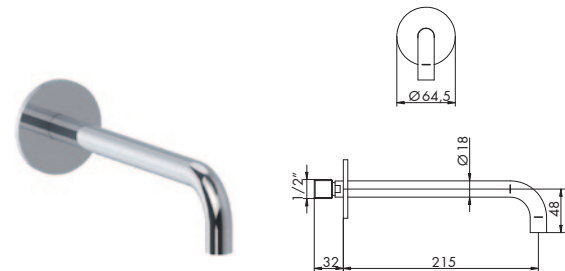
**464014****BOCCA LAVABO DA PARETE**

- > interasse bocca 215
- > limitatore di portata 5 l/min 3 bar
- > attacco da 1/2"
- > rosone tondo

 **0136/U**  
cromato € 58,00  
p. 41

 **454038**  
€ 10,00  
p. 141 - list. ricambi

CROMATO	
01-464014	€ 106,00

ALTRE FINITURE	
<b>XX-464014</b>	<b>€ 106,00 x M*</b>

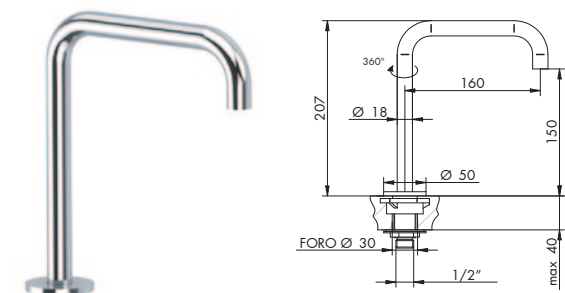
**4705/1/B****BOCCA MONOFORO GIREVOLE**

- > interasse bocca 160
- > bocca girevole 360°
- > limitatore di portata 5 l/min 3bar
- > attacco da 1/2"

 **0136/U**  
cromato € 58,00  
p. 41

 **454038**  
€ 10,00  
p. 141 - list. ricambi

CROMATO	
01-4705/1/B	€ 198,00

ALTRE FINITURE	
<b>XX-4705/1/B</b>	<b>€ 198,00 x M*</b>

**4707/4/S + 476001**

[batteria] [maniglia]



rosso B1

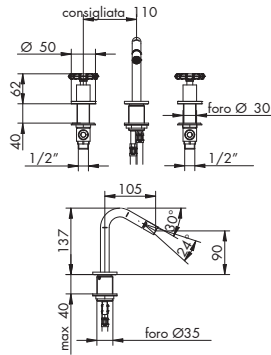

**BATTERIA BIDET 3 FORI BOCCA GIREVOLE**

- > vitone ceramico 90°
- > interasse bocca 105
- > bocca girevole 360°
- > limitatore di portata 5 l/min 3 Bar
- > aeratore snodato
- > senza flessibili di alimentazione
- > senza scarico
- > cod. B1 = rosso fabrique

<b>CROMATO / MAN. CROMATO o ROSSO B1</b>	
01-4707/4/S	€ 340,00
01-476001 o B1-476001	€ 2 x 58,00

**PREZZO TOTALE € 456,00**

<b>CROMATO / MANIGLIA IN ALTRA FINITURA</b>	
01-4707/4/S	€ 340,00
XX-476001	€ 2 x 58,00 x M*

<b>ALTRE FINITURE</b>	
XX-4707/4/S	€ 340,00 x M*
XX-476001	€ 2 x 58,00 x M*

- 0136/U cromato € 58,00 p. 41
- 605007 € 20,00 p. 151 - list. ricambi
- 454038 € 10,00 p. 141 - list. ricambi

**4707/S + 476001**

[mix] [maniglia]



rosso B1

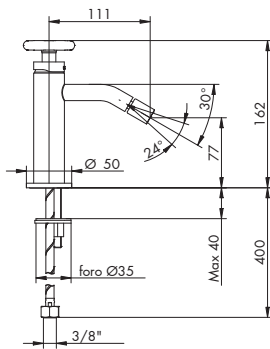

**MISCELATORE BIDET MONOFORO**

- > cartuccia tradizionale
- > interasse bocca 111
- > aeratore snodato
- > limitatore di portata 5 l/min 3 Bar
- > flessibili di alimentazione
- > senza scarico
- > cod. B1 = rosso fabrique

<b>CROMATO / MAN. CROMATO o ROSSO B1</b>	
01-4707/S	€ 194,00
01-476001 o B1-476001	€ 58,00

**PREZZO TOTALE € 252,00**

<b>CROMATO / MANIGLIA IN ALTRA FINITURA</b>	
01-4707/S	€ 194,00
XX-476001	€ 58,00 x M*

<b>ALTRE FINITURE</b>	
XX-4707/S	€ 194,00 x M*
XX-476001	€ 58,00 x M*

- 0136/U cromato € 58,00 p. 41
- 455039 € 47,00 p. 150 - list. ricambi
- 454038 € 10,00 p. 141 - list. ricambi

**464003**

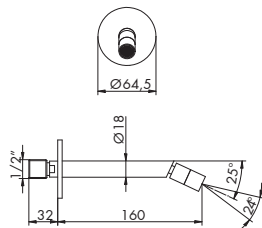

**BOCCA BIDET DA PARETE**

- > interasse bocca 160
- > aeratore snodato
- > attacco da 1/2"
- > rosone tondo

<b>CROMATO</b>	
01-464003	€ 129,00

<b>ALTRE FINITURE</b>	
XX-464003	€ 129,00 x M*

- 0136/U cromato € 58,00 p. 41
- 014076 cromato € 24,00 rosso B1 € 36,00 p. 140 - list. ricambi

**4721/E + 476001 + 104018**

[parte esterna] [maniglia] [parte incasso]



rosso B1

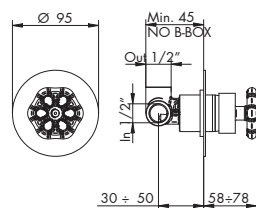

**MISCELATORE INCASSO**

- > cartuccia tradizionale
- > ingressi da 1/2"
- > uscita superiore
- > incasso c/b-box
- > cod. B1 = rosso fabrique

<b>P. EST. - CROMATO / MAN. CROMATO o ROSSO B1</b>	
01-4721/E	€ 87,00
01-476001 o B1-476001	€ 58,00

<b>PARTE INCASSO</b>	
01-104018	€ 113,00
<b>PREZZO TOTALE</b>	<b>€ 258,00</b>

<b>P. EST. - CROMATO / MAN. IN ALTRA FINITURA</b>	
01-4721/E	€ 87,00
XX-476001	€ 58,00 x M*

<b>PARTI ESTERNE - ALTRE FINITURE</b>	
XX-4721/E	€ 87,00 x M*
XX-476001	€ 58,00 x M*

- 025002 € 30,00 p. 149 - list. ricambi

## 4700/E + 476001 + 104002

[parte esterna] [maniglia] [parte incasso]

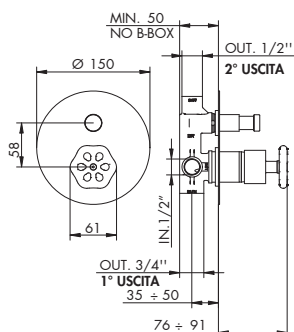
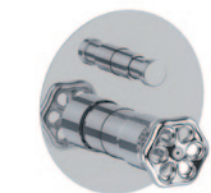

rosso B1



## MISCELATORE INCASSO C/DEVIATORE 2 USCITE

- > cartuccia tradizionale
- > deviatore a pressione 2 uscite c/ritorno automatico e blocco meccanico basse pressioni
- > attacchi da 1/2"
- > uscita principale inferiore da 3/4"
- > incasso c/b-box
- > cod. B1 = rosso fabrique



025002

€ 30,00

p. 149 - list. ricambi



105029

€ 38,00

p. 131 - list. ricambi

## P. EST. - CROMATO / MAN. CROMATO o ROSSO B1

01-4700/E € 103,00

01-476001 o B1-476001 € 58,00

## P. EST. - CROMATO / MAN. IN ALTRA FINITURA

01-4700/E € 103,00

XX-476001 € 58,00 x M\*

## PARTE INCASSO

01-104002 € 231,00

PREZZO TOTALE € 392,00

## PARTI ESTERNE - ALTRE FINITURE

XX-4700/E € 103,00 x M\*

XX-476001 € 58,00 x M\*

## 4703/2/1E + 476001 + 914016

[parte esterna] [maniglia] [parte incasso]

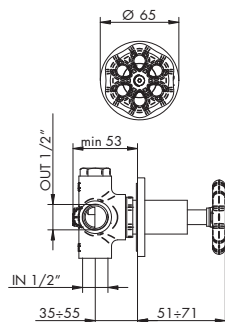
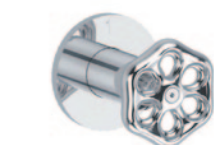

rosso B1

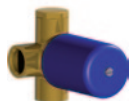

## DEVIATORE INCASSO 2 USCITE

- > deviatore a dischi ceramici 2 uscite senza chiusura
- > attacchi da 1/2"
- > cod. B1 = rosso fabrique



635010

€ 49,00

p. 131 - list. ricambi

## P. EST. - CROMATO / MAN. CROMATO o ROSSO B1

01-4703/2/1E € 113,00

01-476001 o B1-476001 € 58,00

## P. EST. - CROMATO / MAN. IN ALTRA FINITURA

01-4703/2/1E € 113,00

XX-476001 € 58,00 x M\*

## PARTE INCASSO

914016 € 85,00

PREZZO TOTALE € 256,00

## PARTI ESTERNE - ALTRE FINITURE

XX-4703/2/1E € 113,00 x M\*

XX-476001 € 58,00 x M\*

## 4703/3/1E + 476001 + 034127

[parte esterna] [maniglia] [parte incasso]

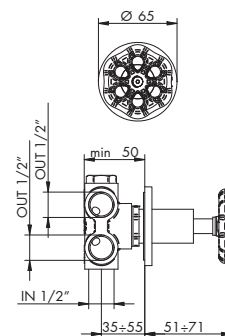
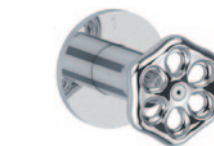

rosso B1

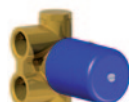

## DEVIATORE INCASSO 3 USCITE

- > deviatore a dischi ceramici 3 uscite senza chiusura
- > attacchi da 1/2"
- > cod. B1 = rosso fabrique



635011

€ 49,00

p. 131 - list. ricambi

## P. EST. - CROMATO / MAN. CROMATO o ROSSO B1

01-4703/3/1E € 113,00

01-476001 o B1-476001 € 58,00

## P. EST. - CROMATO / MAN. IN ALTRA FINITURA

01-4703/3/1E € 113,00

XX-476001 € 58,00 x M\*

## PARTE INCASSO

034127 € 118,00

PREZZO TOTALE € 289,00

## PARTI ESTERNE - ALTRE FINITURE

XX-4703/3/1E € 113,00 x M\*

XX-476001 € 58,00 x M\*

## 4703/4/1E + 476001 + 034128

[parte esterna] [maniglia] [parte incasso]

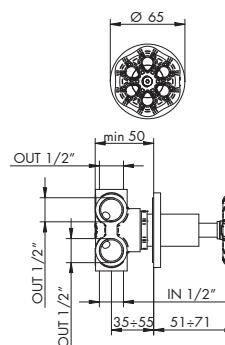

rosso B1



## DEVIATORE INCASSO 4 USCITE

- > deviatore a dischi ceramici 4 uscite senza chiusura
- > attacchi da 1/2"
- > cod. B1 = rosso fabrique



635012

€ 49,00

p. 131 - list. ricambi

## P. EST. - CROMATO / MAN. CROMATO o ROSSO B1

01-4703/4/1E € 113,00

01-476001 o B1-476001 € 58,00

## P. EST. - CROMATO / MAN. IN ALTRA FINITURA

01-4703/4/1E € 113,00

XX-476001 € 58,00 x M\*

## PARTE INCASSO

034128 € 131,00

PREZZO TOTALE € 302,00

## PARTI ESTERNE - ALTRE FINITURE

XX-4703/4/1E € 113,00 x M\*

XX-476001 € 58,00 x M\*

## RICAMBI IMMEDIATI



CARTUCCIA



CARTUCCIA DEVIATRICE



DEVIATORE

XX = CODICE FINITURA RICHIESTA: per identificare codice corretto vedi pag. 26  
 M\* = MOLTIPLICATORE: per calcolare il prezzo delle altre finiture vedi tabella pag. 26

## 4712/PE + 476001 + 484020

[parte esterna] [maniglia] [parte incasso]

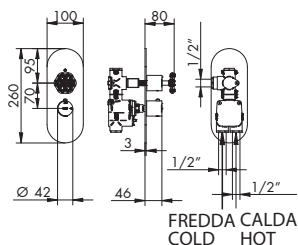

rosso B1

FREDDA CALDA  
COLD HOT

## MISCELATORE TERMOSTATICO INCASSO 1 USCITA

- > cartuccia termostatica
- > vitone ceramico 90°
- > apertura con rotazione antioraria
- > interasse 70 mm
- > ingressi inferiori da 1/2"
- > incasso con B-Box
- > posizionabile orizzontalmente
- > 2 maniglie
- > cod. B1 = rosso fabrique
- > uscita laterale destra da 1/2"
- > incasso regolabile min 76
- > piastra unica

775007  
€ 61,00  
p. 220 - list. ricambi055134  
€ 68,00  
p. 220 - list. ricambi

## P. EST. - CROMATO / MAN. CROMATO o ROSSO B1

01-4712/PE € 332,00  
01-476001 o B1-476001 € 58,00

## P. EST. - CROMATO / MAN. IN ALTRA FINITURA

01-4712/PE € 332,00  
XX-476001 € 58,00 x M\*

## PARTE INCASSO

484020 € 452,00

## PARTI ESTERNE - ALTRE FINITURE

XX-4712/PE € 332,00 x M\*  
XX-476001 € 58,00 x M\*

PREZZO TOTALE € 842,00

## 4712/2/PE + 476001 + 484021

[parte esterna] [maniglia] [parte incasso]

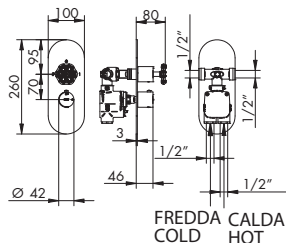

rosso B1

FREDDA CALDA  
COLD HOT

## MISCELATORE TERMOSTATICO INCASSO C/DEVIATORE 2 USCITE

- > cartuccia termostatica
- > deviatore a dischi ceramici 2 uscite c/chiusura
- > interasse 70 mm
- > ingressi inferiori da 1/2"
- > incasso con B-Box
- > piastra unica
- > 2 maniglie
- > cod. B1 = rosso fabrique
- > uscite laterali da 1/2"
- > incasso regolabile min 76

775007  
€ 61,00  
p. 220 - list. ricambi035346  
€ 49,00  
p. 212 - list. ricambi

## P. EST. - CROMATO / MAN. CROMATO o ROSSO B1

01-4712/2/PE € 332,00  
01-476001 o B1-476001 € 58,00

## P. EST. - CROMATO / MAN. IN ALTRA FINITURA

01-4712/2/PE € 332,00  
XX-476001 € 58,00 x M\*

## PARTE INCASSO

484021 € 478,00

## PARTI ESTERNE - ALTRE FINITURE

XX-4712/2/PE € 332,00 x M\*  
XX-476001 € 58,00 x M\*

PREZZO TOTALE € 868,00

## 4712/3/PE + 476001 + 484022

[parte esterna] [maniglia] [parte incasso]

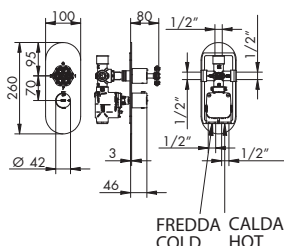

rosso B1

FREDDA CALDA  
COLD HOT

## MISCELATORE TERMOSTATICO INCASSO C/DEVIATORE 3 USCITE

- > cartuccia termostatica
- > deviatore a dischi ceramici 3 uscite c/chiusura
- > interasse 70 mm
- > ingressi inferiori da 1/2"
- > uscite laterali e superiore da 1/2"
- > incasso con B-Box
- > piastra unica
- > cod. B1 = rosso fabrique
- > incasso regolabile min 76
- > 2 maniglie

775007  
€ 61,00  
p. 220 - list. ricambi035345  
€ 49,00  
p. 212 - list. ricambi

## P. EST. - CROMATO / MAN. CROMATO o ROSSO B1

01-4712/3/PE € 332,00  
01-476001 o B1-476001 € 58,00

## P. EST. - CROMATO / MAN. IN ALTRA FINITURA

01-4712/3/PE € 332,00  
XX-476001 € 58,00 x M\*

## PARTE INCASSO

484022 € 531,00

## PARTI ESTERNE - ALTRE FINITURE

XX-4712/3/PE € 332,00 x M\*  
XX-476001 € 58,00 x M\*

PREZZO TOTALE € 921,00

## 4712/4/PE + 476001 + 484023

[parte esterna] [maniglia] [parte incasso]

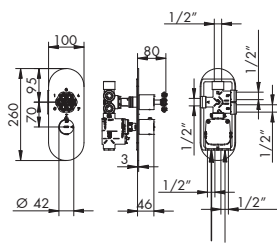

rosso B1

FREDDA CALDA  
COLD HOT

## MISCELATORE TERMOSTATICO INCASSO C/DEVIATORE 4 USCITE

- > cartuccia termostatica
- > deviatore a dischi ceramici 4 uscite c/doppia chiusura
- > interasse 70 mm
- > ingressi inferiori da 1/2"
- > uscite laterali e superiore da 1/2"
- > incasso in ottone con B-Box
- > piastra unica
- > cod. B1 = rosso fabrique
- > incasso regolabile min 76
- > 2 maniglie

775007  
€ 61,00  
p. 220 - list. ricambi035344  
€ 49,00  
p. 212 - list. ricambi

## P. EST. - CROMATO / MAN. CROMATO o ROSSO B1

01-4712/4/PE € 332,00  
01-476001 o B1-476001 € 58,00

## P. EST. - CROMATO / MAN. IN ALTRA FINITURA

01-4712/4/PE € 332,00  
XX-476001 € 58,00 x M\*

## PARTE INCASSO

484023 € 585,00

## PARTI ESTERNE - ALTRE FINITURE

XX-4712/4/PE € 332,00 x M\*  
XX-476001 € 58,00 x M\*

PREZZO TOTALE € 975,00

CARTUCCIA  
TERMOSTATICAVITONE  
CERAMICOCARTUCCIA  
DEVIATRICE



PER COMANDI TERMOSTATICI ALTA PORTATA, CONSULTARE LISTINO REVIVRE DA PAG. 187.

FOR HIGH FLOW RATE THERMOSTATIC MIXER, LOOK AT THE "REVIVRE" PRICE LIST FROM PAGE 187.



8812/H/P/E  
+ 774035



8812/2H/P/E  
+ 774036



8812/3H/P/E  
+ 774033



8812/4H/P/E  
+ 774034



8812/H/E  
+ 884036



8812/2H/E  
+ 884037



8812/3H/E  
+ 884038



8812/4H/E  
+ 884039

#### 4403/1/A

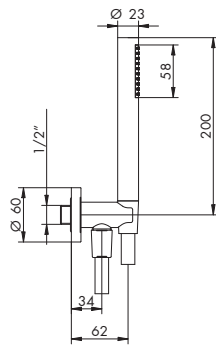

#### SUPPORTO DOCCIA COMPLETO

- > flessibile in PVC 150 cm
- > presa acqua con supporto fisso
- > attacchi da 1/2"
- > doccetta monogetto cilindrica in abs c/anticalcare
- > per finiture diverse da cromo doccetta in metallo

#### CROMATO

01-4403/1/A

€ 130,00

#### ALTRE FINITURE

XX-4403/1/A

€ 130,00 x M\*

#### 0530N

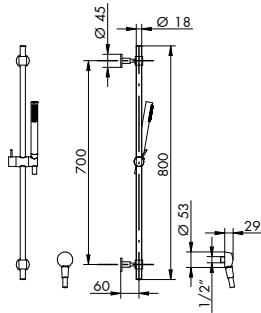

#### SALISCENDI COMPLETO C/PRESA D'ACQUA

- > flessibile in PVC 150 cm
- > supporto doccetta scorrevole orientabile
- > presa acqua da 1/2"
- > doccetta monogetto cilindrica in ABS c/anticalcare, per finiture diverse da cromo doccetta in metallo

#### CROMATO

01-0530N

€ 352,00

#### ALTRE FINITURE

XX-0530N

€ 352,00 x M\*

#### 0530/1N

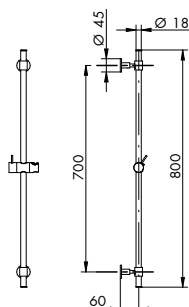

#### ASTA SALISCENDI

- > supporto doccetta scorrevole orientabile

#### CROMATO

01-0530/1N

€ 230,00

#### ALTRE FINITURE

XX-0530/1N

€ 230,00 x M\*

PER SOLUZIONI ALTERNATIVE, CONSULTARE LISTINO REVIVRE DA PAG. 119, SEZIONE COMPLETA DOCCIA COMPLEMENTI.

FOR ALTERNATIVE SOLUTIONS, SEE THE REVIVRE PRICE LIST FROM PAGE 119, TO LOOK AT THE COMPLETE "DOCCIA COMPLEMENTI" COLLECTION.

PER COMPOSIZIONI DOCCIA CONSULTARE LISTINO REVIVRE.

FOR SHOWER TYPESETTING LOOK AT "REVIVRE" PRICE LIST.

### 4709/1 + 476001

[mix] [maniglia]

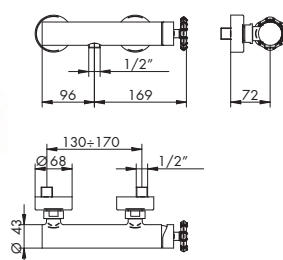

rosso B1

### MISCELATORE DOCCIA ESTERNO

- > cartuccia tradizionale
- > senza set doccia
- > attacchi da 1/2"
- > cod. B1 = rosso fabrique



025002  
€ 30,00  
p. 149 - list. ricambi

#### CROMATO / MAN. CROMATO o ROSSO B1

01-4709/1	€ 333,00
01-476001 o B1-476001	€ 58,00

PREZZO TOTALE € 391,00

#### CROMATO / MANIGLIA IN ALTRA FINITURA

01-4709/1	€ 333,00
XX-476001	€ 58,00 x M*

#### ALTRE FINITURE

XX-4709/1	€ 333,00 x M*
XX-476001	€ 58,00 x M*

### 4701/A + 476001

[mix] [maniglia]

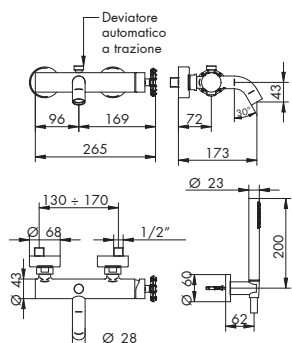

rosso B1

### MISCELATORE VASCA ESTERNO

- > cartuccia tradizionale
- > interasse bocca 173
- > deviatore a trazione con ritorno automatico e blocco per basse pressioni
- > flessibile in PVC 150 cm
- > supporto a parete fisso > attacchi da 1/2"
- > doccetta monogetto cilindrica in ABS c/anticalcare
- > per finiture diverse da cromo doccetta in metallo
- > cod. B1 = rosso fabrique



025002  
€ 30,00  
p. 149 - list. ricambi



045057  
cromato € 27,00  
rosso B1 € 40,00  
p. 131 - list. ricambi

#### CROMATO / MAN. CROMATO o ROSSO B1

01-4701/A	€ 414,00
01-476001 o B1-476001	€ 58,00

PREZZO TOTALE € 472,00

#### CROMATO / MANIGLIA IN ALTRA FINITURA

01-4701/A	€ 414,00
XX-476001	€ 58,00 x M*

#### ALTRE FINITURE

XX-4701/A	€ 414,00 x M*
XX-476001	€ 58,00 x M*

### 4603

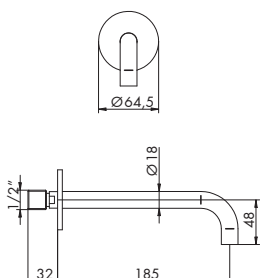

### BOCCA VASCA DA PARETE

- > interasse bocca 185
- > attacchi da 1/2"



254003  
€ 8,00  
p. 141 - list. ricambi

#### CROMATO

01-4603	€ 85,00
---------	---------

#### ALTRE FINITURE

XX-4603	€ 85,00 x M*
---------	--------------



**4708/E + 476001 + 054025**

[parte esterna] [maniglia] [parte incasso]

**RUBINETTO D'ARRESTO 1/2"**

> vitone ceramico 90°  
> ingressi da 1/2"  
> cod. B1 = rosso fabrique

 055001  
€ 20,00  
p. 151 - list. ricambi

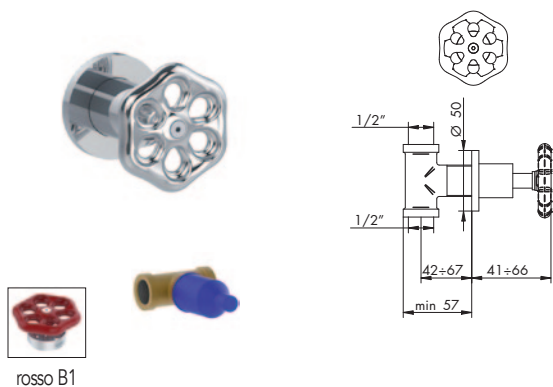

rosso B1

P. EST. - CROMATO / MAN. CROMATO o ROSSO B1	
01-4708/E	€ 60,00
01-476001 o B1-476001	€ 58,00
PARTE INCASSO	
054025	€ 45,00
<b>PREZZO TOTALE</b>	<b>€ 163,00</b>

P. EST. - CROMATO / MAN. IN ALTRA FINITURA	
01-4708/E	€ 60,00
<b>XX-476001</b>	<b>€ 58,00 x M*</b>
PARTI ESTERNE - ALTRE FINITURE	
<b>XX-4708/E</b>	<b>€ 60,00 x M*</b>
<b>XX-476001</b>	<b>€ 58,00 x M*</b>

**4708/E + 476001 + 054027**

[parte esterna] [maniglia] [parte incasso]

**RUBINETTO D'ARRESTO 3/4"**

> vitone ceramico 90°  
> ingressi da 3/4"  
> cod. B1 = rosso fabrique

 055001  
€ 20,00  
p. 151 - list. ricambi

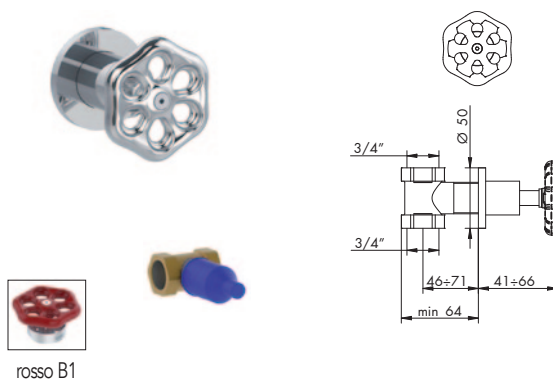

rosso B1

P. EST. - CROMATO / MAN. CROMATO o ROSSO B1	
01-4708/E	€ 60,00
01-476001 o B1-476001	€ 58,00
PARTE INCASSO	
054027	€ 67,00
<b>PREZZO TOTALE</b>	<b>€ 185,00</b>

P. EST. - CROMATO / MAN. IN ALTRA FINITURA	
01-4708/E	€ 60,00
<b>XX-476001</b>	<b>€ 58,00 x M*</b>
PARTI ESTERNE - ALTRE FINITURE	
<b>XX-4708/E</b>	<b>€ 60,00 x M*</b>
<b>XX-476001</b>	<b>€ 58,00 x M*</b>

**4740/E + 476001 + 654099**

[parte esterna] [maniglia] [parte incasso]

**PASSO RAPIDO 3/4"**

> vitone tradizionale  
> abbinare a saracinesca  
> ingressi da 3/4"  
> cod. B1 = rosso fabrique

 654067  
€ 43,00  
p. 151 - list. ricambi

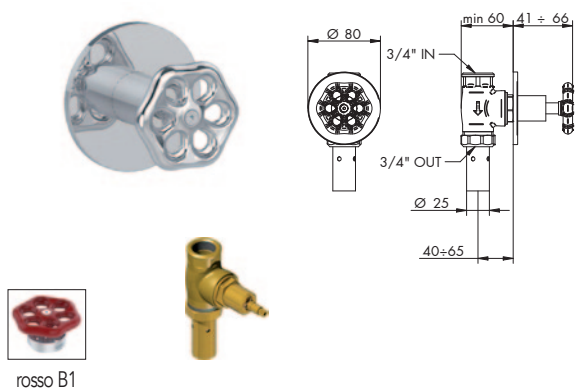

rosso B1

P. EST. - CROMATO / MAN. CROMATO o ROSSO B1	
01-4740/E	€ 85,00
01-476001 o B1-476001	€ 58,00
PARTE INCASSO	
654099	€ 114,00
<b>PREZZO TOTALE</b>	<b>€ 257,00</b>

P. EST. - CROMATO / MAN. IN ALTRA FINITURA	
01-4740/E	€ 85,00
<b>XX-476001</b>	<b>€ 58,00 x M*</b>
PARTI ESTERNE - ALTRE FINITURE	
<b>XX-4740/E</b>	<b>€ 85,00 x M*</b>
<b>XX-476001</b>	<b>€ 58,00 x M*</b>

**4740/E + 476001 + 654100**

[parte esterna] [maniglia] [parte incasso]

**PASSO RAPIDO 1"**

> vitone tradizionale  
> abbinare a saracinesca  
> ingressi da 1"  
> cod. B1 = rosso fabrique

 654067  
€ 43,00  
p. 151 - list. ricambi

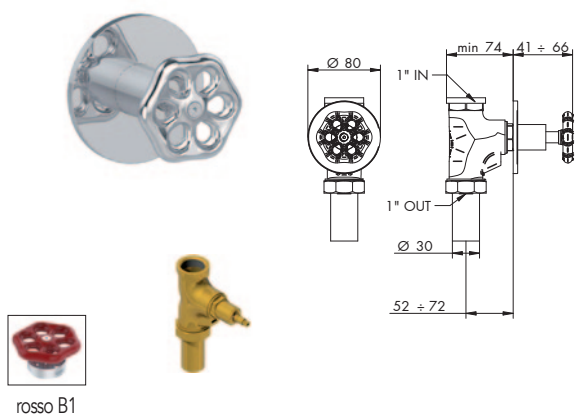

rosso B1

P. EST. - CROMATO / MAN. CROMATO o ROSSO B1	
01-4740/E	€ 85,00
01-476001 o B1-476001	€ 58,00
PARTE INCASSO	
654100	€ 114,00
<b>PREZZO TOTALE</b>	<b>€ 257,00</b>

P. EST. - CROMATO / MAN. IN ALTRA FINITURA	
01-4740/E	€ 85,00
<b>XX-476001</b>	<b>€ 58,00 x M*</b>
PARTI ESTERNE - ALTRE FINITURE	
<b>XX-4740/E</b>	<b>€ 85,00 x M*</b>
<b>XX-476001</b>	<b>€ 58,00 x M*</b>

RICAMBI IMMEDIATI



**XX = CODICE FINITURA RICHIESTA:** per identificare codice corretto vedi pag. 26  
**M\* = MOLTIPLICATORE:** per calcolare il prezzo delle altre finiture vedi tabella pag. 26

4732/2/E + 476001 + 035212

[parte esterna] [maniglia] [parte incasso]

SARACINESCA

> attacchi da 3/4"  
> cod. B1 = rosso fabrique

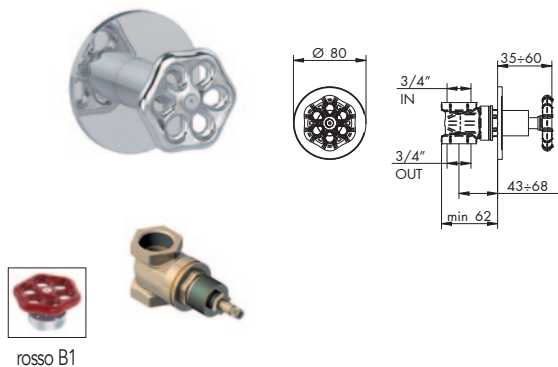

P. EST. - CROMATO / MAN. CROMATO o ROSSO B1		P. EST. - CROMATO / MAN. IN ALTRA FINITURA	
01-4732/2/E	€ 75,00	01-4732/2/E	€ 75,00
01-476001 o B1-476001	€ 58,00	XX-476001	€ 58,00 x M*
<b>PARTE INCASSO</b>		<b>PARTI ESTERNE - ALTRE FINITURE</b>	
035212	€ 48,00	XX-4732/2/E	€ 75,00 x M*
<b>PREZZO TOTALE</b>	<b>€ 181,00</b>	XX-476001	€ 58,00 x M*

0133/L

SIFONE LAVABO A BOTTIGLIA HI TECH 1"1/4

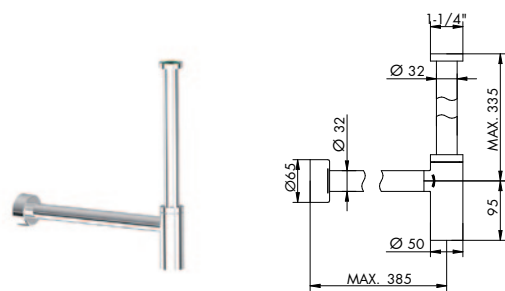

CROMATO		ALTRE FINITURE	
01-0133/L	€ 149,00	XX-0133/L	€ 149,00 x M*

0136/U

SCARICO UNIVERSALE TONDO STOP&GO 1"1/4

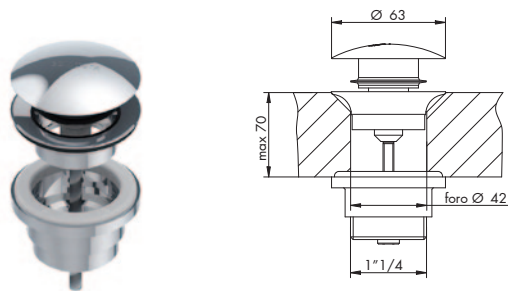

CROMATO		ALTRE FINITURE	
01-0136/U	€ 58,00	XX-0136/U	€ 58,00 x M*

020

RUBINETTO SOTTOLAVABO CON FILTRO

> attacco a parete da 1/2"  
> per collegamento flessibili 3/8" o tubetti Ø10  
> filtro interno per raccolta macro impurità

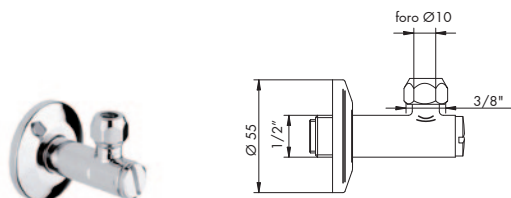

CROMATO		ALTRE FINITURE	
01-020	€ 20,00	XX-020	€ 20,00 x M*

029

TUBETTO CON CALOTTA 1/2" F

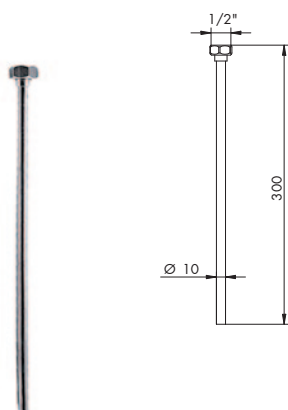

CROMATO		ALTRE FINITURE	
01-029	€ 11,00	XX-029	€ 11,00 x M*

PER SOLUZIONI ALTERNATIVE, CONSULTARE LISTINO RUBINETTERIA DA PAG. 707, SEZIONE COMPLETA ACCESSORI RUBINETTERIA.

FOR ALTERNATIVE SOLUTIONS, SEE THE "RUBINETTERIA" PRICE LIST FROM PAGE 707, TO LOOK AT THE COMPLETE "ACCESSORI RUBINETTERIA" COLLECTION.

#### PROGETTO SU MISURA: RICHIESTE SPECIALI

I tecnici di Bellosta Rubinetterie sono, inoltre, a disposizione di architetti e designers, per offrire un servizio esclusivo: personalizzazioni di elementi in funzione di specifiche richieste estetiche o problematiche legate a vincoli progettuali, verifica della fattibilità attraverso opportuni studi CAD e sviluppo del disegno tecnico del prodotto speciale richiesto.

Per informazioni e richieste PROGETTI SU MISURA:  
ufficiotecnico@bellostarubinetterie.com

#### PROGETTO SU MISURA: SPECIAL REQUESTS

Engineers Bellosta Rubinetterie are also available to architects and designers, to offer an exclusive service: customizations of items according to specific aesthetic requirements or issues related to design constraints, verification of the feasibility studies and development through appropriate CAD technical design the required special product. For information and requests "SU MISURA" PROJECTS:  
ufficiotecnico@bellostarubinetterie.com

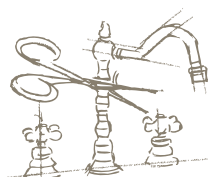

progetto  
"sumisura."

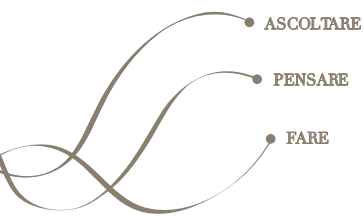

ASCOLTARE, PENSARE, FARE è la formula che abbiamo scelto per descrivere l'attenzione con cui interpretiamo i desideri del cliente, elaboriamo soluzioni ed esprimiamo proposte che ne soddisfino i gusti e le esigenze. Con lo stesso spirito, con lo stesso entusiasmo, oggi come oltre cinquantotto anni fa.

LISTEN, THINK, ACT is the philosophy that we use to describe the attention by which we interpret the wishing of the client, we find solution and make proposal for meet the taste and exigent. With the same mind and passion, today like more than fifty-eight years ago.

---

© 2020 Bellosta Rubinetterie. Tutti i diritti riservati.

GRAPHIC:  
Roberta Teruggi

CONCEPT:  
aCB

---

BELLOSTA CARLO & C. RUBINETTERIE Srl  
Via S. Botticelli, 12/14 | 28024 Briga Novarese (No) Italia  
Ingresso showroom: Largo Carlo Bellosta | Briga Novarese (No) Italia  
Atelier Milano: Via Montenapoleone, 22  
Atelier Roma: Piazza di Spagna, ingresso Via Gregoriana 23

T +39 0322 956 425 | 0322 912 330 | 0322 946 84  
F +39 0322 955 368 | [info@bellostarubinetterie.com](mailto:info@bellostarubinetterie.com)  
Export department: [estero@bellostarubinetterie.com](mailto:estero@bellostarubinetterie.com)

Follow us on facebook, youTube, linked in, twitter, pinterest, instagram, houzz

Visit our website on [bellostarubinetterie.com](http://bellostarubinetterie.com)

---

SPECIAL THANKS TO:  
Florim | [www.florim.com](http://www.florim.com)

